



Training and  
Support

# 2018-2019 *FIRST*<sup>®</sup> Tech Challenge Game Manual Part 2

## ROVER RUCKUS



Presented By **Qualcomm**

[www.firstinspires.org](http://www.firstinspires.org)

200 BEDFORD STREET ■ MANCHESTER, NH 03101



FOR INSPIRATION & RECOGNITION OF SCIENCE & TECHNOLOGY

## Sponsor Thank You

Thank you to our generous sponsors for your continued support of the *FIRST*® Tech Challenge!

***FIRST*® Tech Challenge  
Season Presenting Sponsor**

**Qualcomm**

***FIRST*® Tech Challenge  
Official Program Sponsor**

***Rockwell  
Collins***

***FIRST*® Tech Challenge  
Official 3D Augmented Reality/  
Virtual Reality Sponsor**



## Volunteer Thank You

Thank you for taking the time to volunteer for a *FIRST*® Tech Challenge event. *FIRST*® and *FIRST*® Tech Challenge rely heavily on volunteers to ensure events run smoothly and are a fun experience for teams and their families, which could not happen without people like you. With over 5,500 teams competing yearly, your dedication and commitment are essential to the success of each event and the *FIRST* Tech Challenge program. Thank you for your time and effort in supporting the mission of *FIRST*!

Revision History		
Revision	Date	Description
1	8/21/2018	Limited Affiliate Partner Release
1.1	9/8/2018	<ul style="list-style-type: none"> <li>• Kickoff Release</li> <li>• Section 1.5.1 Pre-Match – Updated text to match number of game elements in parentheses.</li> </ul>
1.2	10/3/2018	<ul style="list-style-type: none"> <li>• Section 1.6.3 Game Specific Rules               <ul style="list-style-type: none"> <li>○ Updates to rule &lt;GS3&gt;.</li> <li>○ Added Rules &lt;GS10&gt; and &lt;GS11&gt;.</li> </ul> </li> </ul>
1.3	11/19/2018	<ul style="list-style-type: none"> <li>• Section 1.4 Game Definitions – Added definitions for Claimed and Completely Claimed.</li> <li>• Section 1.8 Rule Summary – Added rules &lt;GS10&gt; and &lt;GS11&gt; to rule summary.</li> </ul>

## Contents

Contents.....	3
Introduction.....	5
What is <i>FIRST</i> ® Tech Challenge? .....	5
<i>FIRST</i> Core Values .....	5
<i>Gracious Professionalism</i> ® .....	5
Gracious Professionalism for Volunteers.....	5
Youth Protection Program .....	5
Youth Protection Expectations and Guidelines.....	5
NOTICE OF NON-DISCRIMINATION .....	6
1.0 The Game .....	6
1.1 Introduction .....	6
1.2 Game Description .....	6
1.3 Playing Field Illustration .....	7
1.4 Game Definitions .....	8
1.5 Game Play .....	13
1.5.1 Pre-Match.....	13
1.5.2 Autonomous Period.....	14
1.5.3 Driver-Controlled Period .....	14
1.5.4 End Game .....	15
1.5.5 Post Match .....	15

1.5.6 Penalty Scoring .....	15
1.5.7 Flowchart of Match Play .....	16
1.6 Rules of Game Play .....	16
1.6.1 Safety Rules .....	16
1.6.2 General Game Rules .....	17
1.6.3 Game-Specific Rules .....	22
1.7 Scoring Summary .....	23
1.8 Rule Summary .....	24
Appendix A – Resources .....	28
Game Forum Q&A .....	28
FIRST Tech Challenge Game Manuals .....	28
FIRST Headquarters Pre-Event Support .....	28
FIRST Websites .....	28
FIRST Tech Challenge Social Media .....	28
Feedback .....	28
Appendix B - Field Details .....	29
Sample Field .....	29
Lander .....	30
Lander Support Bracket .....	30
Navigation Target .....	31
Crater .....	32
Appendix C – Game Elements .....	33
Minerals .....	33
Team Markers .....	33
Appendix D – Sample Field .....	34
Appendix E – Cargo Hold Scoring .....	35

## Introduction

---

### **What is FIRST® Tech Challenge?**

FIRST® Tech Challenge is a student-centered program that focuses on giving students a unique and stimulating experience. Each year, teams engage in a new game where they design, build, test, and program autonomous and driver operated robots that must perform a series of tasks. To learn more about FIRST® Tech Challenge and other FIRST® Programs, visit [www.firstinspires.org](http://www.firstinspires.org).

### **FIRST Core Values**

We express the FIRST® philosophies of *Gracious Professionalism®* and *Coopertition®* through our Core Values:

- **Discovery:** *We explore new skills and ideas.*
- **Innovation:** *We use creativity and persistence to solve problems.*
- **Impact:** *We apply what we learn to improve our world.*
- **Inclusion:** *We respect each other and embrace our differences.*
- **Teamwork:** *We are stronger when we work together.*
- **Fun:** *We enjoy and celebrate what we do!*

## **Gracious Professionalism®**

---

FIRST® uses this term to describe our programs' intent and *Gracious Professionalism®* is not clearly defined for a reason. It has different meanings to everyone. Some possible meanings of *Gracious Professionalism* include:

- Gracious attitudes and behaviors are win-win.
- Gracious folks respect others and let that respect show in their actions.
- Gracious Professionals make valued contributions in a way that is pleasing to others and to themselves.

In the end, *Gracious Professionalism®* is part of everyday life. When professionals use their knowledge graciously and individuals act with integrity and sensitivity, everyone wins, and society benefits.

Watch Dr. Woodie Flowers explain *Gracious Professionalism* in this [short video](#).

### **Gracious Professionalism for Volunteers**

It is a good idea to spend time going over this concept with volunteers. Provide volunteers with real-life examples of *Gracious Professionalism* in practice before, during, and after the event and recognize great *Gracious Professionalism* when you see it in action!

## **Youth Protection Program**

---

The FIRST YPP sets minimum standards recommended for all FIRST activities. Adults working in FIRST programs must be knowledgeable of the standards set by the FIRST YPP, as well as those set by the school or organization hosting their team.

### **Youth Protection Expectations and Guidelines**

Coaches and mentors should read and follow the [FIRST Youth Protection Program guide](#). Anything labeled as required is mandatory in the United States and Canada, and cannot be waived without approval from the FIRST Youth Protection Department. FIRST recommends that the standards set forth in the FIRST Youth

Protection Program guide be applied outside of the United States and Canada to the extent possible. At a minimum, local regulations regarding youth protection must be complied with.

Most up to date forms are available here: <http://firstinspires.org/resource-library/youth-protection-policy>

The US Screening process, the Canadian Screen process, Frequently Asked Questions (FAQ), and additional information are on the FIRST Youth Protection Program Website: <http://firstinspires.org/resource-library/youth-protection-policy>

### **NOTICE OF NON-DISCRIMINATION**

For Inspiration and Recognition of Science and Technology (FIRST®) does not discriminate based on race, color, national origin, sex, disability, age, status as a veteran who served in the military, religion, gender, gender identity, or gender expression in its programs and activities.

Keep updated at: <http://www.firstinspires.org/about/legal-notice>

## **1.0 The Game**

---

### **1.1 Introduction**

This document describes ROVER RUCKUS™ presented by Qualcomm® Incorporated, the FIRST® Tech Challenge game for the 2018-2019 season. *Teams* must comply with all rules and requirements stated in this document and in the Game Manual Part 1. Clarifications to the game rules are issued on the Question & Answer section of the forum at [ftcforum.usfirst.org](http://ftcforum.usfirst.org). Forum rulings take precedence over information in the game manuals.

### **1.2 Game Description**

*Matches* are played on a *Playing Field* initially set up as illustrated in Figure 1.3-1 below. Two *Alliances* – one “Red” and one “Blue,” composed of two *Teams* each – compete in each *Match*. The object of the game is to attain a higher *Score* than the opposing *Alliance* by descending from the *Lander*, collecting *Minerals* from the *Crater*, sorting and *Scoring Minerals* into the *Cargo Hold* of the *Lander*, performing *Autonomous* tasks, and navigating to specific parts of the *Playing Field*. The *Scoring Elements* for the game are 60 *Silver Minerals* and 90 *Gold Minerals*, and a *Team* supplied *Team Marker*. The game is played in two distinct periods: *Autonomous* and *Driver-Controlled*.

The *Match* starts with a 30-second *Autonomous Period* in which *Robots* operate using only pre-programmed instructions and sensor inputs. *Alliances* earn points by: (1) *Landing* – *Robots* lower themselves from the *Lander* onto the *Playing Field*; (2) *Sampling* – *Robots* identify the single *Gold Mineral* in each *Sample Field*; (3) *Claiming* – *Robots* place the *Team Marker* in their corresponding *Depot*; and (4) *Parking* – *Robots* that end the *Autonomous Period* in a *Crater* earn points.

The two-minute *Driver-Controlled Period* follows the *Autonomous Period*. During this period, *Teams* earn points for their *Alliance* by placing *Minerals* into their *Alliance’s Cargo Holds* and/or *Depot*. *Gold Minerals* must be placed in the *Gold Cargo Hold* and *Silver Minerals* into the *Silver Cargo Hold* to *Score*. Either *Mineral* in the *Depot* earns points for the *Alliance*.

The final 30 seconds of the *Driver-Controlled Period* is called the *End Game*. In addition to the previously listed *Driver-Controlled Period Scoring* activities, *Alliances* earn points by (1) *Latching* onto the *Lander* and (2) *Parking In* or *Completely In* any *Crater*.

### 1.3 Playing Field Illustration

The following illustrations identify the *Game Elements* and gives a general visual understanding of the *Playing Field*. Teams should refer to [andymark.com/FTC](http://andymark.com/FTC) for the exact *Game Element* dimensions. The official *Playing Field* documents including the official Field Setup Guide are available at <https://tinyurl.com/ftcgame>. Please note: *Playing Field Wall* heights may be different depending on the manufacturer. Wall height measurements are in the official Field Setup Guide. Across the season, *Teams* may attend events that use *Playing Field Walls* from different manufacturers, please incorporate that into the design of your *Robot*.

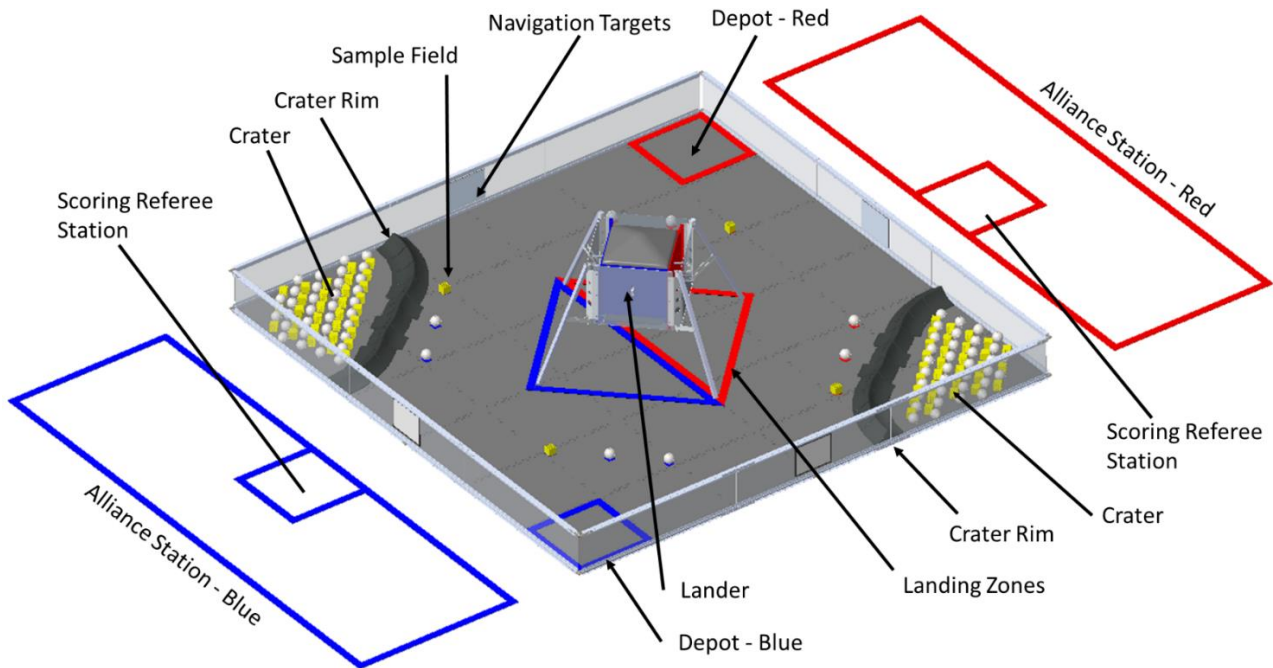

Figure 1.3-1 – Isometric view of the *Playing Field*

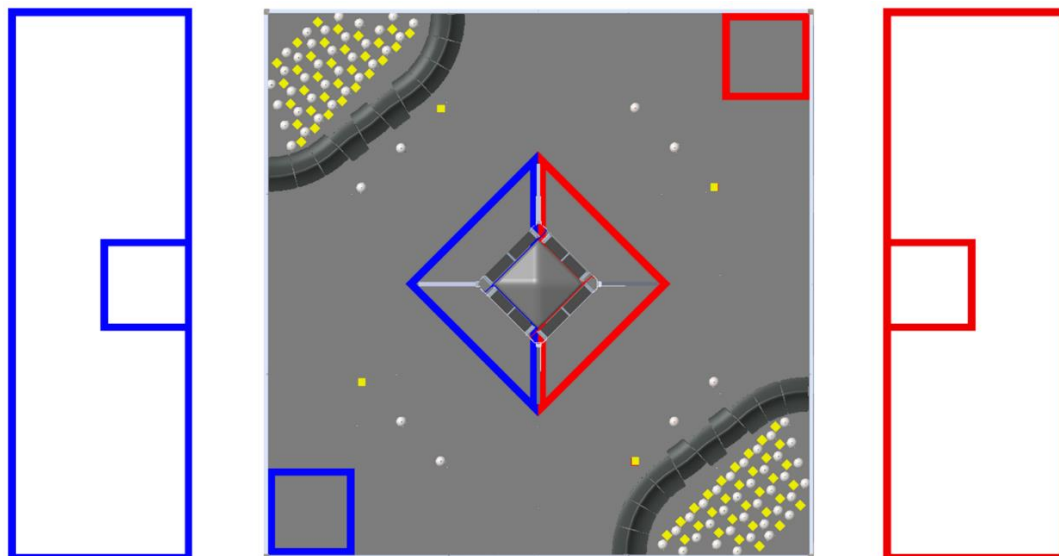

Figure 1.3-2 – Overhead view of the *Playing Field*

## 1.4 Game Definitions

The following definitions and terms are used in ROVER RUCKUS<sup>SM</sup> presented by Qualcomm® Incorporated:

**Alliance** – A grouping of two *Teams* that work together for a given *Match*. *Alliances* are designated as either “Red” or “Blue.”

**Alliance Station** – The designated “Red” or “Blue” *Alliance Area* adjacent to the *Playing Field* where the *Drivers* and *Coach* stand during a *Match*. *Station One* is the *Alliance Station* closest to the audience.

**Area** – The space defined by the vertical projection of the outside edge of a region’s boundary (for example, gaffers tape, goal, *Playing Field Wall*). The boundary element (tape, wall, markings, etc.) is considered to be part of the *Area* for the purposes of determining *Inside* and *Outside*.

**Autonomous Period** – A thirty-second period in which the *Robots* operate and react only to sensor inputs and to commands pre-programmed by the *Team* onto the onboard *Robot* control system. Human control of the *Robot* is not permitted during this time.

**Block / Blocking** – Preventing an opposing *Alliance Robot* from accessing an *Area* or *Alliance-specific Game Element* or all remaining *Alliance-neutral Game Elements* for an extended period by obstructing ALL paths of travel to the object or *Area*. Active defense played by a *Robot* shadowing an opposing *Alliance Robot* that eliminates all paths of travel between the opposing *Alliance Robot* and an *Area* or *Alliance-specific Game Element* or all remaining *Alliance-neutral Game Elements* is considered *Blocking*, even though at any frozen point in time there is an open path. See also *Trap / Trapping* (which may be considered the same except it is from a *Game Element* or *Area* of the *Playing Field*).

**Cargo Holds** – Four *Areas* (two per *Alliance*) within the *Lander* where *Robots* deposit *Minerals* to *Score* points.

**Claimed** - A *Depot* is *Claimed* when a *Robot* has placed and released a *Team Marker* in its *Alliance’s Depot* during the *Autonomous Period*. Once successfully placed, the *Team Marker* does not have to remain in the *Depot* to earn the *Claiming Score*.

**Coach** – A student *Team* member or adult mentor designated as the *Drive Team* advisor during the *Match* and identified by wearing a “*Coach*” badge or identifying marker.

**Competition Area** – The *Area* where all the *Playing Fields*, *Alliance Stations*, scoring tables, on-deck queuing tables, event officials, and other tournament items relating to *Match* play are located. The *Team Pit Area* and practice *Playing Fields* are not part of the *Competition Area*.

**Completely Claimed** – A *Depot* is *Completely Claimed* when both *Robots* on an *Alliance* have placed and released their *Team Markers* in their *Alliance’s Depot* during the *Autonomous Period*. There is no requirement that both *Team Markers* must be in the *Depot* at the same time for the *Depot* to be *Completely Claimed*.

**Contaminant** - A *Mineral In* an incompatible *Cargo Hold* (for example, *Silver In* a *Gold Cargo Hold*).

**Control / Controlling** – An object is considered to be *Controlled* by a *Robot* if the object is following the movement of the *Robot*. Objects that are *Controlled* by a *Robot* are considered to be part of the *Robot*. See *Possess / Possessing* to learn about a related term. Examples include, but are not limited to:

- Carrying – holding *Game Elements Inside* or *Outside* of a *Robot*.
- Herding – pushing or impelling *Game Elements* to a desired location or direction that gains a strategic advantage beyond moving the *Robot* around the *Playing Field*.



- Holding – *Trapping* one or more *Scoring Elements* against a *Game Element*, *Playing Field Wall*, or *Robot* in an attempt to shield or guard them.
- Launching – propelling *Game Elements* into the air.

Examples of interaction with *Game Elements* that are not *Controlled* include, but are not limited to:

- Plowing – *Inadvertent* contact with *Game Elements* while in the path of the *Robot* moving about the *Playing Field*.
- Deflecting – *Inadvertent* contact with a launched *Game Element* as it bounces off a *Robot*.

**Crater** – An *Area* surrounded by the *Playing Field Wall* and the Outer edge of the *Crater Rim* into which the *Minerals* are placed prior to the start of a *Match*. There are two (2) *Craters* located in opposite corners of the *Playing Field*. See Figure 1.3-1 for the location of the *Craters*.

**Crater Rim** – An assembly of wedge-shaped pieces on the *Playing Field* that forms the outside edge of a *Crater*. A single *Crater Rim* piece measures approximately 7.6 inches wide x 9 inches long x 3 inches tall (193 mm x 229 mm x 76 mm).

**Deployed** - *Robot* is not *Latched* to the *Lander*.

**Depot** – A segment of the *Playing Field* that is bounded by red or blue tape where *Game Elements* may be deposited. The *Depots* are *Alliance* specific, there is one (1) *Depot* per *Alliance*.

**Disable / Disabled** – A *Robot* that is no longer active for the remainder of the *Match* due to a *Robot* failure or by the request of a referee. *Drive Teams* may not *Disable* a *Robot* without the permission of a Field Technical Advisor or referee. If a referee *Disables* a *Robot* during a *Match*, he/she will ask the *Team* to drive their *Robot* to a neutral position on the *Playing Field*, issue a stop command with the *Driver Station*, and place their *Driver Station* in a hands-off location on a tournament-provided structure or the *Alliance Station* floor.

**Disqualified / Disqualification / Disqualify** – A *Team* that is *Disqualified* from a *Match* will not receive credit for the *Match* (that is, no Ranking or TieBreaker points).

**Drive Team** – Up to three representatives (two (2) *Drivers* and one (1) *Coach*) from the same *Team*.

**Driver** – A pre-college student *Team* member responsible for operating and controlling the *Robot* and identified by wearing a tournament supplied “*Driver*” badge or identifying marker.

**Driver-Controlled Period** – The two-minute time period in which the *Drivers* operate the *Robots*.

**Driver Station** – Hardware and software used by a *Drive Team* to control their *Robot* during a *Match*. The *Driver Station* consists of an Android device, *FIRST* Tech Challenge supplied Android App, adapter cable(s), optional non-powered USB Hub (i.e., does not draw power from a DC power input port), an optional commercial off the shelf USB external battery connected to the USB Hub to charge the Android device at any time, and up to two controllers to drive the *Robot*. The only allowed controller models are the Logitech F310 Gamepad and the Xbox 360 Controller for Windows. The *Driver Station* also includes decorations and any components used to hold the above listed legal devices.

**End Game** – The *End Game* is a named period of time that is the last thirty seconds of the two-minute *Driver-Controlled Period*.

**End of the Period/Match** - The moment when the *Match* timer reaches 0:00.

**Game Element** – Any item *Robots* interact with to play the game. *Game Elements* for this year's game include: *Minerals*, *Crater Rims*, *Team Markers* and the *Lander*.

**In (Inside) / Completely In (Completely Inside)** – An object that has crossed into the upwards vertical (i.e., at a right angle to the *Playing Field Floor*) extension of a defined *Area*'s boundary is *Inside* the *Area*. An object that is entirely within the upwards vertical extension of a defined *Area*'s boundary is *Completely Inside* the *Area*. The boundary element (tape, wall, markings, etc.) is part of the *Area* for the purposes of determining *Inside* and *Outside*.

**Inadvertent** – An outcome that is not a planned strategy and not the predictable result of persistent or repeated actions.

**Inconsequential** – An outcome that does not influence *Scoring* or gameplay.

**Interference** - Interaction between opposing *Alliance Robots* that amplifies the difficulty of a *Scoring* activity. Actions that constitute *Interference* should not be considered illegal except as specified by a *Game Rule*.

**Lander** – The structure on the *Playing Field Floor* where *Robots* may begin the *Match* and includes the *Cargo Hold Scoring Areas* where *Robots* deposit *Minerals*. See Figure 1.3-1 for the location of the *Lander*.

**Lander Support Bracket** – An attachment point on the *Lander* where *Robots* may start *Supported* at the beginning of the *Match* and may *Latch* onto during the *End Game*. There are four (4) *Alliance* specific *Lander Support Brackets*.

**Landing Zone** – A triangular *Area* underneath the *Lander* defined by the red or blue tape.

**Latched** – A *Robot* is considered *Latched* when it is *Completely Supported* by the *Lander Support Bracket* on the *Lander* and is not in contact with any other *Game Element*, *Robot*, or the *Playing Field Floor*. Incidental contact with *Scoring Elements*, the *Lander* sides or legs is allowed (for example, *Possession of Scoring Elements* is allowed). *Latching* is evaluated and *Scored* by earthlings. *Teams* are encouraged to make these actions obvious and unambiguous.

**Match** – A head-to-head competition between two *Alliances*. A *Match* consists of a thirty-second *Autonomous Period* followed by a two-minute *Driver-Controlled Period* for a total time of two minutes and thirty seconds.

**Minerals** – *Scoring Elements* for this year's game. There are two kinds of *Minerals*:

- *Silver*: White, spherical shaped objects.
- *Gold*: Yellow, cube shaped objects.

**Navigation Targets** – Four unique images mounted on the *Playing Field Walls* (one image per wall) that *Robots* can use to navigate around the *Playing Field*. Images are printed on standard letter size paper for the tournament location, 8 1/2 inch x 11 inch (216 mm x 279 mm) or A4 (210 mm x 297 mm) paper.

**Off** – Not physically in contact with or *Supported* by an object, surface, etc. Objects that are *Off* are also considered *Completely Off*.

**On / Completely On** – An object that is physically in contact with and at least partially *Supported* by an object, surface, etc. is considered *On*. An object that is entirely *Supported* by another object, surface, etc. is *Completely On*.

**Out / Outside** – An object that has not crossed into any part of a defined *Area* is *Outside* the *Area*.

**Park / Parked** – The condition where a *Robot* is motionless.

**Penalty** – The consequence imposed for a rule or procedure violation that is identified by a referee. When a *Penalty* occurs, points will be awarded to the *Alliance* that did not incur the *Penalty*. *Penalties* are further defined into *Minor Penalties* (ten points) and *Major Penalties* (forty points). *Penalties* may also escalate to issuing of a *Yellow Card* or *Red Card* as a result of a continued occurrence of a rule violation and upon discretion of the Referee.

**Yellow Cards and Red Cards** – In addition to rule violations explicitly listed in section 1.6, *Yellow Cards* and *Red Cards* are used in the *FIRST* Tech Challenge to manage *Team* and *Robot* behavior that does not align with the mission of *FIRST*. *Yellow* and *Red Cards* are not limited to just the *Competition Area*. *Teams* that display egregious behavior in the pit area, judging rooms, stands, or any other location of the tournament can be issued a yellow or red card for egregious behavior.

Egregious or repeated (3 or more) *Robot* or *Team* member behavior at the tournament can result in a *Yellow* and/or *Red Card*. *Yellow Cards* are additive, meaning that a second *Yellow Card* is automatically converted to a *Red Card*. A *Team* is issued a *Red Card* for any subsequent incident in which they receive an additional *Yellow Card*, for example, earning a second *Yellow Card* during a single *Match*

### **Yellow and Red Cards at the Competition Field**

The Head Referee may assign a *Yellow Card* as a warning, or a *Red Card* for *Disqualification* in a *Match*. A *Yellow Card* or *Red Card* is signaled by the Head Referee standing in front of the *Team's Alliance Station* and holding a yellow card and/or red card in the air.

To issue the second *Yellow Card*, the Head Referee will stand in front of the *Team's Alliance Station* and hold a yellow card and red card. The Head Referee will signal the second *Yellow Card* after the *Match* has ended.

A *Team* that has received either a *Yellow Card* or a *Red Card* carries a *Yellow Card* into following *Matches*, except as noted below. A *Red Card* results in *Match Disqualification*. Multiple *Red Cards* may lead to tournament *Disqualification*. Once a *Team* receives a *Yellow Card* or *Red Card*, the *Team* number is presented with a yellow background on the audience screen at the beginning of all following *Matches*. This is a reminder to the *Team*, referees, and audience the *Team* carries a *Yellow Card*.

*Yellow Cards* do not carry over from the *Qualification Matches* to the *Elimination Matches*. During the *Elimination Matches*, *Yellow* and *Red Cards* count against the entire *Alliance*, not to a specific *Team*. If a *Team* receives a *Yellow Card* or *Red Card*, it results in the entire *Alliance* receiving the *Yellow Card* or *Red Card* for that *Match*. If two different *Teams* on the same *Alliance* are issued *Yellow Cards*, the entire *Alliance* is issued a *Red Card*. A *Red Card* results in zero (0) points for that *Match*, and the *Alliance* loses the *Match*. If both *Alliances* receive *Red Cards*, the *Alliance* which committed the action earning the *Red Card* first chronologically loses the *Match*.

*Yellow* and *Red Cards* may also be issued off the competition field. For details please make sure to read the Tournament Rules outlined in section 4.3 of the [Game Manual Part 1](#).

**Pin / Pinning** – Preventing the movement in all directions of an opposing *Alliance Robot* while it is in contact with the *Playing Field Wall*, one or more *Game Elements*, or another *Robot*.

**Playing Field** – The part of the *Competition Area* that includes the 12 ft. x 12 ft. (3.66 m x 3.66 m) field and all the *Game Elements* described in the official field documents. From the audience viewpoint, the *Red Alliance Station* is on the right side of the *Playing Field*.

**Playing Field Damage** – A physical change to a *Game Element* or *Playing Field* that affects game play or an action that causes harm to the playability of a *Game Element* or *Playing Field*.

For Example: Black tire marks on a *Game Element* is not considered *Playing Field Damage*. However, digging a hole larger than 1 inch (2.54cm) diameter (approximately the size of a US quarter) or a series of smaller holes into the *Playing Field Floor* is considered *Damage*.

**Playing Field Floor** – The surface of the *Tiles* that make up the base of the *Playing Field*.

**Playing Field Perimeter** – The outside face of the *Playing Field Wall*.

**Playing Field Wall** – An approximate 12 inches (0.3 m) tall, 12 ft. (3.66 m) long by 12 ft. (3.66 m) wide wall surrounding the *Playing Field Floor*. The height of the *Wall* will vary depending on which *Playing Field Wall* is being used at the event. *Robots* should be built to interact with all legal perimeters.

**Possess / Possessing** – An object is in *Possession* by a *Robot* if, as the *Robot* moves or changes orientation (for example, moves forward, turns, backs up, spins in place), the object remains in approximately the same position relative to the *Robot*. Objects in *Possession* of a *Robot* are considered to be *Controlled*, and they are part of the *Robot*. See also *Control/Controlling*.

**Pre-Load** - A *Game Element* that a *Drive Team* positions during pre-*Match* setup so that it is *Possessed* by a *Robot* at the start of the *Autonomous Period*.

**Robot** – A mechanism that has passed *Robot* inspection and a *Drive Team* places on the *Playing Field* prior to the start of a *Match*. A detailed definition of *Robot* is in the *Robot* rules section in Game Manual Part 1.

**Sample Field** – Three (3) positions on the *Playing Field Floor* that are in front of each *Robot* starting location onto which the *Samples* are placed prior to the start of a *Match*. Each position is defined by a red or blue taped *Area*.

**Samples** – Two (2) *Silver* and one (1) *Gold Minerals* that are randomly placed onto each *Sample Field* prior to the start of a *Match*.

**Scoring / Score** – *Robots* earn points for their *Alliance* by interacting with *Scoring Elements* and *Parking* in specific *Areas* of the *Playing Field*. *Scoring Elements* are considered to be *Scored* when they are placed in the appropriate location and are no longer in contact with a *Robot* from the corresponding *Alliance*. The *Scoring* achievements and their point values are described in section 1.5.

**Scoring Elements** – Objects that *Robots* manipulate to earn points for their *Alliance*. The *Scoring Elements* for ROVER RUCKUS<sup>SM</sup> are *Minerals and Team Markers*.

**Scoring Referee Station** – The designated “Red” or “Blue” *Area Inside* an *Alliance Station* where the *Scoring Referee* sits or stands during a *Match*.

**Stop Playing The Game** - A *Robot* that is *Parked* for the remainder of the *Match* period.

**Support / Supported / Completely Supported** – A *Robot* is *Supported* by an object if that object is bearing at least some of the weight of the *Robot*. If the object is bearing all the *Robot*'s weight, the *Robot* is *Completely Supported* by the object.

**Team** – Mentors, supporters, and pre-college-aged students affiliated with an entity registered with *FIRST* and for the competition.

**Team Marker** – A *Team* provided *Scoring Element*. A detailed definition of *Team Marker* is in section 8.4 of the Game Manual Part 1. Compliance with construction rules will be verified during *Robot Inspection*.

**Tile** – The approximately 24 inch x 24 inch (0.61 m x 0.61 m) foam rubber mat, 36 of which make up the *Playing Field Floor*.

**Trap / Trapping** – Preventing an opposing *Alliance Robot* from escaping a constrained *Area* of the *Playing Field* or from a *Game Element* for an extended period of time by obstructing all paths of travel from the object or *Area*. See also *Block / Blocking* (which may be considered the same except it is to a *Game Element* or *Area* of the *Playing Field*).

## 1.5 Game Play

Prior to the start of the *Match*, *Drive Teams* perform some basic *Robot* setup steps that are described in section 1.5.1. *Matches* are made up of several periods totaling two minutes and thirty seconds. There is a thirty-second *Autonomous Period*, followed by a two-minute *Driver-Controlled Period*. The last thirty seconds of the *Driver-Controlled Period* is called the *End Game*. When the *Match* is over and referees signal, *Drive Teams* collect their *Robots* and *Team Markers*, return *Game Elements* and *Flags*, and exit the *Competition Area*.

### 1.5.1 Pre-Match

Field personnel will place approximately half of the fifty-two (52) *Silver* and half of the eighty-six (86) *Gold Minerals* into each of the *Craters*. The *Silver* and *Gold* will be randomly mixed.

*Drive Teams* receive an *Alliance*-colored *Robot*-identification flag from field personnel. This flag must be securely mounted on the *Robot* as defined in the *Robot* rules.

*Minerals* are not *Pre-Loaded* onto the *Robot*. *Drive Teams* may *Pre-Load* one *Team Marker*.

The *Drive Team* must select one of the following starting locations for their *Robot*:

1. **Latched to the Lander** - *Robot* is *Completely Supported* by their *Alliance*-specific side of the *Lander* with the following constraints:
  - a. The *Robot* must be *Completely Supported* by the *Lander Support Bracket*. Incidental contact with the *Lander* walls or the legs is allowed.
  - b. The lowest point on a *Robot* and *Team Marker* can be no closer than four (4) inches (102 mm) from the *Playing Field Floor*.
  - c. When *Completely Supported* by the *Lander*, *Robots* must be within the 18 inch x 18 inch x 18 inch (45.7 cm x 45.7 cm x 45.7 cm) starting volume constraint.
2. **Deployed from the Lander** - *Robots* that start the *Match Deployed* are not eligible to earn the *Landing* achievement points. *Deployed Robots* are placed on the *Playing Field Floor* in any orientation with the following constraints:
  - a. The *Robot* must be *In* the *Landing Zone* within the vertical projection of the *Lander Support Bracket*. For example, a portion of the *Robot* must be directly beneath the *Lander Support Bracket*.
  - b. The *Robot* must start *Outside* the opposing *Alliance*'s *Landing Zone*.

After the *Robots* are either *Latched* or *Deployed*, and *Autonomous* programs have been initialized, Referees will give a setup complete signal to the *Drive Team*, signifying the following:

1. *Drive Teams* may no longer touch their *Robots* until the conclusion of the *Match*, and
2. *Drive Teams* may not touch their *Driver Stations* or controllers until the *Autonomous Period* has ended, except to start their *Autonomous* program with a single touch to the *Driver Station* Android device screen.
3. Prior to the start of the *Match*, Referees will place *Samples* in the *Sample Field*. Referees will randomly arrange two *Silver* and one *Gold* into a grouping. This grouping will be repeated in front of each *Robot* starting location.

### **1.5.2 Autonomous Period**

The *Match* starts with a thirty-second *Autonomous Period* where *Robots* are operated via pre-programmed instructions only. *Teams* are not allowed to control *Robot* behavior with the *Driver Station* or any other actions during the *Autonomous Period*. The *Driver Station* is placed in a hands-off location during the *Autonomous Period* so that it is evident that there is no human control of *Robots*. The only exception is to allow *Drive Teams* to start their *Robot* with a single start command issued on the *Driver Station* Android device using the built-in thirty-second timer. The *Autonomous Period* begins following a start countdown (for example, 3-2-1-go) by field personnel, signaling *Drive Teams* with *Robots* that plan to run an *Autonomous Op Mode* to issue a *Robot* start command with their *Driver Station*. Failure to adhere to this procedure may subject the *Team* and/or *Alliance* to a *Penalty* as specified in the game rules in Section 1.6.2.

The *Autonomous Score* is based on completing tasks during the *Period*. Points are awarded for the following achievements:

1. **Landing** – *Robots* lower themselves from the *Lander* onto the *Playing Field Floor*. Each *Robot* that is in contact with the *Playing Field Floor* and not in contact with the *Lander Support Bracket* will earn 30 points for their *Alliance*.
2. **Claiming** – Each *Robot* that successfully places their *Team Marker* In their *Alliance's Depot* will earn 15 points for their *Alliance*. The *Team Marker* may only be delivered by placing it into the *Depot*. Launching, shooting, throwing, etc. of a *Team Marker* is not allowed. If an *Alliance Completely Claims* their corresponding *Depot*, then descoring of *Minerals* by the *Opposing Alliance* will not be allowed from that *Depot* during the *Driver-Controlled Period*. *Completely Claimed Depots* are permanent for the *Match*.
3. **Parking** – Each *Robot* In a *Crater* at the *End of the Autonomous Period* will earn 10 points for their *Alliance*.
4. **Sampling** – Each *Sample Field* that has its *Gold Mineral* Out of the corresponding *taped Area* and the two (2) *Silver Minerals* remaining In their corresponding *taped Areas* will earn 25 points for the corresponding *Alliance*.

*Minerals* placed in the *Depot* or *Cargo Hold* during the *Autonomous Period* are Scored as described in section 1.5.3.

### **1.5.3 Driver-Controlled Period**

Directly following the end of the *Autonomous Period*, *Drive Teams* have five (5) seconds plus a "3-2-1-go" countdown to prepare their *Driver Stations* for the start of the *Driver-Controlled Period*. On the countdown

word "go," the *Driver-Controlled Period* starts and *Drive Teams* press their *Driver Station* start buttons to resume playing the *Match*.

The *Driver-Controlled Score* is based on completing tasks as outlined below. Points are awarded for the following achievements: *Minerals Scored* earn points as follows:

1. *Minerals Scored into the Depot* earn two (2) points each. *Minerals removed from the Depot* deduct two (2) points each.
2. *Gold Scored into the Gold Cargo Hold* on the *Lander* earns five (5) points.
3. *Silver Scored into the Silver Cargo Hold* on the *Lander* earns five (5) points.
4. *Minerals* placed into the wrong *Cargo Hold* (that is, *Gold* into *Silver* or *Silver* into *Gold*) on the *Lander* are considered *Contaminants* and *Score* zero (0) points.
5. To be considered *Scored* for either the *Depot* or a *Cargo Hold*, a *Mineral* must be *In* the volume defined by the *Scoring Area*. For the *Depots*, the volume is defined by the outer edge of the tape and extending infinitely upwards from the *Playing Field Floor*. For a *Cargo Hold*, the volume is defined by the 5 inner surfaces of the *Cargo Hold* and the horizontal extension of the upper edge of the clear panel on the outside of the *Cargo Hold*.

#### **1.5.4 End Game**

The last thirty seconds of the *Driver-Controlled Period* is called the *End Game*. *Driver-Controlled Period Scoring* can still take place during the *End Game*.

Points are awarded at the *End of the Match* for the following *End Game* achievements:

1. ***Robots Latched*** – Each *Robot* that *Deployed* during pre-*Match* setup or in the course of game play and is *Latched* onto either of their own *Alliance-specific Lander Support Brackets* at the *End of the Match* earns 50 points for their *Alliance*.
2. ***Robots Parked In any Crater*** – Each *Robot* that is *Parked In* any *Crater* at the *End of the Match* earns 15 points for their *Alliance*.
3. ***Robots Parked Completely In any Crater*** – Each *Robot* that is *Parked Completely In* any *Crater* at the *End of the Match* earns 25 points for their *Alliance*.

#### **1.5.5 Post Match**

After the *Match* ends, field personnel will finalize the *Score*. Referees will signal for the *Drive Teams* to enter the *Playing Field* and retrieve their *Robots* and *Team Markers*. *Drive Teams* should not step on the *Crater Rim* when retrieving their *Robots* and *Team Markers*. The *Drive Teams* should return *any Minerals* that are *Possessed* by the *Robot* to the *Playing Field* and return the *Alliance-colored Robot* identification flag to the field personnel. The *Playing Field* reset crew will set up the *Playing Field* for the next *Match*.

#### **1.5.6 Penalty Scoring**

*Penalty* points are added to the non-offending *Alliance's Score* at the end of the *Match*. *Minor Penalties* give the non-offending *Alliance* ten (10) points per occurrence. *Major Penalties* give the non-offending *Alliance* forty (40) points per occurrence.

### 1.5.7 Flowchart of Match Play

The following figure shows the flow of the *Match* and the actions taken on the *Driver's Station* Android device.

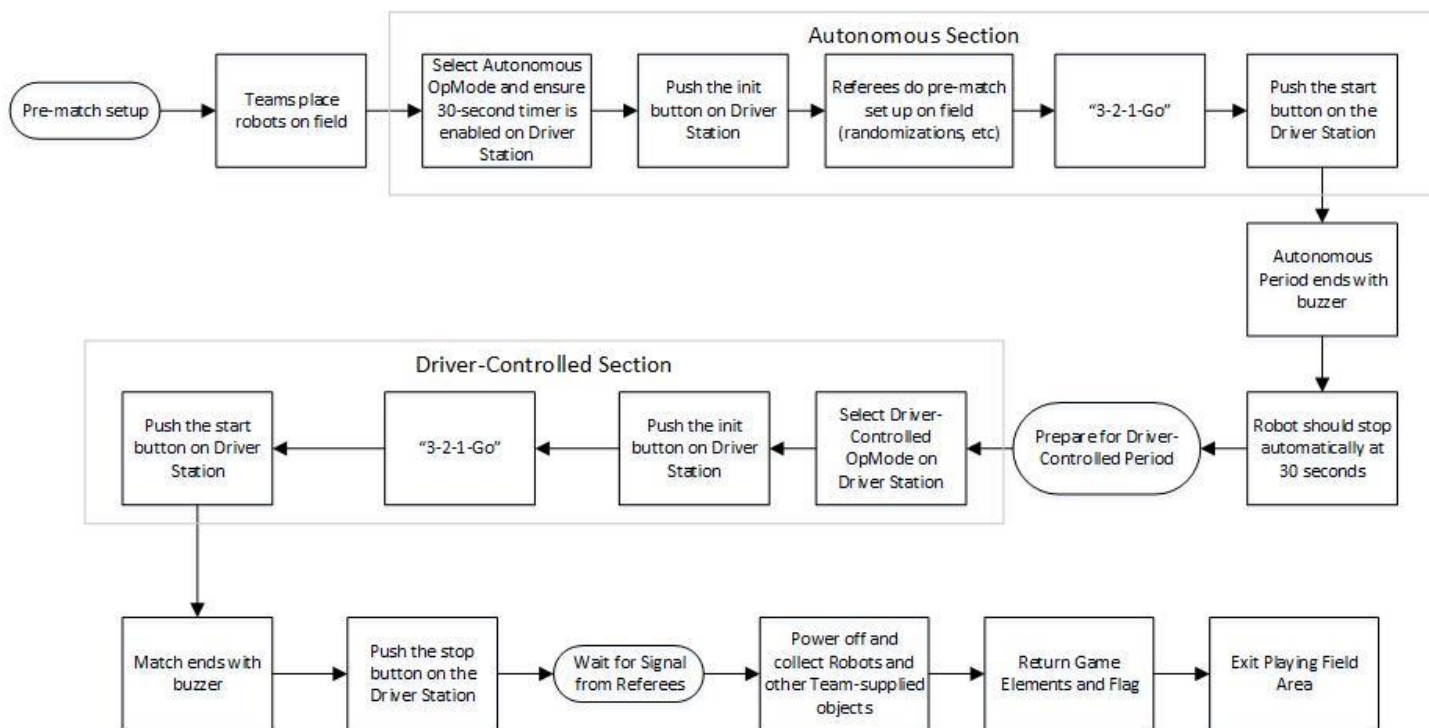

### 1.6 Rules of Game Play

Game play is restricted by the Safety rules (<S#>), the General rules (<G#>), and the Game-Specific rules (<GS#>). Other rules to pay close attention to are the *Robot* rules, *Team Marker* rules, the inspection rules, and the tournament rules defined in the Game Manual Part 1. Violation of rules may lead to *Penalties*, *Yellow Cards* and/or *Red Cards*, a *Disabled Robot*, *Disqualification* of the offending *Team* and/or *Alliance* from either a *Match* or the tournament. Rules apply to all periods of play unless specifically called out otherwise. If rules are in conflict, Safety rules take precedence over all rules and Game-Specific rules take precedence over General rules. The official *FIRST* Tech Challenge Question & Answer Forum rulings take precedence over all information in the game manuals.

#### 1.6.1 Safety Rules

**<S1> Unsafe Robot and Playing Field Damage** – If at any time the *Robot* operation is deemed unsafe or has damaged the *Playing Field* or another *Robot*, by the determination of the referees, the offending *Robot* may be *Disabled*, and the *Team* may be issued a *Yellow Card*. Re-inspection of the *Robot* is required before it may play another *Match*. Damage that requires significant repair and/or delays subsequent *Match* play is likely to escalate to a *Red Card*.

The intent of this rule is to immediately stop unsafe *Robot* actions or *Playing Field Damage* that is likely to persist with continued *Robot* operation. *Robots* that can continue safe operation without damaging the *Playing Field* will receive a warning and may continue to play the *Match*. *Robots* will be *Disabled* for unsafe operation or *Playing Field Damage* that occurs after the first warning for the tournament. Damage that affects game play is likely to escalate to a *Yellow Card*.



**<S2> Robot Extension Outside the Playing Field Perimeter** – If any portion of the *Robot* contacts anything *Outside* the *Playing Field Perimeter*, the *Team* will be issued a *Yellow Card* and it may be *Disabled* immediately for the remainder of the *Match*, unless allowed by Game-Specific rule(s) listed in Section 1.6.3. See the game definitions in section 1.4 for a complete description of the *Playing Field Perimeter*.

The intent of this rule is not to *Penalize* an *Alliance* for *Inadvertent*, safe *Robot* extension *Outside* the *Playing Field Perimeter*. Intentional *Robot* extension *Outside* the *Playing Field* is not permitted, except as allowed by game-specific rules listed in Section 1.6.3

**<S3> Safety Gear** – All members of the *Drive Team* are required to wear approved eye protection and shoes with closed-toes and a closed-back. If any member of the *Drive Team* is not wearing these safety items, the referee will issue a warning and if the situation is not remedied within thirty seconds, the offending member(s) of the *Drive Team* must leave the *Competition Area* for the remainder of the *Match* and may not be replaced by another *Team* member. Failure to comply with a request to leave the *Competition Area* violates rule <G28>.

### **1.6.2 General Game Rules**

**<G1> Drive Team** – Each *Drive Team* shall include up to two *Drivers* and one *Coach*. Electronic communications (cell phone, two-way radio, Wi-Fi, Bluetooth, etc.) by *Drive Team* members after an *Alliance* has been called from the queue to the *Playing Field* for its *Match* are not allowed. The first instance of violating this rule will result in a warning, with any following instances during the tournament resulting in a *Minor Penalty*. Items that may be mistaken by a casual observer as being in violation should not be brought to the *Playing Field*. The *Driver Station* is exempt from this rule but must be used only for operating the *Robot*.

**<G2> Pre-Match Robot Setup** - *Team* members cannot enter the *Playing Field* for any reason other than to place/retrieve their *Robots*. *Teams* may not measure, test, or adjust field or game elements prior to the start of a *Match*. Inspection of the *Playing Field* elements by *Team* members to determine *Scoring* is not allowed. Individuals and *Teams* that violate this rule will be subject to possible penalties that could include *Match Disqualifications* or even removal from the tournament.

**<G3> Pre-Match Robot Placement** – At the beginning of a *Match*, each *Alliance Robot* must be set up on the *Playing Field* according to section 1.5.1 Pre- Match in the Game Manual Part 2. After *Robots* are set up on the *Playing Field*, *Drive Teams* must stand *Completely* inside the *Alliance Station* at the location (Station one or Station two) specified by the Qualification *Match* schedule.

- a. During the Qualification *Matches*, the blue *Alliance Robots* are set up on the *Playing Field* first, unless the red *Alliance* waives their right to set up on the *Playing Field* second.
- b. During the Elimination *Matches*, the 3<sup>rd</sup> and 4<sup>th</sup> seeded *Alliance Robots* are set up on the *Playing Field* first, unless the higher seeded *Alliance* waives their right to set up on the *Playing Field* second. *Alliance* color doesn't change the seeding of a *Team* during the Elimination *Matches*. If the 4<sup>th</sup> seed defeats the 1<sup>st</sup> seed in the Semi-Finals, they will still have to place their *Robot* on the field first in the Finals because their seeding will be lower than the 2<sup>nd</sup> or 3<sup>rd</sup> seed.
- c. During Elimination *Matches*, 3 *Team Alliances* may only place *Robots* that are intended to compete in that *Match*. Once two *Robots* are placed for the two *Teams* competing in a *Match*, the *Alliance* cannot swap in the 3<sup>rd</sup> *Alliance's Robot* for a *Robot* already placed.

- d. *Teams* may implicitly waive their right to place their *Robots* on the *Playing Field* last by placing their *Robots* on the *Playing Field* before or with the opposing *Alliance*. There is no need to tell the referees; *Teams* waive their right by the act of placing their *Robots* on the *Playing Field*.
- e. *Teams* that unnecessarily delay the beginning of a *Match* and/or field reset will incur a *Minor Penalty* for each offense.

*Drive Teams* are expected to stage their *Robots* for a *Match*, and remove it from the *Playing Field* afterwards, safely and swiftly. *Drive Team* efforts that either intentionally or unintentionally delay the start of a *Match* or the *Playing Field* reset are not allowed. Examples include, but are not limited to:

- Late arrival to the *Playing Field*.
- *Robot* maintenance once on the *Playing Field*.

**<G4> Robot Starting Volume** – Before the start of a *Match*, each *Robot* in its starting location must not exceed a volume of 18 inches (45.7cm) by 18 inches (45.7cm) by 18 inches (45.7cm) unless otherwise allowed or restricted by Game Specific Rules detailed in Section 1.6.3. The *Alliance* identification flag and *Pre-Loaded Scoring Elements* may extend *Outside* the 18-inch (45.7cm) cube volume constraint. An offending *Robot* will be removed from the *Playing Field* for the length of the *Match*.

After the start of a *Match*, the *Robot* may extend in any dimension unless restricted by the Game-Specific rules detailed in Section 1.6.3.

**<G5> Robot Setup/Alignment** – *Teams* may align their *Robots* during Pre-*Match* setup if they do so with legal components that are part of the *Robot* and can be reset to be within the 18-inch (45.7cm) cube starting volume constraint. A single member of the *Drive Team* may also align the *Robot* by sight, assuming that he/she is next to the *Robot* and does not delay the start of a *Match*. A *Minor Penalty* will be assessed to the *Team* for violation of this rule.

**<G6> Alliance Station** – During a *Match*, the *Drivers* and *Coach* must remain *Completely Inside* their *Alliance Station*. The first instance of leaving the *Alliance Station* will result in a warning, with any following instances resulting in a *Minor Penalty*. Leaving the *Alliance Station* for safety reasons will not result in a warning or *Penalty*.

**<G7> Starting Game Play Early** – *Robots* that start play of the game (*Autonomous* or *Driver-Controlled Period*) prior to the start of a *Match Period* receive a *Minor Penalty*. Referees have the option of issuing a *Major Penalty* in place of the *Minor Penalty* if the early start results in a competitive advantage for the offending *Alliance*.

**<G8> Late Start of the Autonomous Period** – *Teams* participating in the *Autonomous Period* are expected to press the "start with 30-second" button on their *Driver Station* Android device and then place the *Driver Station* in a hands-off location without delay when field personnel signal the start of the *Autonomous Period*. A *Minor Penalty* is assessed for violating this rule. Referees have the option of issuing a *Major Penalty* in place of the *Minor Penalty* if the late start results in a competitive advantage for the offending *Alliance*.

**<G9> Robot Control During Autonomous Period** - During the *Autonomous Period*, *Drive Teams* may not directly or indirectly control or interact with *Robots* or *Driver Stations*. Early stopping of the *Robot* while running its *Autonomous* code is not allowed, except in cases of personal or equipment safety. A *Major Penalty* will be assessed for violating this rule.

**<G10> Stopping Game Play Late** – Robots that do not *Stop Playing The Game* at the end of the *Autonomous* or *Driver-Controlled Periods* when competition personnel or timer software announce the end of a *Match* period receive a *Minor Penalty* and the actions of the *Robot* occurring after the end of a *Match* period do not count towards their *Alliance's Score*. Referees have the option of issuing a *Major Penalty* in place of the *Minor Penalty* if the late stop results in a competitive advantage (other than *Scoring*) for the offending *Alliance*.

*Scoring Elements* that were launched before the *End of the Period* are eligible to be counted as *Scored*. Other *Robot Scoring* achievements that occur after the announced end of the *Autonomous Period* and before the start of the *Driver-Controlled Period* do not count towards the *Score* for the *Autonomous* or *Driver-Controlled Periods*. Referees may remove any *Scoring Elements* from a *Scoring Area* that are improperly *Scored* in this manner.

The intent of this rule is for *Robots* to *Stop Playing The Game* within a reasonable human reaction time following the start of the game sound (i.e., buzzer) signaling the *End of the Period*. *Drive Teams* should make their best effort to stop game play immediately when the *End of the Period* game sound begins. Before the consequences come into play, referees will use their discretion to give *Drive Teams* an approximate one second grace period following the conclusion of the game sound signaling the *End of the Period* for *Robots* to *Stop Playing the Game*.

**<G11> Drive Team Contact with the Playing Field or Robot** – During a *Match*, the *Drivers* and *Coaches* are prohibited from making contact with the *Playing Field*, any *Game Element*, or any *Robot*. The first instance of contact will result in a warning, with any following instances resulting in a *Minor Penalty*. Contact that affects *Scoring* and/or game play will result in issuance of a *Yellow Card* at the discretion of the referees. Contact with the *Playing Field*, a *Game Element*, or a *Robot* for safety reasons will not result in a warning or *Penalty*.

For example, a *Game Element* is launched from a *Robot* on the *Playing Field* and it *Inadvertently* hits a *Team* member in the *Alliance Station* and is deflected back onto the field. The *Team* would not receive a *Penalty* because the *Team* member was protecting him/herself (safety). However, if that same *Game Element* is caught and/or directed to a specific location on the *Playing Field*, the *Team* may be issued a *Penalty*.

**<G12> Autonomous to Driver-Controlled Period Transition** – At the conclusion of the *Autonomous Period*, *Robots* will remain in a hands-off state. Field personnel will not enter the field and will not touch *Robots* on the field during the *Autonomous* to *Driver-Controlled* transition. *Drive Teams* will have 5 seconds to pick up their *Driver Station*. The scoring system display will provide visual and audio cues for *Drive Teams* to pick up their *Driver Stations*. After the 5 seconds, there will be a 3-2-1 countdown and the *Driver-Controlled Period* of the *Match* will begin.

**<G13> Drive Team Coach Driver Station Control** – During the *Driver-Controlled Period*, *Robots* must be remotely operated only by the *Drivers* using the Gamepads connected to the *Team's Driver Station* and/or by software running on the on-board *Robot* control system. The first instance of *Coach* controlling a *Robot* (for example, operating a Gamepad) will result in a warning, with any following instances resulting in a *Major Penalty*. During the *Driver-Controlled Period*, *Drive Team Coaches* and/or *Drivers* are allowed to hold the *Team's Driver Station* Android device and interact with it to select an Op Mode, view information displayed on the screen, and initialize, start, stop, and reset the *Robot*.

**<G14> Certifying the Score at Match End** – Scores will be tracked by field personnel throughout the *Autonomous* and *Driver-Controlled Periods* of the *Match*. At the conclusion of the *Match*, the final *Score* will be certified as quickly as possible. A change in state of a *Game Element* or *Robot* at the end of the *Match* after its final *Score* is recorded will not change an already-recorded *Score*. *Scoring Elements* will not be recounted at the end of the *Match*.

**<G15> Robots Deliberately Detaching Parts** – Parts may not be deliberately detached from *Robots* during a *Match* or leave mechanisms on the *Playing Field* unless permitted by a *Game Specific Rule*. The consequence of deliberately detaching a part is a *Minor Penalty* if it does not *Block* an opposing *Alliance Robot*, *Alliance-specific Scoring Element* or *Scoring Area*. If a deliberately-detached component or mechanism affects game play by any *Robot*, the offending *Robot* will receive a *Major Penalty* and will be issued a *Yellow Card*. *Robot* parts that are released but remain connected by a tether are considered detached for the purposes of this rule.

Tethered components that move independent of the main *Robot* are considered a detached component and are illegal.

**<G16> Robots Grasping Game Elements** – *Robots* may not grab, grasp and/or attach to any *Game Element*, *Robot*, or structure other than *Scoring Elements*, unless specifically allowed by game-specific rule(s) listed in Section 1.6.3. The first instance will result in a warning with any following violations resulting in a *Major Penalty*.

**<G17> Destruction, Damage, Tipping, etc.** – Strategies and/or mechanisms aimed solely at the destruction, damage, tipping over, or entanglement of *Robots* or *Game Elements* are not in the spirit of the *FIRST* Tech Challenge and are not allowed. However, *FIRST* Tech Challenge games are highly interactive and *Robot-to-Robot* contact and defensive game play should be expected. Some tipping, entanglement, and damage may occur as a part of normal game play. If the tipping, entanglement, or damage is ruled to be deliberate or chronic, the offending *Team* will receive a *Major Penalty* and a *Yellow Card*.

**<G18> Pinning, Trapping, or Blocking Robots** – A *Robot* cannot cause an opposing *Alliance Robot* to become *Pinned*, *Trapped*, or *Blocked* for more than five seconds. If a referee determines this rule is violated, the offending *Alliance* will receive a *Minor Penalty* for every five seconds that they are in violation. If a referee declares a *Pinning*, *Trapping*, or *Blocking* warning during the *Match*, the offending *Robot* must immediately move away at least 3 feet (0.9 m), approximately 1.5 floor *Tiles*, from the *Pinned*, *Trapped*, or *Blocked Robot*.

The intent of this Rule is that *Drive Teams* begin to immediately move their *Robots* away and have a five second grace period to move the required distance, and not that they are permitted to intentionally *Block* for up to five seconds.

A *Robot* cannot incur this type of *Penalty* during the *Autonomous Period* unless it is determined by the Referee to be part of a deliberate strategy and will be penalized as described above. If the violation happens during the *Autonomous Period*, the first action done by the offending *Robot* during the *Driver-Controlled Period* must be to move away from the *Pinned*, *Trapped*, or *Blocked Robot* or a *Minor Penalty* will be assessed immediately and again for every five-seconds that they are in violation. Game-specific rule(s) listed in Section 1.6.3 that further define *Pinning*, *Trapping*, or *Blocking* take precedence over this general game rule.

**<G19> Forcing an Opponent to Break a Rule** – The actions of an *Alliance* or their *Robots* shall not cause an opposing *Alliance* or *Robot* to break a rule and thus incur *Penalties*. Any forced rule violations committed by the affected *Alliance* shall be excused, and no *Penalties* will be assigned.

**<G20> Removing Game Elements from the Playing Field** – *Robots* may not deliberately remove *Game Elements* from the *Playing Field* during a *Match*. *Game Elements* that *Inadvertently* fall *Outside* the *Playing Field* will be returned to the *Playing Field* by field personnel at the earliest safe and convenient opportunity at a non-*Scoring* location approximately where it left the field. *Game Elements* removed from the *Playing Field* in an attempt to *Score* are also not subject to this *Penalty*. *Teams* deliberately removing *Game Elements* from the *Playing Field* will incur a *Minor Penalty* per *Game Element* removed from the *Playing Field*. Game-specific

rule(s) listed in Section 1.6.3 that allow the removal of specified *Scoring Elements* from the *Playing Field* take precedence over this general game rule.

**<G21> Scoring Elements in Contact with Robots** – *Scoring Elements* in a *Scoring Area* that are in contact with or *Controlled* by a *Robot* on the corresponding *Alliance* for the *Scoring Area* have zero *Score* value. Game-specific rule(s) listed in Section 1.6.3 that allow *Robot* contact with *Scoring Elements* take precedence over this general game rule.

**<G22> Post-Match Removal of Game Elements from Robots** – *Robots* must be designed to permit easy removal of *Game Elements* from the *Robot* after the *Match*. *Robots* should also be able to be removed from the *Playing Field* without damaging the *Playing Field*. A *Minor Penalty* will be assessed for violations of this rule.

The intent of this rule is to have timely removal of *Robots* from the *Playing Field* following a *Match*.

*Drive Teams* are expected to stage their *Robots* for a *Match*, and remove them from the *Playing Field* afterwards, safely and swiftly. *Drive Team* efforts that either intentionally or unintentionally delay the start of a *Match* or the *Playing Field* reset are not allowed. Examples include, but are not limited to:

- Failing to exit the *Playing Field* once instructed by a Referee.
- Failing to remove *Driver Stations* in a timely manner.

**<G23> Robot Manipulation of Scoring Elements** – *Scoring Elements* that are *Controlled* or *Possessed* by a *Robot* are considered to be part of the *Robot* except when determining the location of the *Robot*.

For Example: If a *Robot* possesses a *Scoring Element*, and only that *Scoring Element* breaks the plane of a *Scoring Area*, the *Robot* does not receive points for being in that *Area*.

**<G24> Robot or Scoring Elements In Two or More Scoring Areas** – *Robots* or *Scoring Elements* that are *In* two or more *Scoring Areas* earn points only for the highest value achievement. If the achievement values are equal, only one achievement counts as *Scored*. Exceptions to this general rule may be specified in the Game Play section (1.5) or in the game-specific rules.

**<G25> Disabled Robot Eligibility** - If a referee *Disables* a *Robot*, it will not be eligible to *Score* or earn points for the remainder of the *Match*. A *Disabled Robot* (whether referee induced or failure) does not earn *Penalties* after becoming *Disabled*.

**<G26> Playing Field Tolerances** – Tournament provided *Playing Field* and *Game Elements* will start each *Match* with tolerances that may vary by as much as +/-1.0 inch (2.5 cm). *Teams* must design their *Robots* accordingly.

**<G27> Match Replay** – *Matches* are replayed at the discretion of the Head Referee only for a failure of a non-*Team* supplied *Game Element* or verified Wi-Fi interference that was likely to have impacted which *Alliance* won the *Match*.

Unexpected *Robot* behavior will not result in a *Match* replay. *Team*-induced failures, such as low battery conditions, processor sleep time-outs, *Robot* mechanical, electrical, software, or communication failures, etc. are NOT valid justifications for a replaying of a *Match*.

**<G28> Egregious Behavior** – Egregious *Robot* or *Team* member behavior at the *Playing Field*, as determined by the referees, will result in a *Major Penalty* and issuance of a *Yellow Card* and/or *Red Card*. Subsequent violations will result in *Team Disqualification* from the tournament. Egregious behavior includes, but is not limited to, repeated and/or flagrant violation of game rules, unsafe behavior or actions, and uncivil behavior towards *Drivers*, *Coaches*, competition personnel, or event attendees.

**<G29> Illegal Usage of Game Elements** - *Robots* may not deliberately use *Game Elements* in an attempt to ease or amplify the difficulty of any *Scoring* or game activity. A *Major Penalty* will be assessed for violations of this rule. Continued violations of this rule will escalate to *Yellow Cards* quickly.

**<G30> Inadvertent and Inconsequential** - *Robot* actions that violate a rule may be ruled at the referee's discretion to be *Inconsequential* and *Inadvertent* and will not be *Penalized*.

### 1.6.3 Game-Specific Rules

**<GS1> Drive Teams Touching Robots or Driver Stations after Sample Randomization** – *Drive Teams* are not allowed to touch or interact with their *Robots* or *Driver Stations* once field personnel have begun the randomization process. If this occurs, a *Minor Penalty* will be assessed, and the affected *Robot* is not eligible to *earn the Sample Score* in the *Autonomous Period*. This *Penalty* only affects the offending *Team*. The non-offending *Alliance Partner Robot* remains eligible for the *Sample Scoring* achievement.

**<GS2> Autonomous Period Robot Interference** – *Robots* may not *Interfere* with the opposing *Alliance's* *Scoring* attempts or *Sample Field* during the *Autonomous Period*. A *Major Penalty* will be assessed for violating this rule. *Robots* attempting to *Score* in a *Crater* are exempt from this rule.

The intent of this rule is to allow *Robots* to *Score* their *Autonomous points* without defensive play by the opposing *Alliance*. *Inadvertent* and *Inconsequential* actions will be treated per <G30>.

Since both *Craters* are *Alliance* neutral, *Inadvertent* and/or *Inconsequential* interaction between opposing *Alliance Robots* attempting to enter the *Craters* should not be considered illegal *Interference*. *Robot* actions that run an unnecessary risk of preventing opposing *Robot* access to the *Crater* is likely to be seen as illegal *Interference*. *Teams* should take this into consideration when designing their autonomous program.

**<GS3> Control/Possession Limits of Minerals** – A *Robot* may *Control* or *Possess* a maximum of *two (2)* *Minerals* at a time. However, due to the density of *Minerals* within the *Crater*, *Robots* may temporarily exceed this limit while collecting *Minerals* that are *In* the *Crater*. *Robots* are required to shed excess *Minerals* before performing any other gameplay activities. Within the *Crater*, plowing through any quantity of *Minerals* is allowed but herding or directing multiple *Minerals* beyond the allotted maximum to gain a strategic advantage (i.e., *Scoring*, accessibility, defense) is not allowed. The *Penalty* for *Controlling* or *Possessing* more than the allotted maximum is an immediate *Minor Penalty* for each *Mineral* above the limit plus an additional *Minor Penalty* per *Mineral* for each 5-second interval that this situation continues. A *Major Penalty* will be assessed

*Robot* designs that obscure visibility of *Minerals* within a *Robot* may prevent referees from providing feedback to *Drive Teams* about violations of <GS3> and may lead to the *Robot* earning *Penalties*.

for each *Mineral Scored* while a *Robot Controls* or *Possesses* more than the allotted maximum. Continued violation of this rule will escalate to *Yellow Cards* quickly.

**<GS4> De-scoring Minerals** – *Robots* may not remove or re-position *Minerals* from the *Cargo Holds*. *Robots* may remove *Minerals* from their opposing *Alliance's Depot* if it was not *Completely Claimed* in the *Autonomous Period*. *Robots* may remove *Minerals* from their own *Alliance's Depot*. A *Minor Penalty* will be assessed for each *Mineral* illegally removed or re-positioned.

**<GS5> Blocking Access to Scoring in the Lander** - *Robots* may not *Block* access to an opposing *Alliance's Lander Cargo Hold* or *Lander Support Bracket*. The first instance will result in an immediate *Major Penalty* and an additional *Minor Penalty* assessed for every five-seconds that the rule violation persists. If the referee declares a *Blocking access Penalty*, the offending *Robot* must move away at least 3 ft. (0.9 m), approximately 1.5 floor *Tiles* from the opponent's *Landing Zone*. Additional occurrences of violations of this rule will escalate to *Yellow Cards* quickly.

**<GS6> Interfering with Scoring at the Lander** – *Robots* may not *Interfere* with the opposing *Alliance's Robot* while that *Robot* is *In* their *Alliance's Landing Zone* attempting to *Score Minerals* or *Latch* to the *Lander*. *Interference* results in an immediate *Major Penalty* and an additional *Minor Penalty* assessed for every five-seconds that the rule violation persists. The intent of this rule is to allow *Robots* to *Score Minerals* or *Latch* without *Interference*. Additional occurrences of violations of this rule will escalate to *Yellow Cards* quickly.

**<GS7> Latching before the End Game** - *Deployed Robots* are not allowed to intentionally *Support* any portion of their weight with the *Lander Support Bracket* prior to the start of the *End Game*. *Robots* that attempt to *Latch* to the *Lander Support Bracket* before the start of the *End Game* are not eligible to *Score* the *End Game Latching* achievement.

**<GS8> Latching to the Lander** - *Robots* may latch only onto either of their *Alliance specific Lander Support Brackets*. A *Major Penalty* is assessed for violating this rule.

**<GS9> Launching Game Elements** - *Robots In* the *Landing Zone* for their corresponding *Alliance* may *Launch Game Elements* in an attempt to *Score* in a *Cargo Hold*. *Robots Outside* their *Alliance's Landing Zone* may not *Launch Game Elements*. A *Minor Penalty* is assessed for each illegally *Launched Game Element*. Additional occurrences of violations of this rule will escalate to *Yellow Cards* quickly.

Illegally *Launched Scoring Elements* are eligible to be counted as *Scored* and a *Minor Penalty* is assessed for each illegally *Launched Game Element*.

**<GS10> Robot Scoring while In Crater** - *Robots In* a *Crater* are not eligible to *Score Minerals*. Violations of this rule will result in a *Minor Penalty* per offense. Additional occurrences of violations of this rule will escalate to *Yellow Cards* quickly.

**<GS11> Obstructing Travel Between Lander and Crater** – *Robots* may not obstruct another *Robot's* path of travel in the area between the *Lander* and a *Crater* for more than 5 seconds. If a referee determines this rule is violated, the offending *Alliance* will receive a *Minor Penalty* for every five seconds that they are in violation of this rule. This rule only applies during the *Driver-Controlled Period*.

The intent of this Rule is that *Drive Teams* begin to immediately move their *Robots* away and have a five second grace period to move the required distance, and not that they are permitted to intentionally *Block* for up to five seconds.

## 1.7 Scoring Summary

The following table shows the possible *Scoring* achievements and their point values. The table is a quick reference guide and not a substitute for a thorough understanding of the game manual.

Scoring Achievement	Autonomous Points	Driver-Controlled Points	End Game Points**	Reference
<i>Robot</i>				
- Landing	30	-	-	1.5.2 - 1
- Claiming	15	-	-	1.5.2 - 2
- Parking	10	-	-	1.5.2 - 3
- Sampling	25	-	-	1.5.2 - 4
- Latching	-	-	50	1.5.4 - 1
- Robot In Crater	-	-	15	1.5.4 - 2
- Robot Completely In Crater	-	-	25	1.5.4 - 3
<i>Mineral</i>				
- Any Mineral in Depot	2	2	2	1.5.3 - 1
- Gold in Gold Cargo Hold	5	5	5	1.5.3 - 2
- Silver in Silver Cargo Hold	5	5	5	1.5.3 - 3
- Gold in Silver Cargo Hold	0	0	0	1.5.3 - 4
- Silver in Gold Cargo Hold	0	0	0	1.5.3 - 4

\*\* - The *End Game* occurs during the last thirty-seconds of the *Driver-Controlled Period*.

## 1.8 Rule Summary

The following table shows the possible rule violations and their consequences. The table is a quick reference guide and not a substitute for a thorough understanding of the complete rule descriptions in section 1.6.

Rule #	Rule	Consequence	Warning Disable	Minor Penalty	Major Penalty	Card Issued
<b>Safety Rules</b>						
<S1>	Unsafe Robot.	Disable if unsafe operation is likely to persist. Optional <i>Yellow Card</i> .	D			YC*
	Damage to the <i>Playing Field</i> .	Warning escalating to <i>Disable</i> . Optional <i>Yellow Card</i> .	W D			YC*
<S2>	Contact <i>Outside</i> the <i>Playing Field</i> .	<i>Immediate Yellow Card</i> and Optional <i>Disable</i> unless allowed by rule.	D*			YC
<S3>	<i>Drive Team</i> missing safety gear.	Warning and if not resolved within 30 seconds, the offending member(s) of the <i>Drive Team</i> must leave the <i>Competition Area</i> and may not be replaced.	W+			
<b>General Rules</b>						
<G1>	<i>Drive Team</i> using disallowed electronic communication.	Warning followed by a <i>Minor Penalty</i> .	W	1x		



Rule #	Rule	Consequence	Warning Disable	Minor Penalty	Major Penalty	Card Issued
<G2>	Pre-Match Robot setup – Entering the <i>Playing Field</i> .	May lead to <i>Disqualification</i> from <i>Match</i> or <i>Tournament</i> .				DQ*
<G3>	Pre-Match Robot placement.	<i>Minor Penalty</i> if <i>Teams</i> delay start of <i>Match</i> .		1x		
<G4>	Robot starting volume.	Robot is <i>Disabled</i> , powered off, and removed from the <i>Playing Field</i> .	D			
<G5>	Robot setup alignment devices/Match Delay.	<i>Minor Penalty</i> for each offense.		1x		
<G6>	Drive Team member(s) leaving the <i>Alliance Station</i> .	Warning for the first instance with any following instances resulting in a <i>Minor Penalty</i> .	W	1x		
<G7>	Starting Game Play Early.	<i>Minor Penalty</i> with the option of a <i>Major Penalty</i> if the early start results in a competitive advantage for the offending <i>Alliance</i> .		1x	1x	
<G8>	Late Start of the <i>Autonomous Period</i> .	<i>Minor Penalty</i> with the option of a <i>Major Penalty</i> if the late start results in a competitive advantage for the offending <i>Alliance</i> .		1x	1x	
<G9>	Robot control during <i>Autonomous Period</i> / Early stopping of <i>Autonomous</i> code.	<i>Major Penalty</i> for each offense.			1x	
<G10>	Stopping Game Play Late.	<i>Minor Penalty</i> and the actions of the <i>Robot</i> that occur after the end of game play do not count towards their <i>Alliance's Score</i> . <i>Major Penalty</i> if the late stop results in a competitive advantage for the offending <i>Alliance</i> .		1x	1x	
<G11>	Drive Team contact with the <i>Playing Field</i> , <i>Game Element</i> , or <i>Robot</i> .	Warning for the first instance with any following instances resulting in a <i>Minor Penalty</i> . Optional <i>Yellow Card</i> if contact affects <i>Scoring</i> and/or game play. Contact for safety reasons will not result in a warning or <i>Penalty</i> .	W	1x		YC*
<G13>	Drive Team Coach Driver <i>Station Control</i> .	Warning for the first instance with any following instances resulting in a <i>Major Penalty</i> .	W		1x	
<G15>	Robots deliberately detaching parts.	<i>Minor Penalty</i> . <i>Major Penalty</i> and a <i>Yellow Card</i> if it affects gameplay.		1x	1x	YC
<G16>	Robots illegally grasping <i>Game Elements</i> .	Warning for the first instance with any following instances resulting in a <i>Major Penalty</i> .	W		1x	
<G17>	Destruction, damage, tipping, etc.	Deliberate or chronic violations of this rule will receive a <i>Major Penalty</i> and a <i>Yellow Card</i> .			1x	YC

Rule #	Rule	Consequence	Warning Disable	Minor Penalty	Major Penalty	Card Issued
<G18>	<i>Pinning, Trapping, or Blocking</i> for more than 5-seconds in the <i>Driver-Controlled Period</i> .	<i>Minor Penalty</i> for every five seconds the <i>Robot</i> violates this rule.		1x		
<G20>	Deliberately removing <i>Game Elements</i> from the <i>Playing Field</i> .	<i>Minor Penalty</i> per <i>Game Element</i> deliberately removed from the <i>Playing Field</i> .		1x		
<G21>	<i>Scoring Elements</i> in contact or <i>Controlled</i> with <i>Robots</i> of the corresponding <i>Alliance</i> .	Points are not earned for any <i>Scoring Elements</i> in contact with <i>Robots</i> of the corresponding <i>Alliance</i> .				
<G22>	Delay caused by removal of <i>Robots</i> from the <i>Playing Field</i> and <i>Game Elements</i> from <i>Robots</i> .	A <i>Minor Penalty</i> will be assessed.		1x		
<G28>	Egregious behavior.	<i>Major Penalty</i> plus a <i>Yellow</i> and/or <i>Red Card</i> . Possible <i>Match Disqualification</i> . Subsequent violations result in <i>Team Disqualification</i> for the tournament.			1x	YC RC
<G29>	Illegal Use of <i>Game Elements</i> to ease or amplify <i>Scoring</i> .	<i>Major Penalty</i> will be assessed with any following instances resulting in a <i>Yellow Card</i> .			1x	YC
<b>Game-Specific Rules</b>						
<GS1>	Touching <i>Robots</i> or <i>Driver Stations</i> after <i>Sample Randomization</i> .	<i>Minor Penalty</i> and <i>Robot</i> is not eligible to earn the <i>Sample Score</i> .		1x+		
<GS2>	<i>Interference</i> with opposing <i>Alliance Scoring</i> or <i>Sample Field</i> during <i>Autonomous</i> .	<i>Major Penalty</i> will be assessed.			1x	
<GS3>	<i>Control / Possession</i> limits of <i>Minerals</i> .	<i>Minor Penalty</i> per <i>Mineral</i> plus an additional <i>Minor Penalty</i> per five seconds. <i>Major Penalty</i> if <i>Mineral</i> is <i>Scored</i> . May escalate to <i>Yellow Card</i> .		1x+	1x+	YC
<GS4>	<i>De-scoring Minerals</i> from <i>Cargo Holds</i> or <i>Completely Claimed Depots</i> .	<i>Minor Penalty</i> per <i>Mineral</i> .		1x+		
<GS5>	<i>Blocking</i> access to <i>Scoring</i> in <i>Lander</i> .	<i>Major Penalty</i> is assessed plus an additional <i>Minor Penalty</i> per 5 seconds in violation. May escalate to <i>Yellow Card</i> .		1x+	1x	YC*
<GS6>	<i>Interfering</i> with <i>Scoring</i> in <i>Lander</i> .	<i>Major Penalty</i> is assessed plus an additional <i>Minor Penalty</i> per 5 seconds in violation. May escalate to <i>Yellow Card</i> .		1x+	1x	YC*
<GS7>	<i>Latching</i> before <i>End Game</i> begins.	<i>Robot</i> ineligible to <i>Score</i> the <i>Latching</i> achievement.				

Rule #	Rule	Consequence	Warning Disable	Minor Penalty	Major Penalty	Card Issued
<GS8>	<i>Latching to opposing Alliance's Lander Support Bracket.</i>	<i>Major Penalty is assessed.</i>			1x	
<GS9>	<i>Launching Game Elements illegally.</i>	<i>Minor Penalty per occurrence. May escalate to Yellow Card.</i>		1x		YC*
<GS10>	<i>Illegally Scoring Minerals while In Crater</i>	<i>Minor Penalty per occurrence. May escalate to Yellow Card.</i>		1x		YC*
<GS11>	<i>Obstructing travel between the Lander and Crater</i>	<i>Minor Penalty per 5 seconds in violation.</i>		1x+		

Column Key
1x: <i>Penalty at normal (single) cost</i>
2x: <i>Penalty at double cost</i>
D: <i>Robot Disabled</i>
D*: <i>Robot optionally Disabled</i>
DQ*: <i>Possible Disqualification</i>
RC: <i>Red Card issued</i>
W: <i>Warning</i>
YC: <i>Yellow Card issued</i>
YC*: <i>Yellow Card optionally issued</i>

## Appendix A – Resources

---

### Game Forum Q&A

<http://ftcforum.usfirst.org/forum.php>

Anyone may view questions and answers within the *FIRST*® Tech Challenge Game Q&A forum without a password. To submit a new question, you must have a unique Q&A System User Name and Password for your team.

Volunteers that apply for a specific volunteer role will receive an email from [FTCTrainingSupport@firstinspires.org](mailto:FTCTrainingSupport@firstinspires.org) with their username and password to the forum. You will receive access to the forum thread specific to your role.

### FIRST Tech Challenge Game Manuals

Part 1 and 2 - <https://www.firstinspires.org/resource-library/ftc/game-and-season-info>

### FIRST Headquarters Pre-Event Support

Phone: 603-666-3906

Mon – Fri

8:30am – 5:00pm Eastern Time

Email: [firsttechchallengeteams@firstinspires.org](mailto:firsttechchallengeteams@firstinspires.org)

### FIRST Websites

*FIRST* homepage – [www.firstinspires.org](http://www.firstinspires.org)

[FIRST Tech Challenge Page](#) – For everything *FIRST* Tech Challenge.

[FIRST Tech Challenge Volunteer Resources](#) – To access public Volunteer Manuals.

[FIRST Tech Challenge Event Schedule](#) – Find *FIRST* Tech Challenge events in your area.

### FIRST Tech Challenge Social Media

[FIRST Tech Challenge Twitter Feed](#) - If you are on Twitter, follow the *FIRST* Tech Challenge Twitter feed for news updates.

[FIRST Tech Challenge Facebook page](#) - If you are on Facebook, follow the *FIRST* Tech Challenge page for news updates.

[FIRST Tech Challenge YouTube Channel](#) – Contains training videos, Game animations, news clips, and more.

[FIRST Tech Challenge Blog](#) – Weekly articles for the *FIRST* Tech Challenge community, including Outstanding Volunteer Recognition!

[FIRST Tech Challenge Team Email Blasts](#) – contain the most recent *FIRST* Tech Challenge news for Teams.

### Feedback

We strive to create support materials that are the best they can be. If you have feedback about this manual, please email [firsttechchallengeteams@firstinspires.org](mailto:firsttechchallengeteams@firstinspires.org). Thank you!

## Appendix B - Field Details

### Sample Field

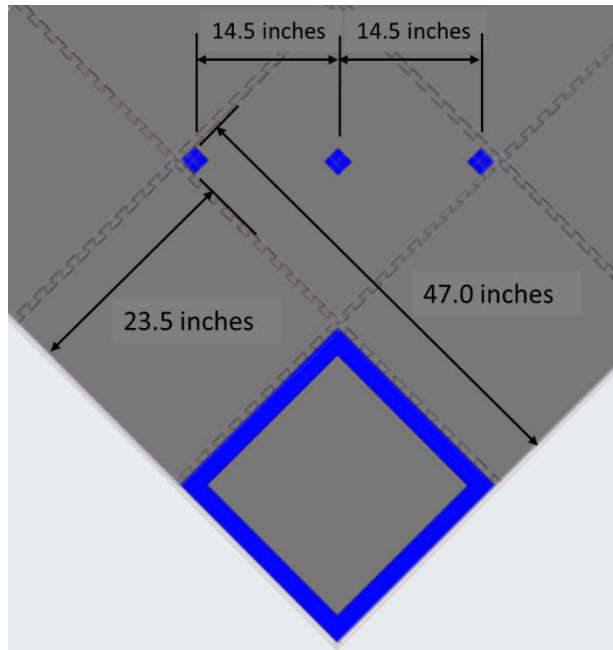

Figure B-1 Sample Field Locations

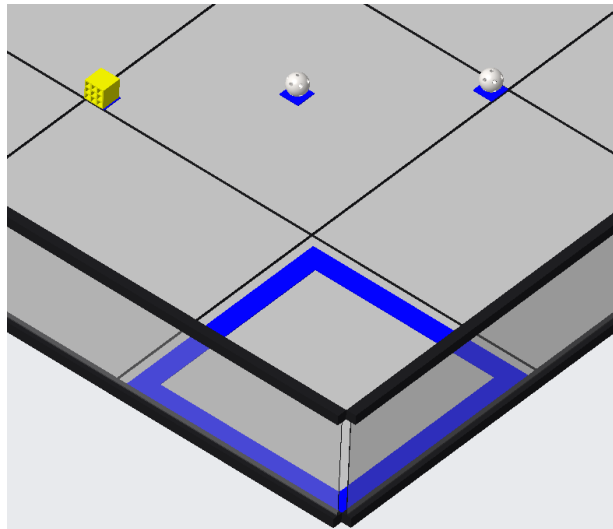

Figure B-2 Example of Samples positioned on Sample Field

The type of *Minerals* positioned at the three locations in the *Sample Field* will be randomized prior to each *Match*. There will always be one (1) *Gold* and two (2) *Silver Minerals*. The starting locations for the *Samples* are 2" x 2" strips of red or blue Gaffer tape located as shown in Figure B1-1. The two outside tape strips are positioned in the corners of the *Tile*, adjacent to the inside edge of the *Tile* tabs. The third tape strip is located midway between the two outside strips.

## Lander

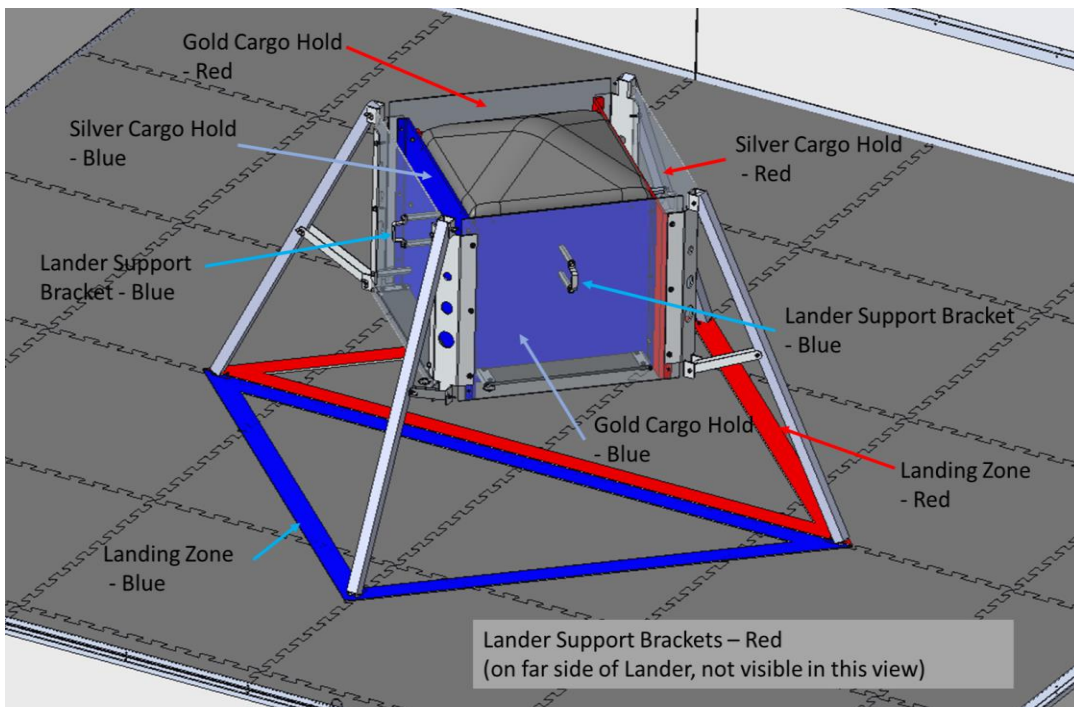

Figure B-3 Lander Detail

## Lander Support Bracket

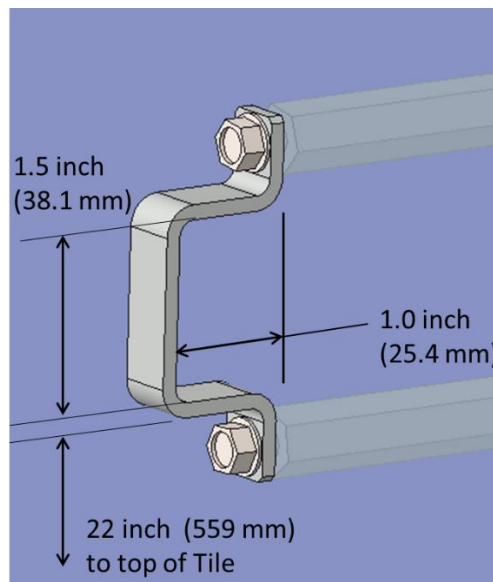

Figure B-4 Lander Support Bracket Detail

## Navigation Target

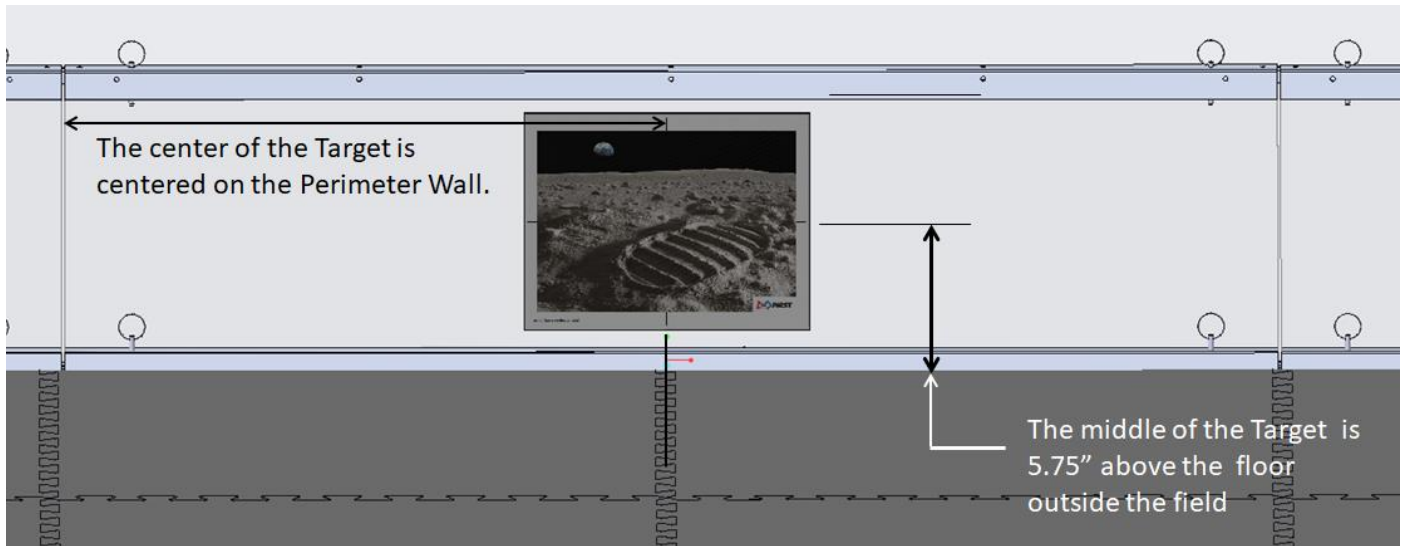

Figure B-5 Navigation Target Location

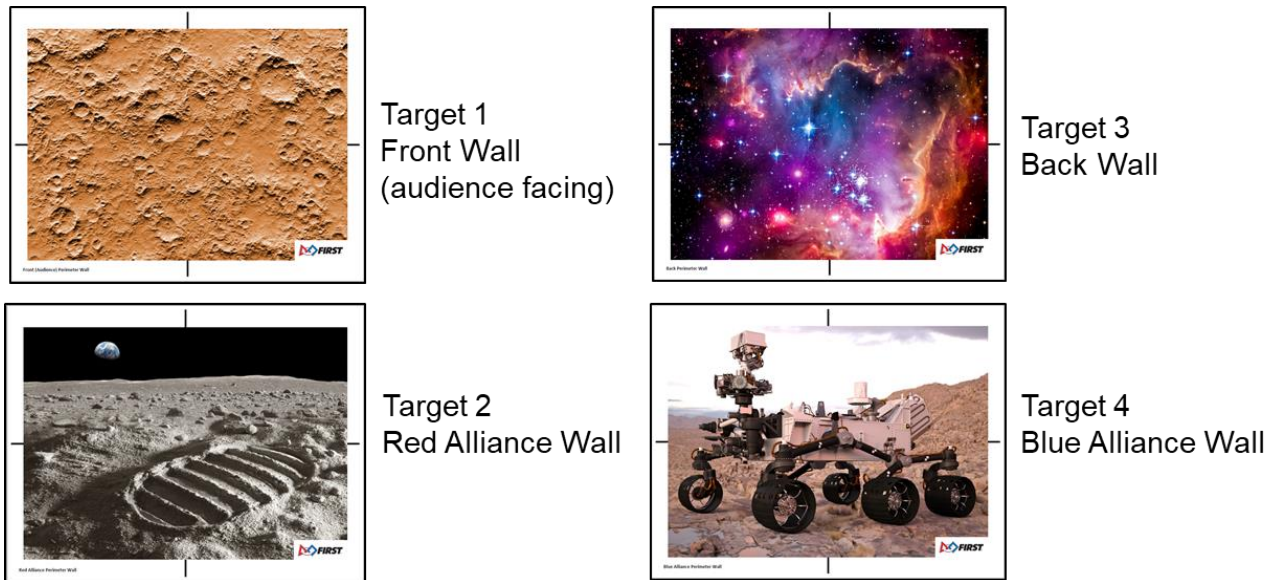
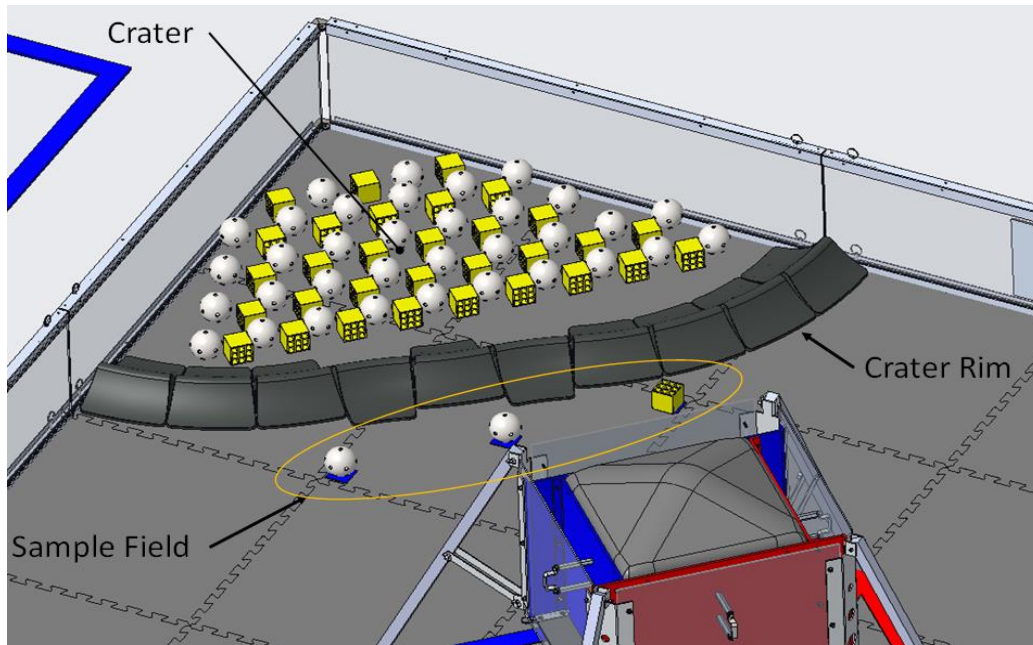

Figure B-6 Navigation Targets

### Crater



**Figure B-7 Silver and Gold Minerals will be randomly mixed. Each Crater will contain approximately half the available Minerals.**

### Landing Zone

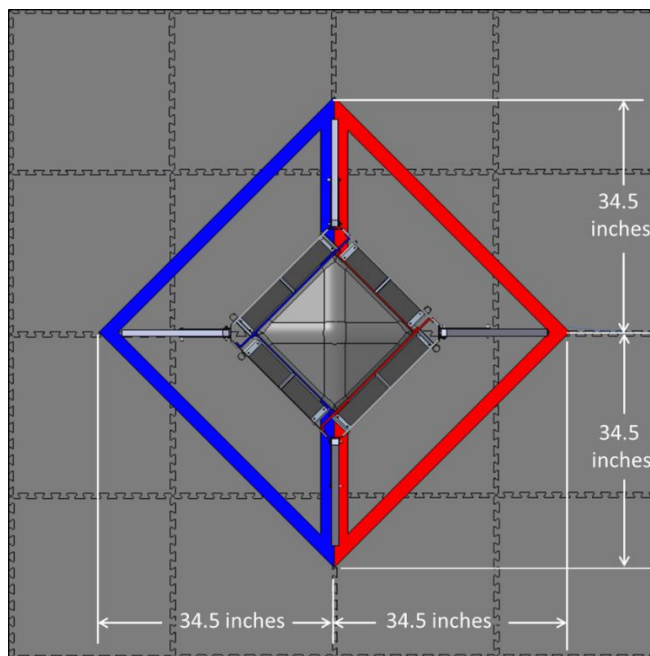

**Figure B-8 Landing Zone Dimensions**



## Appendix C – Game Elements

### Minerals

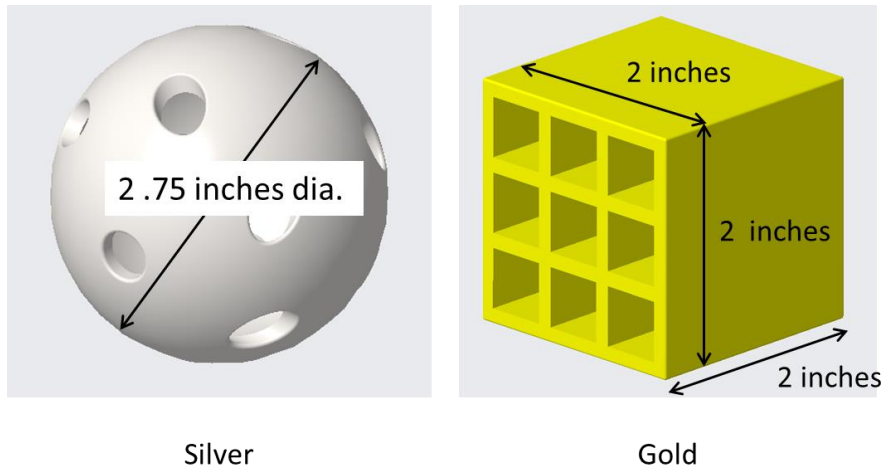

Figure C-1 There are sixty (60) Silver and ninety (90) Gold Minerals on the Playing Field.

### Team Markers

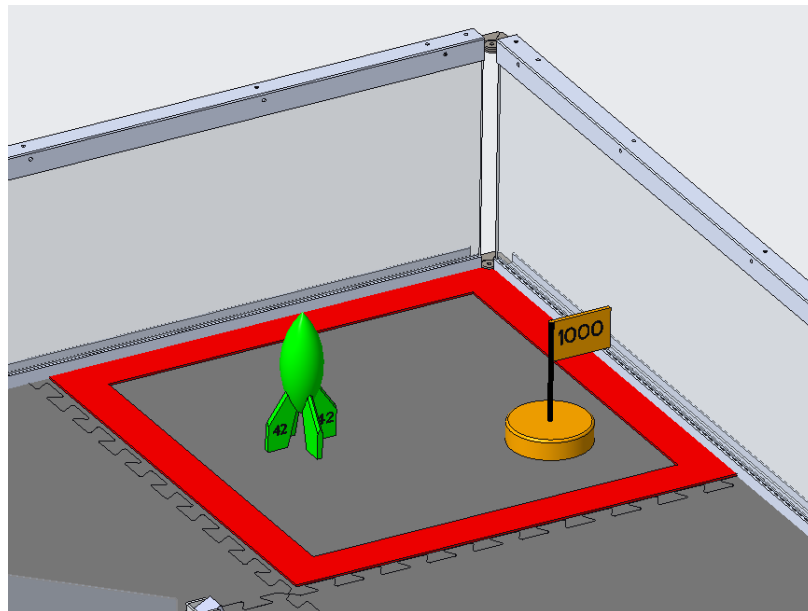
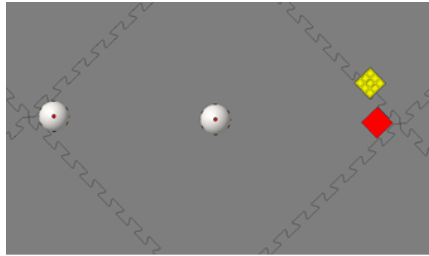
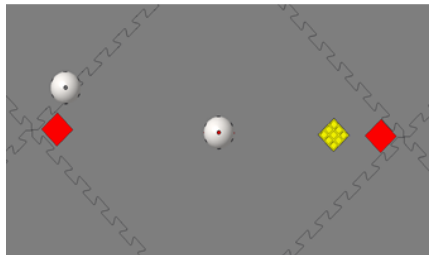

Figure C-2 A Team Marker is supplied by the Team and is constrained by the rules in section 8.4 in the Game Manual Part 1.

## Appendix D – Sample Field



**Example 1:** Red earns the *Sampling* points.  
 The *Gold Sample* has been moved *Completely Off* the starting location and the *Silver Samples* are still *In* their starting locations.



**Example 2:** Red does not earn the *Sampling* points.  
 The *Gold Sample* has been moved *Completely Off* the starting location but one of the *Silver Samples* is *Outside* of it's starting location.

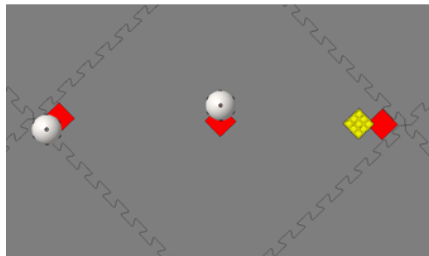

**Example 3:** Red does not earn the *Sampling* points.  
 The *Gold Sample* has not been moved *Completely Off* the starting location.

**Figure D-1 Sample Field Scoring Examples**

*Note: The Gold Sample will always be placed such that the hole pattern is facing up.*

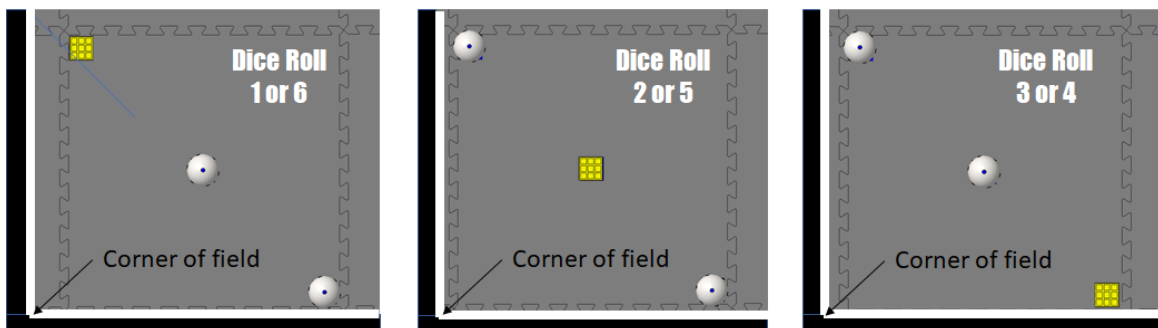

**Figure D-2 Sample Field Pattern determined by die roll**

## Appendix E – Cargo Hold Scoring

Per section 1.5.3 – 5, the *Cargo Hold* volume is defined by the 5 inner surfaces of the *Cargo Hold* and the horizontal extension of the upper edge of the clear panel on the outside of the *Cargo Hold*.

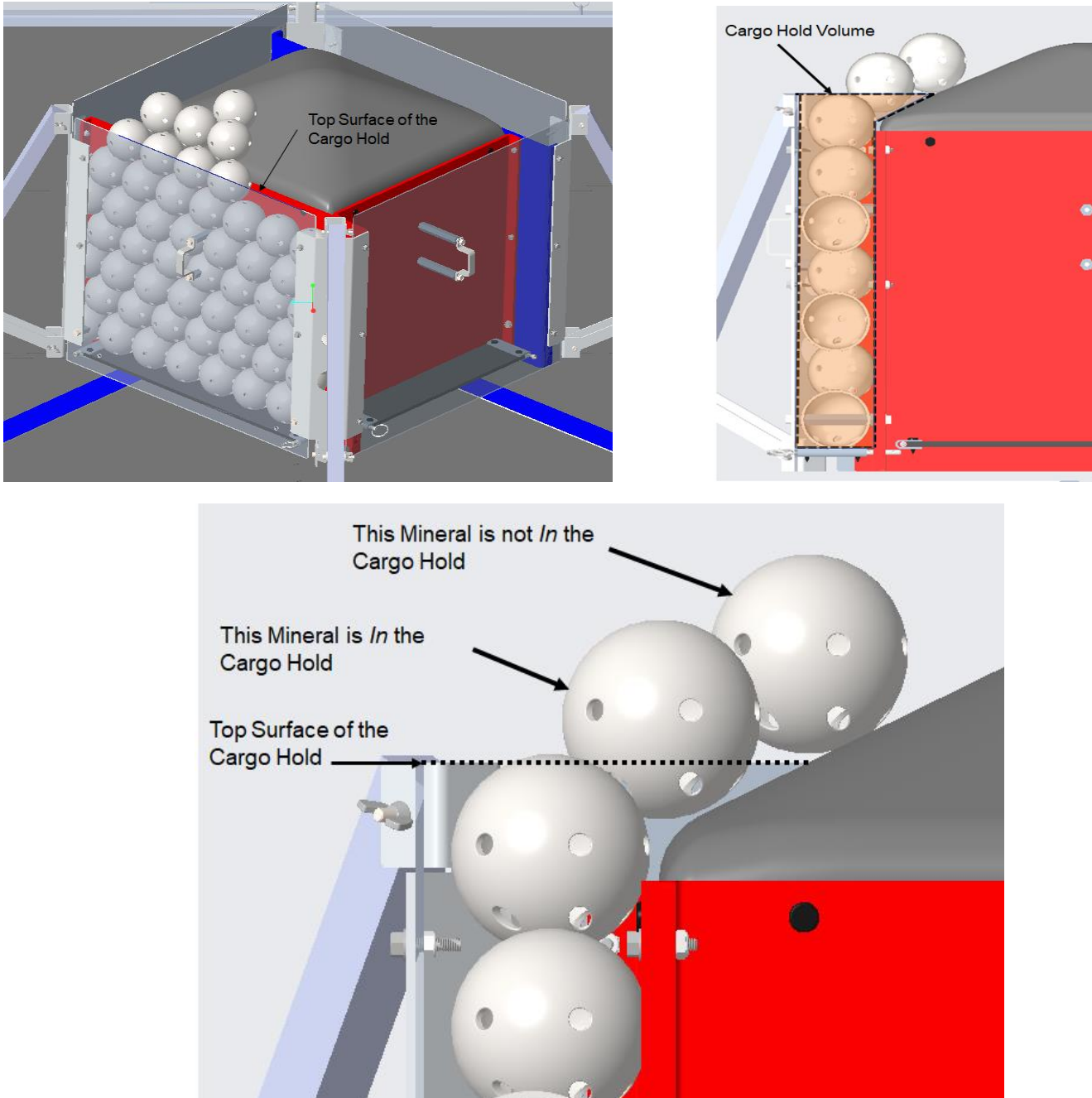

Figure E-1 Cargo Hold Scoring