

LOCKHEED MARTIN ENERGY RESEARCH LIBRARIES



3 4456 0515112 6

ORNL-5018

Cy 2

Program Plan for Development of Molten-Salt Breeder Reactors

OAK RIDGE NATIONAL LABORATORY
CENTRAL RESEARCH LIBRARY
DOCUMENT COLLECTION

LIBRARY LOAN COPY

DO NOT TRANSFER TO ANOTHER PERSON

If you wish someone else to see this
document, send in name with document
and the library will arrange a loan.

UCN-7969
(3 3-67)



OAK RIDGE NATIONAL LABORATORY

OPERATED BY UNION CARBIDE CORPORATION • FOR THE U.S. ATOMIC ENERGY COMMISSION

Printed in the United States of America. Available from
National Technical Information Service
U.S. Department of Commerce
5285 Port Royal Road, Springfield, Virginia 22161
Price: Printed Copy \$13.60; Microfiche \$2.25

This report was prepared as an account of work sponsored by the United States Government. Neither the United States nor the United States Atomic Energy Commission, nor any of their employees, nor any of their contractors, subcontractors, or their employees, makes any warranty, express or implied, or assumes any legal liability or responsibility for the accuracy, completeness or usefulness of any information, apparatus, product or process disclosed, or represents that its use would not infringe privately owned rights.

ORNL-5018
UC-76 - Molten Salt Reactor Technology

Contract No. W-7405-eng-26

PROGRAM PLAN
FOR
DEVELOPMENT OF MOLTEN-SALT BREEDER REACTORS

L. E. McNeese
and
Staff of the Molten-Salt Reactor Program

DECEMBER 1974

OAK RIDGE NATIONAL LABORATORY
Oak Ridge, Tennessee 37830
operated by
UNION CARBIDE CORPORATION
for the
U.S. ATOMIC ENERGY COMMISSION

LOOKHEED MARTIN ENERGY RESEARCH LIBRARIES



3 4456 0515112 6



CONTENTS

	<u>Page</u>
1. PROGRAM PLAN OVERVIEW	1-1
1.1 INTRODUCTION AND SUMMARY	1-1
1.2 STATUS OF TECHNOLOGY AND PLANNED DEVELOPMENT ACTIVITIES	1-2
1.2.1 Development of structural metal for primary and secondary circuits	1-2
1.2.2 Fuel processing	1-4
1.2.3 Fuel processing materials development	1-5
1.2.4 Chemical research and development	1-7
1.2.5 Analytical research and development	1-9
1.2.6 Reactor safety	1-10
1.2.7 Reactor design and analysis	1-11
1.2.8 Graphite development	1-13
1.2.9 Reactor technology development	1-14
1.2.10 Maintenance	1-15
1.2.11 Instrumentation and controls development	1-17
1.2.12 Molten-Salt Test Reactor mockup	1-17
1.2.13 Molten-Salt Test Reactor	1-18
1.2.14 Molten-Salt Demonstration Reactor	1-19
1.3 KEY PROGRAM MILESTONES	1-19
1.4 ESTIMATED FUND REQUIREMENTS	1-19
REFERENCES FOR SECTION 1	1-28
2. DEVELOPMENT OF STRUCTURAL METAL FOR PRIMARY AND SECONDARY CIRCUITS	2-1
2.1 INTRODUCTION	2-1
2.1.1 Objective	2-1
2.1.2 Scope	2-1
2.2 PROGRAM BUDGET AND SCHEDULE	2-3
2.2.1 Schedule and key program milestones	2-3
2.2.2 Funding	2-3
2.3 MATERIAL REQUIREMENTS, BACKGROUND, AND STATUS OF DEVELOPMENT	2-3
2.3.1 Material requirements	2-3
2.3.2 Background	2-8
2.3.3 Status of development	2-13
2.4 TASK GROUP 1.1 DETERMINATION OF ALLOY COMPOSITION	2-19
2.4.1 Objective	2-19
2.4.2 Schedule	2-19
2.4.3 Funding	2-23
2.4.4 Facilities	2-23
2.4.5 Task 1.1.1 Procurement of test materials	2-23
2.4.6 Task 1.1.2 Basic studies on interaction of tellurium with Hastelloy N	2-26
2.4.7 Task 1.1.3 Effects of fission products on mechanical properties	2-27
2.4.8 Task 1.1.4 Thermal convection corrosion tests	2-28

	<u>Page</u>
2.4.9 Task 1.1.5 Forced convection corrosion tests . . .	2-29
2.4.10 Task 1.1.6 In-reactor fueled capsule tests	2-30
2.4.11 Task 1.1.7 Irradiation embrittlement of Hastelloy N	2-31
2.5 TASK GROUP 1.2 PROCUREMENT OF COMMERCIAL HEATS	2-33
2.5.1 Objective	2-34
2.5.2 Schedule	2-34
2.5.3 Funding	2-34
2.5.4 Task 1.2.1 Specifications	2-34
2.5.5 Task 1.2.2 Bidding and vendor selection	2-34
2.5.6 Task 1.2.3 Surveillance of fabrication	2-34
2.5.7 Task 1.2.4 Receipt and cataloging of material	2-34
2.6 TASK GROUP 1.3 EVALUATION OF COMMERCIAL HEATS	2-36
2.6.1 Objective	2-36
2.6.2 Schedule	2-36
2.6.3 Funding	2-36
2.6.4 Facilities	2-36
2.6.5 Task 1.3.1 Weldability	2-36
2.6.6 Task 1.3.2 Mechanical property tests	2-40
2.6.7 Task 1.3.3 Physical property measurements	2-41
2.6.8 Task 1.3.4 Thermal convection corrosion tests	2-42
2.6.9 Task 1.3.5 Forced convection corrosion tests	2-42
2.6.10 Task 1.3.6 In-reactor fueled capsule tests	2-43
2.7 TASK GROUP 1.4 DEVELOPMENT OF ANALYTICAL DESIGN METHODS — ASME CODE CASE SUBMISSION	2-44
2.7.1 Objective	2-44
2.7.2 Schedule	2-44
2.7.3 Funding	2-44
2.7.4 Facilities	2-44
2.7.5 Task 1.4.1 Data analysis	2-44
2.7.6 Task 1.4.2 Development of design methods	2-46
2.7.7 Task 1.4.3 Submission of code case	2-46
2.8 TASK GROUP 1.5 LONG-TERM MATERIALS TEST	2-46
2.8.1 Objective	2-47
2.8.2 Schedule	2-47
2.8.3 Funding	2-47
2.8.4 Facilities	2-47
2.8.5 Task 1.5.1 Mechanical property tests	2-47
2.8.6 Task 1.5.2 Forced circulation loops	2-47
2.8.7 Task 1.5.3 In-reactor fueled capsule tests	2-49
2.9 TASK GROUP 1.6 MATERIAL OPTIMIZATION	2-49
2.9.1 Objective	2-49
2.9.2 Schedule	2-49
2.9.3 Funding	2-50
2.9.4 Facilities	2-50
2.9.5 Task 1.6.1 Further Hastelloy N improvement	2-50
2.9.6 Task 1.6.2 Consideration of other materials	2-50
REFERENCES FOR SECTION 2	2-52

	<u>Page</u>
3. FUEL PROCESSING	3-1
3.1 INTRODUCTION	3-1
3.1.1 Objective	3-1
3.1.2 Scope	3-1
3.2 PROGRAM BUDGET AND SCHEDULE	3-3
3.2.1 Schedule and key program milestones	3-3
3.2.2 Budget	3-3
3.3 REQUIREMENTS, BACKGROUND, AND STATUS OF DEVELOPMENT	3-8
3.3.1 Processing requirements	3-8
3.3.2 Background	3-8
3.3.3 Status of development	3-15
3.4 TASK GROUP 2.1 FLOWSHEET ANALYSIS AND DEVELOPMENT	3-20
3.4.1 Objective	3-20
3.4.2 Schedule	3-20
3.4.3 Funding	3-20
3.4.4 Task 2.1.1 Heat balances	3-23
3.4.5 Task 2.1.2 Mass balances	3-23
3.4.6 Task 2.1.3 Parametric and optimization studies	3-23
3.4.7 Task 2.1.4 Waste characterization	3-23
3.4.8 Task 2.1.5 Processing plant conceptual design and cost estimate	3-24
3.4.9 Task 2.1.6 Processing system control	3-24
3.4.10 Task 2.1.7 Resource requirements and utilization	3-24
3.4.11 Task 2.1.8 Alternate process development	3-25
3.5 TASK GROUP 2.2 CONTINUOUS FLUORINATOR DEVELOPMENT	3-25
3.5.1 Objective	3-25
3.5.2 Schedule	3-25
3.5.3 Funding	3-27
3.5.4 Facilities	3-27
3.5.5 Task 2.2.1 Nonradioactive heat generation studies	3-27
3.5.6 Task 2.2.2 Fluorination chemistry	3-30
3.5.7 Task 2.2.3 Frozen wall corrosion protection studies	3-30
3.5.8 Task 2.2.4 Mass transfer in open bubble columns	3-31
3.5.9 Task 2.2.5 Characterization of the F ₂ -H ₂ reaction	3-31
3.5.10 Task 2.2.6 Continuous Fluorinator Experimental Facility	3-31
3.5.11 Task 2.2.7 Fluorination-Reconstitution Engineering Facility	3-33
3.6 TASK GROUP 2.3 FUEL RECONSTITUTION	3-34
3.6.1 Objective	3-34
3.6.2 Schedule	3-34
3.6.3 Funding	3-34
3.6.4 Facilities	3-37
3.6.5 Task 2.3.1 Fuel reconstitution chemistry	3-37

	<u>Page</u>
3.6.6 Task 2.3.2 Engineering studies of fuel reconstitution	3-38
3.6.7 Task 2.3.3 Fluorination-Reconstitution Engineering Facility	3-38
3.7 TASK GROUP 2.4 PROTACTINIUM REMOVAL	3-40
3.7.1 Objective	3-40
3.7.2 Schedule	3-40
3.7.3 Funding	3-42
3.7.4 Facilities	3-42
3.7.5 Task 2.4.1 Salt-metal contactor development	3-42
3.7.6 Task 2.4.2 Engineering studies of hydro-fluorination and hydrochlorination in salt-bismuth systems	3-45
3.7.7 Task 2.4.3 Reductive Extraction Process Facility	3-45
3.7.8 Task 2.4.4 Protactinium Isolation Demonstration Experiment	3-47
3.8 TASK GROUP 2.5 RARE-EARTH REMOVAL	3-49
3.8.1 Objective	3-49
3.8.2 Schedule	3-49
3.8.3 Funding	3-49
3.8.4 Facilities	3-49
3.8.5 Task 2.5.1 Metal transfer experiment MTE-3B	3-52
3.8.6 Task 2.5.2 Salt-metal contactor development	3-52
3.8.7 Task 2.5.3 Metal Transfer Process Facility	3-52
3.9 TASK GROUP 2.6 FUEL SALT PURIFICATION	3-56
3.9.1 Objective	3-56
3.9.2 Schedule	3-56
3.9.3 Funding	3-56
3.9.4 Facilities	3-58
3.9.5 Task 2.6.1 Uranium valance adjustment	3-58
3.9.6 Task 2.6.2 Bismuth removal	3-58
3.10 TASK GROUP 2.7 ACTINIDE-FISSION PRODUCT SEPARATION AND ACTINIDE RECYCLE	3-58
3.10.1 Objective	3-58
3.10.2 Schedule	3-58
3.10.3 Funding	3-60
3.10.4 Facilities	3-60
3.10.5 Task 2.7.1 Chemistry of zirconium chlorides	3-60
3.10.6 Task 2.7.2 Flowsheet analysis	3-60
3.10.7 Task 2.7.3 Identification of required development	3-61
3.11 TASK GROUP 2.8 MSBR PROCESSING ENGINEERING LABORATORY DESIGN AND CONSTRUCTION	3-61
3.11.1 Objective	3-61
3.11.2 Schedule	3-62
3.11.3 Funding	3-62
3.11.4 Task 2.8.1 Conceptual design	3-62
3.11.5 Task 2.8.2 Title I design	3-65
3.11.6 Task 2.8.3 Title II design	3-65

	<u>Page</u>
3.11.7 Task 2.8.4 Construction	3-65
3.11.8 Task 2.8.5 Acceptance of facility	3-65
3.12 TASK GROUP 2.9 INTEGRATED PROCESS TEST FACILITY	3-65
3.12.1 Objective	3-65
3.12.2 Schedule	3-66
3.12.3 Funding	3-66
3.12.4 Facilities	3-66
3.12.5 Task 2.9.1 Definition of experimental program and preliminary design	3-66
3.12.6 Task 2.9.2 Development work required for design	3-70
3.12.7 Task 2.9.3 Conceptual design	3-70
3.12.8 Task 2.9.4 Title I design	3-70
3.12.9 Task 2.9.5 Title II design	3-70
3.12.10 Task 2.9.6 Equipment fabrication	3-70
3.12.11 Task 2.9.7 Equipment installation	3-70
3.12.12 Task 2.9.8 Initial testing and operator training	3-71
3.12.13 Task 2.9.9 Operation	3-71
REFERENCES FOR SECTION 3	3-72
4. FUEL-PROCESSING MATERIALS DEVELOPMENT	4-1
4.1 INTRODUCTION	4-1
4.1.1 Objective	4-1
4.1.2 Scope	4-1
4.2 PROGRAM BUDGET AND SCHEDULE	4-2
4.2.1 Schedule and key program milestones	4-2
4.2.2 Funding	4-2
4.3 MATERIAL REQUIREMENTS, BACKGROUND, AND STATUS OF DEVELOPMENT	4-2
4.3.1 Materials requirements	4-2
4.3.2 Background	4-3
4.3.3 Status of development	4-8
4.3.4 Basis for materials selection	4-11
4.4 TASK GROUP 3.1 DETERMINATION OF CORROSION-RESISTANT MATERIALS	4-11
4.4.1 Objective	4-11
4.4.2 Schedule	4-12
4.4.3 Funding	4-12
4.4.4 Facilities	4-12
4.4.5 Task 3.1.1 Compatibility of molybdenum with molten salts and Bi-Li-Th solutions	4-12
4.4.6 Task 3.1.2 Compatibility of graphite with Bi-Li-Th solutions	4-18
4.4.7 Task 3.1.3 Compatibility of tantalum and tantalum alloys with molten salts and Bi-Li solutions	4-20
4.4.8 Task 3.1.4 Compatibility of braze alloys with molten salts and Bi-Li-Th solutions	4-21

	<u>Page</u>
4.5 TASK GROUP 3.2 DEVELOPMENT OF FABRICATION AND JOINING TECHNIQUES	4-22
4.5.1 Objective	4-22
4.5.2 Schedule	4-22
4.5.3 Funding	4-22
4.5.4 Facilities	4-22
4.5.5 Task 3.2.1 Fabrication development of molybdenum and molybdenum alloys	4-29
4.5.6 Task 3.2.2 Fabrication development of tantalum and tantalum alloys	4-30
4.5.7 Task 3.2.3 Fabrication development of graphite	4-31
4.5.8 Task 3.2.4 Joining of molybdenum and molybdenum alloys	4-32
4.5.9 Task 3.2.5 Joining of tantalum alloys	4-33
4.5.10 Task 3.2.6 Joining of graphite	4-34
4.6 TASK GROUP 3.3 CONSTRUCTION OF ENGINEERING FUEL PROCESSING EXPERIMENTS	4-36
4.6.1 Objective	4-36
4.6.2 Schedule	4-36
4.6.3 Funding	4-36
4.6.4 Facilities	4-36
4.6.5 Task 3.3.1 Continuous Fluorinator Experimental Facility	4-36
4.6.6 Task 3.3.2 Fluorination-Reconstitution Engineering Facility	4-39
4.6.7 Task 3.3.3 Reduction Extraction Process Facility	4-39
4.6.8 Task 3.3.4 Metal Transfer Process Facility	4-40
4.6.9 Task 3.3.5 Integrated Process Test Facility	4-41
REFERENCES FOR SECTION 4	4-42
5. CHEMICAL RESEARCH AND DEVELOPMENT	5-1
5.1 INTRODUCTION	5-1
5.1.1 Objective	5-1
5.1.2 Scope	5-1
5.2 PROGRAM BUDGET AND SCHEDULE	5-2
5.2.1 Schedule and key program milestones	5-2
5.2.2 Budget summary	5-2
5.3 REQUIREMENTS, BACKGROUND AND STATUS OF DEVELOPMENT	5-2
5.3.1 Requirements	5-2
5.3.2 Background	5-7
5.3.3 Status of development	5-8
5.4 TASK GROUP 4.1 FUEL SALT CHEMISTRY	5-17
5.4.1 Objective	5-17
5.4.2 Schedule	5-18
5.4.3 Funding	5-18
5.4.4 Facilities	5-18
5.4.5 Task 4.1.1 Solubility products of actinide oxides	5-18

	<u>Page</u>
5.4.6 Task 4.1.2 Tellurium chemistry	5-27
5.4.7 Task 4.1.3 Phase behavior of PuF ₃ in fuel salt	5-30
5.4.8 Task 4.1.4 Fuel-coolant interaction studies	5-30
5.4.9 Task 4.1.5 Physical property determinations on fuel salt	5-34
5.4.10 Task 4.1.6 U ³⁺ /U ⁴⁺ equilibria studies	5-35
5.5 TASK GROUP 4.2 COOLANT SALT CHEMISTRY	5-37
5.5.1 Objective	5-37
5.5.2 Schedule	5-37
5.5.3 Funding	5-37
5.5.4 Facilities	5-37
5.5.5 Task 4.2.1 Oxide and hydroxide chemistry of fluoroborate	5-37
5.5.6 Task 4.2.2 Corrosion chemistry of fluoroborate	5-44
5.5.7 Task 4.2.3 Coolant purification	5-46
5.5.8 Task 4.2.4 Alternate coolant evaluation	5-47
5.5.9 Task 4.2.5 Physical property determinations on coolants	5-48
5.6 TASK GROUP 4.3 TRITIUM BEHAVIOR	5-49
5.6.1 Objective	5-49
5.6.2 Schedule	5-49
5.6.3 Funding	5-49
5.6.4 Facilities	5-49
5.6.5 Task 4.3.1 Permeation studies	5-56
5.6.6 Task 4.3.2 Solubility of tritium-containing species in molten salts	5-57
5.6.7 Task 4.3.3 Equilibria between important species containing tritium in salt-gas systems	5-58
5.6.8 Task 4.3.4 Isotopic exchange between tritium and chemically bound hydrogen	5-59
5.6.9 Task 4.3.5 TF corrosion behavior at low TF activity	5-59
5.6.10 Task 4.3.6 Diffusivity studies	5-59
5.6.11 Task 4.3.7 Modeling of tritium behavior in molten-salt reactors	5-60
5.6.12 Task 4.3.8 Tritium adsorption on carbon in contact with the coolant	5-60
5.7 TASK GROUP 4.4 FISSION PRODUCT CHEMISTRY	5-61
5.7.1 Objective	5-61
5.7.2 Schedule	5-61
5.7.3 Funding	5-61
5.7.4 Facilities	5-61
5.7.5 Task 4.4.1 Noble metal chemistry	5-61
5.7.6 Task 4.4.2 Iodine distribution	5-68
5.7.7 Task 4.4.3 Decontamination of Hastelloy N	5-68
5.7.8 Task 4.4.4 Analysis of fission product deposition data from MSRE	5-69
5.7.9 Task 4.4.5 Studies in the Gas-System Technology Facility (GSTF)	5-69

	<u>Page</u>
5.8 TASK GROUP 4.5 FUNDAMENTAL STUDIES OF MOLTEN SALTS . . .	5-70
5.8.1 Objective	5-70
5.8.2 Schedule	5-70
5.8.3 Funding	5-70
5.8.4 Facilities	5-70
5.8.5 Task 4.5.1 Formation-free energy and activity coefficient determination	5-72
5.8.6 Task 4.5.2 Porous electrode studies	5-73
REFERENCES FOR SECTION 5	5-74
6. ANALYTICAL RESEARCH AND DEVELOPMENT	6-1
6.1 INTRODUCTION	6-1
6.1.1 Objective	6-1
6.1.2 Scope	6-2
6.2 PROGRAM BUDGET AND SCHEDULE	6-2
6.2.1 Schedule and key program milestones	6-2
6.2.2 Budget	6-2
6.3 REQUIREMENTS, EXPERIENCE, AND STATUS OF DEVELOPMENT	6-2
6.3.1 Requirements	6-2
6.3.2 Experience	6-8
6.3.3 Status of development	6-11
6.4 TASK GROUP 5.1 IN-LINE ELECTROCHEMICAL METHODS	6-16
6.4.1 Objective	6-16
6.4.2 Schedule	6-16
6.4.3 Funding	6-16
6.4.4 Facilities	6-16
6.4.5 Task 5.1.1 Fuel salt analysis	6-22
6.4.6 Task 5.1.2 LiCl analyses	6-32
6.4.7 Task 5.1.3 Coolant salt analysis	6-36
6.4.8 Task 5.1.4 Effects of radiation on electroanalytical transducers	6-40
6.5 TASK GROUP 5.2 APPLICATION OF SPECTROPHOTO- METRIC METHODS	6-42
6.5.1 Objective	6-42
6.5.2 Schedule	6-42
6.5.3 Funding	6-42
6.5.4 Facilities	6-47
6.5.5 Task 5.2.1 Fuel salt analysis	6-47
6.5.6 Task 5.2.2 LiCl analysis	6-54
6.5.7 Task 5.2.3 Coolant salt analysis	6-56
6.5.8 Task 5.2.4 Effects of radiation on optical components and spectra	6-59
6.6 TASK GROUP 5.3 ANALYSIS BY CHEMICAL METHODS	6-60
6.6.1 Objective	6-60
6.6.2 Schedule	6-60
6.6.3 Funding	6-60
6.6.4 Facilities	6-60
6.6.5 Task 5.3.1 Analysis of discrete samples	6-60
6.6.6 Task 5.3.2 In-line chemical methods	6-66
6.6.7 Task 5.3.3 Effects of radiation on chemical methods	6-70

	<u>Page</u>
6.7 TASK GROUP 5.4 ANALYSIS OF GAS STREAMS	6-71
6.7.1 Objective	6-71
6.7.2 Schedule	6-71
6.7.3 Funding	6-71
6.7.4 Facilities	6-71
6.7.5 Task 5.4.1 Analysis of fuel cover gas	6-75
6.7.6 Task 5.4.2 Analysis of gas streams from the processing system	6-76
6.7.7 Task 5.4.3 Analysis of coolant cover gas	6-78
6.7.8 Task 5.4.4 Effects of radiation on gas analysis equipment	6-80
6.8 TASK GROUP 5.5 MEASUREMENT OF FISSION PRODUCTS AND PROTACTINIUM BY GAMMA SPECTROMETRY	6-80
6.8.1 Objective	6-80
6.8.2 Schedule	6-80
6.8.3 Funding	6-80
6.8.4 Facilities	6-83
6.8.5 Task 5.5.1 Evaluation of method	6-83
6.8.6 Task 5.5.2 In-pile activation experiments	6-84
6.8.7 Task 5.5.3 Selection and design of equipment for reactors	6-84
6.9 TASK GROUP 5.6 IN-LINE ANALYTICAL TEST FACILITY	6-85
6.9.1 Objective	6-85
6.9.2 Schedule	6-85
6.9.3 Funding	6-85
6.9.4 Task 5.6.1 Conceptual design and definition of experimental program	6-85
6.9.5 Task 5.6.2 Development work required for final design	6-88
6.9.6 Task 5.6.3 Final design	6-88
6.9.7 Task 5.6.4 Fabrication, installation and initial testing	6-88
6.9.8 Task 5.6.5 Operation	6-88
6.10 TASK GROUP 5.7 SPECIAL STUDIES	6-89
6.10.1 Objective	6-89
6.10.2 Schedule	6-89
6.10.3 Funding	6-89
6.10.4 Facilities	6-89
6.10.5 Task 5.7.1 Special electrochemical investigations	6-93
6.10.6 Task 5.7.2 Special optical methods	6-95
6.10.7 Task 5.7.3 Spectroelectrochemical studies	6-98
6.10.8 Task 5.7.4 Automation and application of analytical methods	6-100
6.10.9 Task 5.7.5 Evaluation of analytical methods for an integrated reactor surveillance system	6-100
REFERENCES FOR SECTION 6	6-102

	<u>Page</u>
7. REACTOR SAFETY	7-1
7.1 INTRODUCTION	7-1
7.1.1 Objectives	7-1
7.1.2 Scope	7-1
7.1.3 Relation to other technology areas	7-4
7.2 PROGRAM BUDGET AND SCHEDULE	7-4
7.2.1 Schedule	7-4
7.2.2 Budget	7-6
7.2.3 Key program milestones	7-6
7.3 REQUIREMENTS, BACKGROUND, AND STATUS OF DEVELOPMENT	7-6
7.3.1 Safety requirements	7-6
7.3.2 Background	7-8
7.3.3 Status	7-22
7.4 TASK GROUP 6.1 GUIDANCE STUDIES	7-26
7.4.1 Objective	7-26
7.4.2 Schedule and funding	7-26
7.4.3 Facilities	7-29
7.4.4 Task 6.1.1 Accident analysis	7-29
7.4.5 Task 6.1.2 Technology need identification	7-30
7.4.6 Task 6.1.3 Analytical methods	7-31
7.5 TASK GROUP 6.2 FISSION PRODUCT BEHAVIOR	7-31
7.5.1 Objective	7-31
7.5.2 Schedule and funding	7-32
7.5.3 Facilities	7-32
7.5.4 Task 6.2.1 Fission product release under accident conditions	7-32
7.5.5 Task 6.2.2 Tritium release under accident conditions	7-35
7.5.6 Task 6.2.3 Fission-product behavior in primary and secondary containments	7-36
7.6 TASK GROUP 6.3 PRIMARY-SYSTEM MATERIALS	7-36
7.6.1 Objective	7-36
7.6.2 Schedule and funding	7-36
7.6.3 Facilities	7-36
7.6.4 Task 6.3.1 Materials compatibility under accident conditions	7-36
7.6.5 Task 6.3.2 Metal properties and failure modes	7-39
7.6.6 Task 6.3.3 Graphite properties and failure modes	7-40
7.6.7 Task 6.3.4 Salt behavior at extreme conditions	7-40
7.7 TASK GROUP 6.4 COMPONENT AND SYSTEMS TECHNOLOGY	7-40
7.7.1 Objectives	7-40
7.7.2 Schedule and funding	7-40
7.7.3 Facilities	7-43
7.7.4 Task 6.4.1 Containment systems	7-43
7.7.5 Task 6.4.2 Seismic technology	7-44
7.7.6 Other safety technology tasks	7-44

	<u>Page</u>
7.8 TASK GROUP 6.5 SAFETY INSTRUMENTATION AND CONTROLS	7-45
7.8.1 Objective	7-45
7.8.2 Schedule and funding	7-45
7.8.3 Facilities	7-45
7.8.4 Task 6.5.1 Identification of instrumentation and controls safety needs	7-45
7.8.5 Technology development tasks	7-46
7.9 TASK GROUP 6.6 MAINTENANCE TECHNOLOGY	7-46
7.9.1 Objectives	7-46
7.9.2 Schedule and funding	7-46
7.9.3 Facilities	7-46
7.9.4 Task 6.6.1 Development of maintenance technology to enhance safety	7-47
7.10 TASK GROUP 6.7 SAFETY TECHNOLOGY OF PROCESSING AND WASTE STORAGE AND HANDLING	7-47
7.10.1 Objective	7-47
7.10.2 Schedule and funding	7-47
7.10.3 Facilities	7-47
REFERENCES FOR SECTION 7	7-48
8. REACTOR DESIGN AND ANALYSIS	8-1
8.1 INTRODUCTION	8-1
8.1.1 Objective	8-1
8.1.2 Scope	8-1
8.2 PROGRAM BUDGET AND SCHEDULE	8-3
8.2.1 Schedule	8-3
8.2.2 Budget	8-7
8.2.3 Key program milestones	8-7
8.3 BACKGROUND AND STATUS	8-9
8.3.1 Primary systems layout and structural design	8-10
8.3.2 Design methods	8-11
8.3.3 Capital costs	8-12
8.4 TASK GROUP 7.1 DESIGN STUDIES OF MSR POWER PLANTS	8-12
8.4.1 Objective	8-12
8.4.2 Schedule	8-13
8.4.3 Funding	8-13
8.4.4 Task 7.1.1 ORNL studies of 1000-MW(e) MSBR	8-13
8.4.5 Task 7.1.2 Industrial studies of 1000-MW(e) MSBR	8-19
8.4.6 Task 7.1.3 ORNL study of MSTR	8-20
8.4.7 Task 7.1.4 Industrial study of MSTR	8-20
8.4.8 Task 7.1.5 Studies of alternate designs and uses of MSR's	8-20
8.5 TASK GROUP 7.2 DESIGN TECHNOLOGY	8-21
8.5.1 Objectives	8-21
8.5.2 Schedule	8-21
8.5.3 Funding	8-21
8.5.4 Task 7.2.1 Establish design bases and methods for equipment for 1300°F operation	8-24
8.5.5 Task 7.2.2 Compile design properties	8-24

	<u>Page</u>
8.5.6 Task 7.2.3 Design reports on selected MSR systems	8-25
8.5.7 Task 7.2.4 Compilation of cost data and analysis of plant costs	8-26
8.5.8 Task 7.2.5 Molten-salt reactor information system	8-26
8.6 TASK GROUP 7.3 CODES AND STANDARDS	8-26
8.6.1 Objectives	8-26
8.6.2 Schedule	8-27
8.6.3 Funding	8-27
8.6.4 Task 7.3.1 Standards for MSTR	8-27
8.6.5 Task 7.3.2 Preparation of standards for MSBR's	8-30
8.6.6 Task 7.3.3 Preparation of code cases	8-30
8.7 TASK GROUP 7.4 LICENSING OF MSR's	8-30
8.7.1 Objective	8-30
8.7.2 Schedule	8-31
8.7.3 Funding	8-31
8.7.4 Task 7.4.1 Studies of MSBR licensing position	8-31
8.8 TASK GROUP 7.5 NUCLEAR ANALYSIS OF MSR POWER PLANTS	8-33
8.8.1 Objectives	8-33
8.8.2 Schedule	8-33
8.8.3 Funding	8-33
8.8.4 Task 7.5.1 Analysis of 1000-MW(e) MSBR's	8-33
8.8.5 Task 7.5.2 Control studies of MSBR plants	8-36
8.8.6 Task 7.5.3 Analysis of alternate MSR designs	8-36
8.8.7 Task 7.5.4 Computer code development	8-36
REFERENCES FOR SECTION 8	8-38
9. GRAPHITE DEVELOPMENT	9-1
9.1 INTRODUCTION	9-1
9.1.1 Objective	9-1
9.1.2 Scope	9-1
9.2 PROGRAM BUDGET AND SCHEDULE	9-3
9.2.1 Schedule and key program milestones	9-3
9.2.2 Budget	9-3
9.3 MATERIAL REQUIREMENTS, BACKGROUND, AND STATUS OF DEVELOPMENT	9-3
9.3.1 Material requirements	9-3
9.3.2 Background	9-8
9.3.3 Status of development	9-14
9.4 TASK GROUP 8.1 BASIC GRAPHITE STUDIES	9-16
9.4.1 Objective	9-16
9.4.2 Schedule	9-17
9.4.3 Funding	9-17
9.4.4 Facilities	9-17
9.4.5 Task 8.1.1 Irradiation damage and annealing in graphite single crystals	9-17

	<u>Page</u>
9.4.6 Task 8.1.2 Irradiation damage and annealing in polycrystalline graphite	9-17
9.5 TASK GROUP 8.2 GRAPHITE BASE STOCK DEVELOPMENT	9-17
9.5.1 Objective	9-21
9.5.2 Schedule	9-21
9.5.3 Funding	9-21
9.5.4 Facilities	9-21
9.5.5 Task 8.2.1 Evaluation of commercial graphites	9-21
9.5.6 Task 8.2.2 Development and evaluation of experimental graphites	9-25
9.6 TASK GROUP 8.3 SEALING GRAPHITE TO REDUCE PERMEABILITY	9-26
9.6.1 Objective	9-27
9.6.2 Schedule	9-27
9.6.3 Funding	9-27
9.6.4 Facilities	9-27
9.6.5 Task 8.3.1 Salt impregnation	9-27
9.6.6 Task 8.3.2 Carbon impregnation	9-27
9.6.7 Task 8.3.3 Carbon coatings	9-31
9.7 TASK GROUP 8.4 PHYSICAL PROPERTIES	9-31
9.7.1 Objective	9-32
9.7.2 Schedule	9-32
9.7.3 Funding	9-32
9.7.4 Facilities	9-32
9.7.5 Task 8.4.1 Thermal conductivity measurements	9-32
9.7.6 Task 8.4.2 Thermal expansion	9-32
9.7.7 Task 8.4.3 Electrical conductivity	9-35
9.7.8 Task 8.4.4 Elastic properties	9-35
9.8 TASK GROUP 8.5 EVALUATION TESTS FOR MSBR GRAPHITE	9-35
9.8.1 Objective	9-36
9.8.2 Schedule	9-36
9.8.3 Funding	9-36
9.8.4 Facilities	9-36
9.8.5 Task 8.5.1 Large-scale irradiation testing	9-36
9.8.6 Task 8.5.2 Analytical evaluation of reference graphite	9-39
REFERENCES FOR SECTION 9	9-40
10. REACTOR TECHNOLOGY DEVELOPMENT	10-1
10.1 INTRODUCTION	10-1
10.1.1 Objective	10-1
10.1.2 Scope	10-1
10.1.3 Relation to other activity areas	10-2
10.2 BUDGET AND SCHEDULE	10-2
10.2.1 Schedule	10-2
10.2.2 Funding	10-4
10.2.3 Key milestones	10-4

	<u>Page</u>
10.3	EXPERIENCE AND STATUS OF DEVELOPMENT 10-8
10.3.1	Fuel salt technology development 10-8
10.3.2	Coolant salt technology development 10-10
10.3.3	Steam-system technology development 10-12
10.3.4	Cover and off-gas system technology development 10-17
10.3.5	Salt pump development 10-18
10.3.6	Primary salt-salt heat exchanger development 10-19
10.3.7	Valve development 10-20
10.3.8	Control rod development 10-21
10.3.9	Containment and cell heating development 10-22
10.4	TASK GROUP 9.1 FUEL SALT TECHNOLOGY DEVELOPMENT 10-22
10.4.1	Objective 10-22
10.4.2	Schedule 10-23
10.4.3	Funding 10-23
10.4.4	Facilities 10-23
10.4.5	Task 9.1.1 Gas-Systems Technology Facility water tests 10-28
10.4.6	Task 9.1.2 Gas-Systems Technology Facility fuel-salt studies 10-29
10.4.7	Task 9.1.3 Afterheat removal systems development 10-31
10.4.8	Task 9.1.4 Salt sampler development 10-31
10.4.9	Task 9.1.5 Parametric evaluation studies for xenon removal 10-31
10.5	TASK GROUP 9.2 COOLANT-SALT TECHNOLOGY DEVELOPMENT 10-32
10.5.1	Objective 10-32
10.5.2	Schedule 10-32
10.5.3	Funding 10-32
10.5.4	Facilities 10-32
10.5.5	Task 9.2.1 CSTF studies (fluoroborate salt) 10-36
10.5.6	Task 9.2.2 Evaluation and design of larger components for coolant-salt technology development 10-38
10.6	TASK GROUP 9.3 STEAM TECHNOLOGY DEVELOPMENT 10-38
10.6.1	Objective 10-38
10.6.2	Schedule 10-38
10.6.3	Funding 10-42
10.6.4	Facilities 10-47
10.6.5	Task 9.3.1 Industrial steam generator conceptual design studies 10-48
10.6.6	Task 9.3.2 Design studies and small scale exploratory development 10-49
10.6.7	Task 9.3.3 Steam Generator Tube Test Stand design, construction, and operation 10-52
10.6.8	Task 9.3.4 Model testing in the Steam Generator Model Test Installation (SGMTI) - (Subtasks 9.3.4.1 through 9.3.4.11) 10-53

	<u>Page</u>
10.6.9 Task 9.3.5 Equipment and controls criteria development	10-54
10.7 TASK GROUP 9.4 COVER- AND OFF-GAS SYSTEM TECHNOLOGY DEVELOPMENT	10-55
10.7.1 Objective	10-55
10.7.2 Schedule	10-55
10.7.3 Funding	10-55
10.7.4 Facilities	10-55
10.7.5 Task 9.4.1 Handling of non-volatile constituents	10-55
10.7.6 Task 9.4.2 Handling of volatile constituents	10-59
10.8 TASK GROUP 9.5 SALT PUMP DEVELOPMENT	10-61
10.8.1 Objective	10-61
10.8.2 Schedule	10-61
10.8.3 Funding	10-61
10.8.4 Facilities	10-61
10.8.5 Task 9.5.1 Development of short-shaft pumps	10-64
10.8.6 Task 9.5.2 Development of molten-salt-lubricated bearings	10-65
10.9 TASK GROUP 9.6 PRIMARY SALT-SALT HEAT EXCHANGER DEVELOPMENT	10-66
10.9.1 Objective	10-66
10.9.2 Schedule	10-66
10.9.3 Funding	10-66
10.9.4 Facilities	10-66
10.9.5 Task 9.6.1 Status of technology report	10-66
10.9.6 Task 9.6.2 Define and perform development program	10-66
10.10 TASK GROUP 9.7 VALVE DEVELOPMENT	10-68
10.10.1 Objective	10-68
10.10.2 Schedule	10-68
10.10.3 Funding	10-68
10.10.4 Facilities	10-68
10.10.5 Task 9.7.1 Status of technology report	10-70
10.10.6 Task 9.7.2 Define and perform development program	10-70
10.11 TASK GROUP 9.8 CONTROL ROD DEVELOPMENT	10-70
10.11.1 Objective	10-70
10.11.2 Schedule	10-71
10.11.3 Funding	10-71
10.11.4 Facilities	10-71
10.11.5 Task 9.8.1 Define development program and construct test facility	10-73
10.11.6 Task 9.8.2 Perform development program	10-73
10.12 TASK GROUP 9.9 CONTAINMENT AND CELL HEATING	10-73
10.12.1 Objective	10-73
10.12.2 Schedule	10-73
10.12.3 Funding	10-73

	<u>Page</u>
10.12.4 Facilities	10-75
10.12.5 Task 9.9.1 Define development program	10-75
10.12.6 Task 9.9.2 Perform development program	10-75
10.13 TASK GROUP 9.10 COMPONENTS TEST FACILITY	10-75
10.13.1 Objective	10-75
10.13.2 Schedule	10-76
10.13.3 Funding	10-76
10.13.4 Facilities	10-76
10.13.5 Task 9.10.1 Conceptual design of the facility	10-76
10.13.6 Task 9.10.2 Title I and Title II design of the facility	10-79
10.13.7 Task 9.10.3 Construction of the facility	10-79
10.13.8 Task 9.10.4 Operation of the facility	10-79
REFERENCES FOR SECTION 10	10-79
11. MAINTENANCE	11-1
11.1 INTRODUCTION	11-1
11.1.1 Objective	11-1
11.1.2 Scope	11-2
11.2 PROGRAM BUDGET AND SCHEDULE	11-2
11.2.1 Schedule and key program milestones	11-2
11.2.2 Funding	11-2
11.3 REQUIREMENTS, BACKGROUND, AND STATUS OF DEVELOPMENT	11-2
11.3.1 Technological background	11-2
11.3.2 MSBR maintenance requirements	11-10
11.3.3 Status of development work	11-15
11.4 TASK GROUP 10.1 CONSIDERATIONS OF REMOTE MAINTENANCE DURING PRELIMINARY AND CONCEPTUAL DESIGN	11-16
11.4.1 Objective	11-16
11.4.2 Schedule	11-16
11.4.3 Funding	11-16
11.4.4 Task 10.1.1 Remote maintenance for 1000-MW(e) reference design	11-19
11.4.5 Task 10.1.2 Remote maintenance for demon- stration reactor	11-20
11.4.6 Task 10.1.3 Remote maintenance for test reactor	11-21
11.5 TASK GROUP 10.2 DEVELOPMENT OF REMOTE MAINTENANCE TECHNOLOGY	11-22
11.5.1 Objective	11-22
11.5.2 Schedule	11-22
11.5.3 Funding	11-22
11.5.4 Facilities	11-26
11.5.5 Task 10.2.1 Development of improved viewing devices	11-26
11.5.6 Task 10.2.2 Development of remote pipe cutting equipment	11-27
11.5.7 Task 10.2.3 Development of seal weld cutting and welding	11-27

	<u>Page</u>
11.5.8 Task 10.2.4 Development of preweld cleaning techniques	11-28
11.5.9 Task 10.2.5 Development of pipe spreading and alignment equipment	11-28
11.5.10 Task 10.2.6 Development of remote pipe welding techniques	11-29
11.6 TASK GROUP 10.3 DEVELOPMENT OF EQUIPMENT AND TECHNIQUES FOR POST WELD INSPECTION	11-29
11.6.1 Objective	11-29
11.6.2 Schedule	11-29
11.6.3 Funding	11-29
11.6.4 Facilities	11-29
11.6.5 Task 10.3.1 Interpretation of automatic welder records	11-33
11.6.6 Task 10.3.2 Adaptation of customary methods of nondestructive examination of welds	11-33
11.6.7 Task 10.3.3 Development of advanced methods for nondestructive examination of welds	11-34
REFERENCES FOR SECTION 11	11-36
12. INSTRUMENTATION AND CONTROLS DEVELOPMENT	12-1
12.1 INTRODUCTION	12-1
12.1.1 Objective	12-1
12.1.2 Scope	12-1
12.2 PROGRAM BUDGET AND SCHEDULE	12-2
12.2.1 Schedule and key program milestones	12-2
12.2.2 Budget	12-2
12.3 REQUIREMENTS, BACKGROUND, AND STATUS OF DEVELOPMENT	12-3
12.3.1 Requirements and current concepts	12-6
12.3.2 Experience with the MSRE and other facilities	12-8
12.3.3 Status of control analyses	12-10
12.3.4 Status of instrumentation development	12-14
12.4 TASK GROUP 11.1 CONTROL ANALYSES	12-16
12.4.1 Objective	12-16
12.4.2 Schedule	12-16
12.4.3 Funding	12-18
12.4.4 Task 11.1.1 Computer representation of plant operation	12-18
12.4.5 Task 11.1.2 Development of control methods	12-18
12.4.6 Task 11.1.3 Flux measurement analyses	12-18
12.4.7 Task 11.1.4 Calculation of pressure and temperature transients	12-20
12.4.8 Task 11.1.5 Determination of requirements for salt throttling valves	12-20
12.4.9 Task 11.1.6 Development of methods for inventory accounting and control	12-20
12.4.10 Task 11.1.7 Evaluation of need for fast scram capability	12-20
12.4.11 Task 11.1.8 Determination of processing plant instrumentation needs	12-21

	<u>Page</u>
12.5 TASK GROUP 11.2 INSTRUMENTATION DEVELOPMENT	12-21
12.5.1 Objective	12-21
12.5.2 Schedule	12-21
12.5.3 Funding	12-21
12.5.4 Facilities	12-21
12.5.5 Task 11.2.1 Development of high temperature flux sensors	12-24
12.5.6 Task 11.2.2 Development of improved pressure, flow, and level devices	12-24
12.5.7 Task 11.2.3 Assessment of instrumentation availability	12-25
REFERENCES FOR SECTION 12	12-26
13. MOLTEN-SALT TEST REACTOR MOCKUP	13-1
13.1 INCENTIVE FOR CONSTRUCTION AND OPERATION OF REACTOR MOCKUP	13-1
13.2 SCHEDULE AND REQUIRED FUNDING	13-1
14. MOLTEN-SALT TEST REACTOR	14-1
15. MOLTEN-SALT DEMONSTRATION REACTOR	15-1

1. PROGRAM PLAN OVERVIEW

1.1 INTRODUCTION AND SUMMARY

The objective of developing breeder reactors is to obtain a reliable and abundant source of energy through efficient use of our uranium and thorium resources. Molten-salt breeder reactors have attributes of fuel utilization, economics, and safety that make them well suited to this objective.¹ The highly successful operating experience of the Molten-Salt Reactor Experiment and the developments in chemical processes that have allowed an important simplification in the breeder concept support the belief that reactors having these characteristics can be successfully developed. Because they differ in many aspects from solid-fuel fast breeder reactors, MSBRs provide good insurance for the nation's energy supply in case major obstacles are encountered by the other concepts. In addition, the ability of the molten-salt reactor to be started up as a breeder or operated economically as a converter on plutonium, ^{235}U , or ^{233}U makes it particularly suitable as a companion for other types of reactors in a balanced fuel economy. It is believed that a strongly motivated and adequately funded program can lead to molten-salt breeder reactors that can play a major role in providing for our future energy needs.

This program plan for the development of the molten-salt breeder reactor (MSBR) is based on two primary ground rules provided by the AEC. First, a program will be undertaken to resolve the major uncertainties concerning the technical feasibility of molten-salt breeder reactors. Then, assuming favorable resolution of these uncertainties, development will proceed in support of design and construction of a molten-salt test reactor. The planning studies indicate that the crucial problem and critical path item during the first phase of the work is demonstration of an alloy for the structural material of the reactor primary system. The alloy must have satisfactory resistance to surface cracking when under stress in contact with the fuel salt in a reactor environment, satisfactory corrosion resistance in fuel and coolant salts, and satisfactory mechanical properties over the long-term under reactor conditions.

In addition to demonstrating an acceptable material of construction for the primary circuit, it is desirable to demonstrate, at least in principle, the solutions to several other problems of molten-salt reactors before proceeding with construction of a test reactor. A method should be demonstrated for preventing tritium that is produced in large quantity in the reactor fuel from transferring through the secondary coolant into the steam system from which it would be released to the environment. Information should be provided to assure that sodium fluoroborate will be satisfactory for use as the secondary coolant of a breeder reactor or that there is an acceptable alternate coolant. More complete information should be obtained on the level of oxide contamination in the proposed fuel salt that would cause troublesome precipitation of uranium from the

salt. The principles of any processes found necessary to control the oxide concentration should be demonstrated.

Some further assurance should be provided that graphite can be obtained commercially that will satisfy the minimum requirements for the core of a large breeder reactor. Continuous on-line processing of the fuel will be necessary to achieve a positive breeding gain in a molten-salt reactor. Operation of the major process steps in engineering equipment should be demonstrated.

Additional studies should be made for certain aspects of the reference design MSBR in order to assure that an acceptable reference design has been obtained. Finally, it will be necessary to show in a conceptual design that the proposed test reactor is feasible to build and maintain, that it can be operated safely, and that it can be expected to provide the information needed for proceeding with a larger demonstration plant.

It is estimated that with the funding currently projected for the Molten-Salt Reactor Program these objectives can be achieved by the end of FY 1978. Conceptual design of a test reactor (estimated total cost, \$450 million in FY 1975 dollars) and a test reactor mockup (estimated total cost, \$50 million in FY 1975 dollars) would be completed during FY 1979 for supporting requests for authorization of these projects in FY 1981. It is anticipated that operation of the test reactor would begin in FY 1989. The operating budget for research and development would rise from \$4 million during FY 1975 to \$11 million (in FY 1975 dollars) in FY 1978. If it is determined that the Program is to proceed with development for a test reactor, it is estimated that increases in research and development funds will be required to a level of \$13 to \$19 million per year (in FY 1975 dollars) for the later years. The actual budgets required for the years beyond FY 1978 will depend strongly on the size and complexity of the test reactor. Since these are presently unknown, the estimate of funds beyond FY 1979 involves large uncertainties.

1.2 STATUS OF TECHNOLOGY AND PLANNED DEVELOPMENT ACTIVITIES

In this subsection, a brief summary will be given of the status of the technology and planned development activities for each of the major areas of the Molten-Salt Reactor Program. A more detailed discussion of the status of technology, the development plans, the estimated schedule, the key program milestones, and the funds required for maintaining the indicated schedule is given in the remaining sections of this program plan for each of the major program areas.

1.2.1 Development of structural metal for primary and secondary circuits

Hastelloy N was developed for use with molten salts at the high temperatures required by aircraft power plants, and since it has good strength and good compatibility with fluoride salts, it was used for construction

of the 7.4-MW(t) Molten-Salt Reactor Experiment (MSRE). While the MSRE was being built, experiments revealed that the creep ductility of Hastelloy N is reduced by neutron irradiation. This embrittlement is caused by helium produced by thermal neutron captures in the alloy in contrast with the embrittlement due to void formation by fast neutrons that has been of concern for fast reactors. Analyses showed that the stresses in the MSRE would be sufficiently low for the reactor to be operated safely in spite of decreased ductility, but this will not necessarily be true of future reactors, and a development program was begun for finding a solution to the embrittlement problem. The approach followed was that of adding carbide-forming elements which have been used to ameliorate the embrittlement of stainless steel by fast neutrons, and 0.5 wt% Ti was found to sustain the ductility of Hastelloy N at the MSRE operating temperature of 1200°F. At 1300°F, the outlet temperature of the reference design MSBR, solution of the carbides in the alloy caused the remedy to be lost, but this was overcome by raising the titanium content to about 2%. Some further gain was made by adding niobium with the titanium, and hafnium in conjunction with titanium was found to be very effective. However, higher costs and problems with weldability decreased the desirability of hafnium-containing alloys.

Small commercial heats (100 lb) of 2%-Ti-modified Hastelloy N obtained from three vendors were found to have minimum creep ductilities that were greater than 4% at 1400°F after irradiation, which appears to be adequate. The material is fabricable into small tubes and weldable under high restraint; hence a solution to the embrittlement problem appears to have been found.

Extensive natural- and forced-circulation loop tests, as well as operation of the MSRE, have shown that the generalized corrosion rate of Hastelloy N in fuel salt is very low; however, examination of specimens from the MSRE indicated that standard Hastelloy N is subject to intergranular attack by the fission product tellurium. Subsequent tests showed that a number of materials are not attacked by tellurium, and among them are modifications of Hastelloy N. The 2%-Ti-modified Hastelloy N is observed to have increased resistance to tellurium attack, and the addition of small amounts of rare earths or niobium has been observed to prevent tellurium-induced intergranular attack.

The development program outlined in Section 2 includes further tests on small commercial heats of titanium-modified Hastelloy N for demonstrating that this material has adequate resistance to tellurium-induced intergranular attack, to irradiation embrittlement, and to generalized corrosion by fuel and coolant salts. It is anticipated that a decision on an acceptable alloy composition can be made by the end of FY 1976. At that time, several 10,000-lb commercial heats of modified Hastelloy N having this composition will be procured from two or more vendors for extensive evaluation tests. The tests will be concerned with complete characterization of the mechanical and physical properties of the large heats, and test data of 10,000-hr duration will be obtained in some cases. In-pile irradiation tests, as well as forced-circulation corrosion tests, will be

carried out for demonstrating the acceptability of the material for use in the primary circuit of an MSBR. The data thus obtained will serve as the basis for preparation and submission of a code case for the use of modified Hastelloy N in the MSBR primary circuit. Subsequent work on the development of materials for the primary and secondary circuits of molten-salt reactors will be concerned with obtaining long-term material test data and for further optimization of the alloy composition in order to further improve its materials properties.

1.2.2 Fuel processing

Operation of a molten-salt reactor as a high performance breeder is made possible by the continuous processing of the fuel salt in a facility that is located at the reactor site. As outlined in Section 3, the most important processing operations consist in removing the fission products (principally the rare earths) and isolating ^{233}Pa from the region of high neutron flux during its decay to ^{233}U in order to hold neutron absorption in these materials to acceptably low levels. It is also necessary that excess uranium produced in the system be removed for sale, that the fuel salt be maintained at the proper redox potential, and that oxide and corrosion products in the salt be maintained at tolerable levels.

Processing of MSBR fuel salt is based principally on three types of operations: removal of uranium from the salt by fluorination; selective removal of protactinium, rare earths, and other fission products from the salt by extraction into molten bismuth; and the hydrogen-reduction of UF_6 to UF_4 in the presence of the processed fuel carrier salt. In addition to these operations, there is the necessity for auxiliary support systems and operations required for close-coupled fuel processing.

The chemical basis on which the processing system is founded is well established; however, only small engineering experiments have been carried out to date, and a considerable engineering development effort remains. During the period FY 1975 - FY 1978, engineering experiments will be carried out for demonstrating the individual processing steps on a scale that ranges from 5 to 50% of that required for processing a 1000-MW(e) MSBR. This work will be carried out in the high bay area of the MSRE building (Bldg. 7503) where adequate space is available. Subsequent work on fuel processing will require the construction of a new building (the MSBR Processing Engineering Laboratory) in which the simultaneous operation of two or more process steps will be studied and additional development work carried out. Authorization for this facility, which is estimated to cost \$12 million, is required early in FY 1977. Subsequent to completion of engineering experiments dealing with a single process operation, a system (the Integrated Process Test Facility) will be constructed for the nonradioactive demonstration of processes and equipment for fuel processing at the pilot plant level. This facility will be used to demonstrate the safety and performance reliability of processing systems, to provide information for development of maintenance methods, and to provide a basis for evaluation of

continuous on-site processing of MSBR fuel salt. Sufficient information will result from operation of this and earlier engineering systems to allow detailed design of a processing plant for a test reactor and completion of conceptual design studies for the reference design MSBR.

- * The actinides constitute a long-term waste hazard for all nuclear power reactors, and it is desirable to develop means for recycling those produced in an MSBR to the reactor for transformation to less undesirable isotopes via transmutation and/or fission. Studies will be carried out during the early phases of work on fuel processing in order to determine the potential for attaining actinide separation and recycle in an MSBR and for the development of flowsheets and equipment necessary for effecting this result.

1.2.3 Fuel processing materials development

The materials requirements for MSBR fuel processing systems are dependent upon the processing methods utilized and the design of particular equipment items selected for effecting these processing steps. At this time, studies aimed at final selection of processing steps are being completed; hence, design of the processing plant equipment has not been carried out. Processes involving removal of uranium from fuel salt by fluorination and selective extraction of protactinium and fission products from fuel salt into liquid bismuth are considered the most promising methods available, and the current processing materials program is oriented in this direction.

It is not necessary that a single material be compatible with all environments anticipated in the processing plant since the system can be designed to allow segregation of particular portions of the plant. It is expected that at least two classes of materials will be required: one for the fluorination and fuel reconstitution steps and another for the reductive extraction steps. Nickel or a nickel-based alloy, which in some cases must be protected from corrosion by a layer of frozen salt, can be used for construction of fluorinators, and for those portions of a plant which contain fluorine, UF_6 , and HF. The corrosion of nickel and nickel-based alloys during fluorination operations has been evaluated extensively at ORNL. Much of the information has evolved from fuel recovery operations conducted with molten fluoride mixtures using irradiated metallic fuel elements. These data afford useful guidelines and background information for the selection of materials for the proposed fluorination and reconstitution steps, but show the importance of inerting the metal surfaces in fluorination systems with a passive frozen salt layer. In addition to compatibility evaluations, many years of experience have been accumulated in the fabrication and joining of this class of materials stemming from the construction of reactors and associated hardware as well as fluoride-salt purification equipment. Hence, very little research and development work of a materials nature will be required for those portions of the processing system that are fabricated from nickel or nickel-based alloys.

Materials which have shown good compatibility with bismuth solutions during limited tests include graphite and refractory metals such as tungsten, rhenium, molybdenum, and tantalum. Except for tantalum, these materials are difficult to fabricate and join. All oxidize rapidly in air at process temperatures and require atmospheric protection. It appears that the use of graphite for processing vessels and molybdenum or molybdenum alloys for interconnecting lines, agitators, and other components, represents the optimum combination of available materials for the reductive extraction portions of the processing system.

Although molybdenum has excellent resistance to corrosion by bismuth solutions or molten-fluoride mixtures, the use of molybdenum as a structural material requires highly specialized assembly procedures and imposes stringent limitations on equipment design from the standpoints of geometry and rigidity. Several advances in molybdenum fabrication techniques have been made at ORNL. Although helium leak-tight molybdenum welds have been produced consistently using both electron-beam and tungsten-arc techniques, the ductile-brittle transition of the resulting welds is above room temperature. Hence, each joint must be carefully designed to mechanically support the resulting welds. The results of work to date on molybdenum fabrication techniques have been encouraging, and it is believed that the material can be used in constructing small components for processing systems if proper attention is given to its fabrication characteristics.

In contrast to molybdenum, tantalum or the tantalum alloy T-111 is quite ductile in the as-welded condition, and several complex assemblies have been fabricated at ORNL using T-111. The resistance of this alloy to corrosion by bismuth solutions at 700°C is adequate; however, its resistance to corrosion by MSBR fuel carrier salt is unknown and is considered marginal from thermodynamic considerations. However, tantalum would withstand attack by molten LiCl which is present in some portions of the processing plant. Tantalum, or T-111, would require a higher degree of protection from interstitial impurities (O, C, N) than would molybdenum.

Graphite, which has excellent compatibility with fuel salt, also shows promise for containing bismuth solutions. Tests have shown no evidence of chemical interaction between graphite and bismuth containing up to 50 at. % lithium at 700°C, although the largest pores of commercially available graphite are penetrated to some extent by bismuth solutions. It is believed that the extent of penetration can be reduced to tolerable levels by the use of established surface-sealing techniques. Some work on graphite-to-graphite and graphite-to-metal joints will be required.

It is expected that a combination of graphite, molybdenum, and perhaps tantalum will be used in those portions of fuel processing systems that contain bismuth. Although tantalum alloys present few engineering developmental problems, it is expected that compatibility with molten fluorides and susceptibility to environmental contamination may limit their use. From an engineering point of view the use of graphite will require less development work than molybdenum and therefore major emphasis

will be placed on studies of graphite for the near term. The work to be undertaken in the longer term, however, allows for additional development of these materials for more extensive processing plant applications. Near-term compatibility results and fuel processing flowsheet developments will dictate the extent to which subsequent work will be undertaken for each of the materials.

As outlined in Section 4, work will be carried out initially to thoroughly investigate the chemical compatibility of potential container materials with fuel processing system environments under simulated processing conditions. The work will include investigations of the chemical compatibility of graphite, molybdenum, and tantalum with bismuth solutions and molten-salt mixtures as well as compatibility of suitable braze alloys with these solutions. The work will involve a number of capsule and thermal convection loop tests, as well as the operation of a graphite forced-convection loop for study of graphite corrosion in the presence of velocity and temperature gradients. If graphite is found to be unacceptable for use in processing plant applications, it may be necessary to operate additional forced convection loops that are constructed of tantalum.

Upon completion of the compatibility studies, the second phase of the work will be undertaken which involves the development of the required fabrication and joining techniques for materials whose compatibility has been demonstrated. For example, the joining of graphite will be studied by the techniques of brazing, adhesive bonding, high-temperature diffusion bonding, and the use of mechanical joints. The extent to which fabrication and joining techniques will be studied for molybdenum and tantalum alloys will be dependent upon the acceptability of graphite as a material of construction.

The third phase of the processing materials development activity will involve assistance during construction and operation of engineering experiments on fuel processing. Information on materials relative to the design and construction of experimental systems will be provided, and a surveillance program will be carried out to evaluate the effect of fuel processing operations on materials properties.

1.2.4 Chemical research and development

Molten-salt systems for high-temperature nuclear reactors have been under development since 1947, and extensive experience with fluoride-based salts has been accumulated. First developed were $\text{NaF-ZrF}_4\text{-UF}_4$ mixtures which fueled the Aircraft Reactor Experiment in 1954. As breeder reactor development received increased emphasis, a fuel composed of ${}^7\text{LiF-BeF}_2\text{-ZrF}_4\text{-UF}_4$ was developed and used in the Molten-Salt Reactor Experiment which operated for a total of 2.5 years beginning in 1966 and ending with the scheduled reactor shutdown. Extensive experience with fluoride-based molten salts was accumulated during this period; thus, the present MSBR fuel salt is

based on a long, well established background of experience and appears quite likely to meet the requirements of MSBRs with a minimum of additional research and development.

Previous work with coolant salts has been much more limited than that with fuel salts. The coolant salt for the Molten-Salt Reactor Experiment, a LiF-BeF₂ mixture, was used to reject heat to an air radiator. The melting point of the mixture is higher than is acceptable for use with a conventional steam system. The use of sodium fluoroborate as a coolant was first suggested in 1966 and experience with this salt has been accumulated since that time. Considerable additional research is needed to assure that the salt will be a satisfactory coolant. The salt is more corrosive toward Hastelloy N than is the fuel salt, and additional knowledge of corrosion reactions is required. Interactions of the coolant with fuel salt and with steam, which could result from steam generator leaks, need to be more fully considered, and additional measurements of physical properties are needed. Although fluoroborate can possibly be used as the coolant salt for MSBRs, there is incentive to consider alternative coolant materials and evaluation of alternate coolants will receive early attention in addition to research and development on fluoroborate.

The objective of work outlined in Section 5 is to obtain the chemical information necessary for the design of molten-salt breeder reactors. Work in the activity will include studies of fuel and coolant salt chemistry, measurement of the required physical properties, studies relating to tritium management and the delineation of operating parameters, and chemical studies related to off-design events such as temperature excursion or leaks.

Laboratory-scale studies will be carried out which will involve detailed investigations of the chemistry of MSBR fuel salt including measurement of solubility products for the actinide oxides, studies of the solution behavior of tellurium under various redox conditions, phase behavior of PuF₃, fuel-coolant interactions, and determination of physical property data. Similarly, understanding of the chemistry of the coolant salt must be greatly enhanced. Oxide and hydroxide chemistry in fluoroborate will receive intensive study along with investigations of the corrosion chemistry of this salt, methods for purifying the salt, and measurements of physical properties. An assessment of alternate coolants will be made.

✓ Tritium behavior in MSBR systems will also require a major effort. In addition to measurements of the permeability of various alloys to tritium, the possibility of sustaining an impermeable oxide film on the steam side of steam generator tubes will be fully explored. Measurements of the solubilities, diffusivities, etc. of tritium and HT in fuel and coolant salts will be made to aid in predicting tritium behavior in MSBR systems.

Studies of fission product chemistry will be focused chiefly on the chemistry of niobium, molybdenum, and other noble metals, and iodine in order to allow the accurate prediction of fission product distribution

in an MSBR. Fundamental studies of $\text{LiF-BeF}_2\text{-ThF}_4$ mixtures will include determination of activity coefficients of both major and minor components of that system. Porous electrodes will be used to study the chemistry of trace elements such as bismuth in MSBR fuel salt.

1.2.5 Analytical research and development

Substantial experience in the handling and analysis of nonradioactive fluoride melts was gained in the Aircraft Nuclear Propulsion Program. Methods were developed for analysis of most cationic constituents of interest as well as for fluoride and various forms of sulfur. Application of these techniques to the analysis of radioactive samples from the Molten-Salt Reactor Experiment required adaptation of the methods to remote, hot-cell operations. More recently, the development of improved analysis methods for discrete samples has continued as well as the incorporation of a variety of improved instrumental methods as they have become available.

Operation of an MSBR will require that adequate surveillance be maintained on the composition of various reactor streams. The more critical determinations are amenable to in-line measurement, and factors such as time, cost, and difficulty of analysis by the discrete-sample approach argue strongly that in-line techniques be developed when practical. There is also the necessity for development of in-line and special analytical techniques as required during the technology development activities of the Program. It is anticipated that the development of analytical techniques required for the technology phase of the Program will result in an adequate base for further development as required by test and demonstration reactors.

For the analysis of molten-salt streams, electroanalytical techniques such as voltammetry and potentiometry appear to offer the most convenient transducers for remote in-line measurements. For example, determination of the redox potential of MSBR fuel salt, as indicated by the $\text{U}^{3+}/\text{U}^{4+}$ ratio, as well as the concentration of corrosion product Cr^{2+} , has been made on a completely automated basis over a period of several months in thermal- and forced-convection test loops.

Other important analytical techniques include spectrophotometric methods for both salt and gas streams, and the use of transpiration methods whereby the composition of a molten-salt phase is inferred by analysis of a gas stream which has been equilibrated with the salt.

The work outlined in Section 6 allows for the development of devices which show promise for in-line applications as required during the development of MSBR technology as well as the operation of test and demonstration reactors. Characteristically, development of a particular in-line analytical device will be concentrated initially on the acquisition of basic information underlying operation of the device. There will then follow the testing of prototypic devices in nonradioactive systems.

Finally, those devices which show promise for reactor applications will be tested under conditions simulating the anticipated reactor environment with particular emphasis on the effects of radiation damage.

1.2.6 Reactor safety

Advances in the area of reactor technology, in general, and the work in the Aircraft Nuclear Propulsion and Molten-Salt Reactor Programs at ORNL have provided much of the information required to demonstrate the safety of molten-salt reactors. None of the work has indicated any safety issues that cannot be resolved with existing technology; however, MSR safety technology and the issues that are specific to this reactor concept have not been subjected to the comprehensive analysis and assessment that have been applied to other reactor concepts. Consequently, some additional technology development is required to demonstrate clearly the safety of these reactor systems.

The dynamics of MSBRs are influenced by the circulation of the fuel, but these effects are well understood and predictable. A prompt negative temperature coefficient and a long neutron lifetime contribute to the reactor stability, and, as shown by operation of the Molten-Salt Reactor Experiment, the small delayed neutron fraction of uranium-233 causes no problem. There is ample basis for confidence that damaging nuclear excursions are highly improbable. Of the potential sources of reactivity increases, the one that will require the most study is hideout of fissile material. Oxide precipitation could lead to such hideout, but conditions that would permit it can be safely avoided.

The afterheat situation in this reactor is unique. The major heat source is much less intense than in solid-fuel cores because in an MSBR the bulk of the fission products is incorporated in a large mass of fuel salt. Furthermore, this heat source can be transferred into a reliably cooled situation (the drain tank) under any accident condition. On the whole, afterheat promises to be less of a problem in MSBRs than in other reactors, and the dilute heat source makes the "China syndrome" of less concern. However, reliable cooling must be provided for those components and systems in which fission products are held or deposited.

The design-basis accident in an MSBR is a rupture in the fuel system that quickly spills the entire fuel inventory. Containment of the radioactivity in this event is the chief safety consideration for an MSBR. The containment must be tight, but the behavior of the spilled salt and its fission products is predictable, and designing to handle a spill safely appears to be straightforward. Further, iodine and strontium, two of the most hazardous fission products, remain in the salt as stable compounds.

As outlined in Section 7, studies within the area of reactor safety will be concerned principally with the characteristics and behavior of materials, components, subsystems, and systems in abnormal circumstances that would be expected to occur very infrequently, if at all, during the anticipated lifetime of any given molten-salt reactor plant. To the extent

that the more normal operations of a plant define system conditions that may be affected by accidents, some consideration must also be given to normal plant behavior. Existing safety and safety-related technology developed either within the Molten-Salt Reactor Program or within other domestic or foreign reactor safety programs will be assessed, adapted as required, and adopted for application to the safety effort whenever such adoptions are consistent with the overall program objectives. Additional safety technology will be developed only when unique, specified needs are identified.

1.2.7 Reactor design and analysis

Over the past twenty years, several molten-salt reactor plants have been examined conceptually, and two experimental molten-salt reactors were built and operated at ORNL. The Aircraft Reactor Experiment, which operated briefly in 1954, demonstrated the basic reactor concept; however, since the mission of that project was not central-station power generation, the reactor lacked many features that are important for large-scale breeder reactors. During the mid 1960's the Molten-Salt Reactor Experiment was operated for an extended period and yielded much valuable data on which power reactor concepts could be based. This system used a fuel salt generally similar to that proposed for the breeder, an unclad graphite moderator, a secondary coolant salt circuit, and a structural alloy of interest to the breeder concept.

Two basic breeder concepts have been studied: the first of these involved two radioactive primary coolants, a fissile stream of uranium, beryllium, and lithium fluorides, and a completely separate blanket or fertile salt of thorium, lithium, and beryllium fluorides. This system appeared to offer excellent breeding performance, and a relatively simple fuel processing plant; however, maintaining separation of the two fluids via graphite tubes in the core would be difficult in view of the dimensional changes which occur in graphite during neutron irradiation. Developments in the area of chemical processing and recognition of alternate neutronic design possibilities lead to the adoption of a single-fluid concept in which both the fertile and fissile materials are dissolved in the same primary salt.

For the past several years, the MSR conceptual design effort has been directed toward the single-fluid breeder system which features a single, large reactor vessel and four primary coolant pumps that circulate fuel salt between intermediate heat exchangers and the core. The reactor vessel contains unclad graphite to provide neutron moderation in three recognizable zones consisting of the core, the blanket, and the reflector. The fuel salt circulates through the three zones, which are not physically isolated from each other. The different neutronic effects in the zones are achieved by carefully selecting the fuel-to-moderator ratio for each zone. Each primary loop contains equipment for helium injection and removal to provide for stripping of ^{135}Xe and other volatile species. Some fuel salt is continually circulated between the drain tank and the

primary loops in order to cool portions of major components and the off-gas stream. The drain tank provides the initial holdup for decay of fission-product gases as well as afterheat removal capability if the fuel salt must be drained from the primary circuit.

Beyond the primary system, there are no major differences between the one-fluid and the older, two-fluid concepts. A secondary salt, sodium fluoroborate, transports the fission energy from each intermediate heat exchanger to a steam generator, which is coupled to a more-or-less conventional supercritical steam system for generation of electricity.

Although the basic reactor concept is reasonably well established, there are a number of aspects that have not yet been studied in sufficient detail to resolve all potential questions. These include the layout and design of all major parts of the primary system. In particular, additional stress analysis work is required to show that ordinary mechanical as well as thermal stresses throughout the system are compatible with design and life requirements for all conditions.

The physical arrangement of the graphite inside the reactor vessel is important in determining the performance of the system. Since graphite dimensional changes are an effect of neutron irradiation, the core must be designed to accommodate such changes without unacceptably degrading the reactor performance. Also, the graphite arrangement must allow for periodic replacement of at least some of the moderator. Additional work is required to ensure that radiation heating is appropriately handled in the reference design. All of the primary-system components within the primary containment must be physically supported in a way such as to accommodate thermal expansion effects and major disturbances such as earthquakes without loss of integrity.

Commercial-scale MSBRs will be designed mechanically for a useful life of 30 years at temperatures as high as 1300°F with numerous thermal cycles; however, the design pressure is relatively low. Much of the technology that is being developed for other reactor concepts will be applicable or at least adaptable to MSBR design problems; however, the structural material for the MSBR primary circuit (Hastelloy N) has different physical and aging characteristics than materials that are being developed for other high-temperature reactors. Therefore, considerable effort will be required to adapt, demonstrate the applicability of, and apply appropriate design methods to MSBR systems.

Capital cost studies on molten-salt reactor plants have been made in recent years by ORNL as well as several independent organizations. The conclusions from these studies are that MSBRs appear to be economically attractive in the U.S. power economy. Each of the studies was necessarily limited in precision by the state of development of the conceptual design that was subjected to analysis, and such limitations will continue until MSBRs reach commercial application. However, the levels of uncertainty can be expected to diminish as the reactor design evolves. Thus, capital costs and other aspects of MSBR economics will be frequently reassessed to ensure that design and development efforts are being applied to systems that are, in fact, attractive.

Finally, an important aspect of the capital and operating cost assessments for molten-salt reactors is determining the impact that various design options have on overall costs. The reference MSBR uses a particular design configuration, a particular secondary coolant, and a particular steam cycle. Various alternatives have been and will continue to be advanced from time to time including converter and simple burner reactors, smaller or multi-use reactors, alternate secondary coolants and coolant circuit configurations, and alternate steam cycles. The economic effects of such alternatives, singularly and in various combinations, will be examined to provide a sound basis for choosing the most desirable system(s) to be developed.

1.2.8 Graphite development

The graphite in a single-fluid MSBR serves no structural purpose other than to define the flow patterns of the salt in the reactor core and, of course, to support the forces resulting from its own weight and momentum transfer from the flowing salt. The requirements on the material are dictated most strongly by nuclear considerations, namely stability of the material against radiation-induced distortion, nonpenetrability of the fuel-bearing molten salt, and nonabsorption of xenon into the graphite. The practical limitations in meeting these requirements in turn impose conditions on the core design, specifically the necessity to provide for periodic graphite replacement and to limit the cross sectional area of the graphite prisms.

The graphite present in the Molten-Salt Reactor Experiment excluded salt, but the total radiation dose was too low to make radiation damage a problem, and exclusion of xenon was not a specification. Although a graphite stringer from the MSRE showed no effect of 2.5 years in contact with fuel salt, it would not have met the radiation damage and gas permeability requirements of an MSBR.

Radiation damage in most graphites results in shrinkage followed by expansion at neutron fluences below those of interest for MSBRs. However, special grades of graphite show little shrinkage and a longer period before rapid expansion begins. A commercially available graphite irradiated at MSBR temperatures was found to meet the four-year-life assumption of the reference design. Although a material having adequate radiation resistance appears to be available, a growing understanding of radiation behavior should lead to longer irradiation life, thereby decreasing the frequency with which part of the graphite must be replaced.

Sealing graphite to exclude xenon involves the use of pyrolytic carbon deposited in the surface pores or in a thin layer on the graphite surface. Either method will seal the graphite adequately, but the permeability of most of the small samples tested has increased excessively during neutron irradiation. The failures are thought to result from defects in the surface coating of the unirradiated material seen in photographs obtained using the scanning electron microscope. A new procedure for depositing

the coating has produced flaw-free samples that have shown improved irradiation properties. However, scale-up of the process to accommodate large pieces remains to be accomplished after a successful coating method has been developed.

If a suitable method for sealing the graphite is not developed the breeding ratio of the MSBR will decrease by 0.005 to 0.01 because of increased neutron captures in ^{135}Xe , with the specific change in breeding ratio depending on the effectiveness of the noble-gas sparging system.

Work will be carried out on graphite development which includes studies of a basic nature concerning damage mechanisms, fabrication studies to develop graphite with improved dimensional stability, development of sealing methods for reducing the permeability of the graphite to ^{135}Xe , and measurements of the physical properties of graphites having potential for MSBR application.

1.2.9 Reactor technology development

Although many of the components and systems for an MSBR power plant are similar to those for solid-fuel reactors, the design requirements for other components are different, and a number are unique to molten-salt systems. Many components were investigated in the development programs for the Aircraft Reactor Experiment and the Molten-Salt Reactor Experiment, but not all have been developed, and increases in size or performance are required in most cases. Vertical-shaft centrifugal pumps with overhung impellers were developed and used satisfactorily on the Aircraft Reactor Experiment (ARE), the Molten-Salt Reactor Experiment, and a number of salt loops. Although a 10- to 15-fold increase in capacity will be needed in progressing from the MSRE to full-size MSBRs, the same basic design as that used on the MSRE is specified in the reference MSBR design, and the scale-up should be relatively straightforward. The MSBR intermediate heat exchanger operated without difficulty, and analyses showed no decrease in performance throughout the plant life.

The aspects of the MSBR that differ from the MSRE, aside from size, have to do with the need for high performance in the MSBR to limit the fuel salt inventory, and the requirement that failed tubes can either be located and plugged in place or that a tube bundle or entire unit can be replaced. Both of these approaches create design problems. However, new techniques for plugging heat exchanger tubes being developed for other uses should be helpful.

There were no steam generators on the ARE and MSRE, and there has been no experience with the generation of steam using high-melting salts. The major problem is that in conventional steam cycles, the feed water enters the steam generator at a temperature below the melting point of the fluoroborate (725°F). As a result, unless other measures are taken, some salt would freeze on the tubes. Allowing a layer of salt to form might be acceptable, but in the reference concept, the steam cycle has been altered

to increase the inlet steam temperature. A small penalty results in the form of some additional equipment and a small loss in efficiency. Other ways of overcoming the salt-freezing problem also appear feasible, such as the reentrant tube approach that appears in some sodium-heated steam generator concepts. The likelihood of steam generator leaks that introduce moisture into the coolant will require that a cleanup system be provided. One way to prevent entry of tritium into the steam system may be to trap it in the coolant from which it would subsequently be removed. A single processing system for the coolant salt may be able to accomplish both requirements.

*The noble gases are only slightly soluble in fuel salt, and consequently, the fission product poisoning in an MSBR can be greatly reduced by sparging xenon from the salt as was demonstrated in the MSRE where over 80% of the ^{135}Xe was removed. However, the somewhat different sparging system proposed for the MSBR requires demonstration, and tests with salt are planned in a large engineering loop that has been completed recently. Studies will also be carried out in this system for determining the behavior of tritium in a large fuel salt circuit and the level of oxide contamination in the fuel salt that would cause troublesome precipitation of uranium from the salt. The principles of any processes found necessary to control the oxide concentration will be demonstrated.

Experience with the fluoroborate coolant proposed for the MSBR is not extensive, but an isothermal MSRE-scale loop and a number of small forced- and natural-convection loops have been operated with this salt. Fluoroborate has a greater tendency to pick up moisture than other salts that have been used in molten-salt reactors which makes it more corrosive, but the corrosion rate with clean salt is modest. The BF_3 vapor pressure requires special provisions in the cover gas system, but these have been worked out satisfactorily in the loops that have been operated. Studies will be carried out in the MSRE-scale engineering loop for determining the behavior of tritium and hydrogenous species in large coolant-salt circuits, for determining the distribution and behavior of corrosion products, and for developing further the technology required for use of fluoroborate as the secondary coolant for large MSBR systems.

In addition to the reactor technology areas discussed thus far, additional work will be carried out for the further development of primary heat exchangers, valves, control rods, and containment and cell heating methods, as well as the operation of a component test facility that will furnish much of the information required for design, construction, and operation of components for test and demonstration reactors.

1.2.10 Maintenance

The maintenance of all reactors requires the performance of various mechanical operations on equipment, which because of radioactive contamination and activation, is not directly accessible to maintenance personnel. Depending upon the level of activity, the size of equipment, and the design provisions for maintenance, anything from simple, local

shielding to fully remote manipulations may be required. The time required to do maintenance and the cost of the maintenance provisions increase with the degree of remoteness required.

The circulating fuel reactor has fission products and intense radiation with which to contend, not only in the reactor vessel, but also in all of the primary circuit through which the fuel salt circulates, the off-gas system, and in the fuel processing plant. Thus, this reactor concept requires radioactive maintenance of a greater scope than does a fixed-fuel reactor. On the other hand, the refueling operation is simpler, the radioactivity is retained on-site within one containment, and the necessity of a separate maintenance organization and equipment for a fuel reprocessing plant at another site is avoided.

Although maintenance design efforts cannot affect the size and activity level of the components in a reactor, much can be done in the design stages of the plant to influence strongly the degree of accessibility and the complexity of the maintenance operation. The maintenance concept for an MSBR is characterized by the following general principles:

- (1) Each system is composed of manageable units joined by suitable disconnects and lines which can be cut and rewelded remotely.
- (2) Each unit is accessible and replaceable from directly above through removable shielding.
- (3) Failed units are removed and replaced.

Much of the maintenance experience on which this concept rests resulted from application of this approach to the MSRE. Only the simplest of inspections and repairs could be done on failed equipment for the MSRE; however, in an MSBR, economic considerations will dictate consideration of more extensive repair capabilities.

It is clearly essential that maintenance design and development be concurrent with plant design, and this has been the case in conceptual design studies to date. These studies have not indicated any insurmountable problems in maintaining a 1000-MW(e) MSBR, and no serious conflicts have arisen in imposing the maintenance requirements on the reactor system.

Most of the techniques and many of the tools required for maintenance operations have been developed. Several versatile maintenance shields have been built and used. Optical viewing equipment -- window inserts, periscopes, adequate lighting -- all are available. The use of a shielded maintenance control room with windows, remotely operated TV, and remotely controlled cranes and tooling, has been successfully demonstrated. Remotely operable disconnects for electrical power, instrumentation, and service piping are at a satisfactory state of development. The remote fabrication of brazed joints in small system piping has been demonstrated in connection with the MSRE.

Two important techniques that are requisites for maintaining large power reactors are not available, however. They are remote welding and post-maintenance inspection. It is highly desirable from the standpoint of reliability that the MSBR fuel circulation system be of all-welded construction; thus, remote cutting and rewelding of the system piping will be required in the replacement of major components. Present generation automatic welding machines are reliable and capable of making high quality welds. These machines are not now capable of fully remote welding, and work will be carried out to adapt them for MSBR maintenance requirements.

The provisions in the MSBR for access to equipment for maintenance operations are equally applicable to in-service inspection. Dependable application of common methods for nondestructive inspection of welds will be difficult in high-temperature, high-radiation environments. Related methods currently being pursued in AEC and industrial programs promise to be successful, and the necessary work will be carried out for developing remote inspection methods for reactor welds under MSBR conditions.

1.2.11 Instrumentation and controls development

A significant effort in the development of MSRs will be devoted to the study of methods for controlling the reactor systems during startup, part load, full load, and under upset conditions to allow proper assessment of the operational and safety implications of various control approaches. While it appears that instrumentation and controls systems for MSBRs are relatively straightforward, a number of features inherent in this reactor type dictate further development of the technology associated with the control methods and systems.

Work in this area will be restricted initially to demonstrating that satisfactory control methods can be devised for the various operational modes necessary for molten-salt reactors, and the identification and development of instrumentation required for utilization of control methods having the greatest potential. The work will be concentrated primarily on the requirements for a 1000-MW(e) MSBR in order to identify technology areas requiring further development and demonstration before and during operation of molten-salt test and demonstration reactors. Studies will be carried out as necessary for characterizing transients which may occur during normal accident conditions with the preferred control methods in order that these conditions can be considered properly during the development of components and materials for the various reactor systems. As the designs progress for test and demonstration reactors, more detailed attention will be given to the control requirements for these reactors.

1.2.12 Molten-Salt Test Reactor mockup

The development work outlined previously will be aimed at providing the technology required for design of components for a molten-salt test reactor; however, a number of important aspects related to test reactor

design and operation cannot be fully demonstrated by the outlined work. For this reason, it appears desirable to design, construct, and operate a mockup consisting of important portions of the test reactor. The systems to be mocked up will consist largely of the primary and secondary circuits for the reactor plus portions of the steam-raising equipment. The mockup will be designed for operation in principally an isothermal manner and will be used for testing of full-scale prototypic components for the test reactor. It is intended that the test reactor mockup will be operated in a parallel manner with other component development facilities in which scaled-down versions of test reactor components will be tested over the full range of anticipated operating conditions.

Other benefits which will accrue from work associated with the test reactor mockup include obtaining experience during the design and construction phases which will be directly applicable to the test reactor, providing an opportunity for testing of remote maintenance equipment and techniques prior to test reactor operation, and allowing an opportunity for operator training in support of the test reactor.

1.2.13 Molten-Salt Test Reactor

A number of important questions related to the design of molten-salt breeder reactors can be answered only through the construction and operation of a test reactor. These include the need for additional reactor operating and maintenance experience under conditions more closely resembling molten-salt power reactors in order to obtain improved estimates for the availability and maintenance costs of molten-salt breeder reactors, the need for operation of a continuous processing system in which representative quantities of protactinium and fission products are present, and the need for an improved definition of the behavior and distribution of noble-metal fission products and tritium in a reactor system. Finally, there is the need for the ultimate demonstration that a satisfactory material of construction for the reactor primary circuit has been developed and the need for obtaining experience with design, fabrication, and operation of larger reactor components.

Neither the optimum size nor complexity of the test reactor has been determined at this time. If at all possible, the test reactor should be sufficiently large that experience can be obtained with components that are full scale for a demonstration reactor. It is anticipated that the preliminary conceptual design studies outlined in Section 8 of this program plan will lead to a clear definition of the design and operational requirements for the test reactor. Final design of the system will be completed by the end of FY 1985, and operation should begin early in FY 1989. The estimated cost for the design and construction of the test reactor is \$450 million (in FY 1975 dollars). This estimate should be considered to be very preliminary since it is not supported by detailed design or cost estimation.

1.2.14 Molten-Salt Demonstration Reactor

Conceptual design of a molten-salt demonstration reactor would be initiated during FY 1982 in support of a request for obtaining FY 1985 authorization for the design and construction of a demonstration reactor.

1.3 KEY PROGRAM MILESTONES

Selected key program milestones and the time at which they occur are defined and shown in Tables 1.3.1 thru 1.3.4. A more detailed listing of key program milestones for each of the Program areas is given in the respective section of this program plan.

1.4 ESTIMATED FUND REQUIREMENTS

The operating fund requirements, in FY 1975 dollars, for the various development areas are summarized in Table 1.4.1. Capital equipment fund requirements are summarized in Table 1.4.2. GPP funds will be required in FY 1976 in the amount of \$300,000 (in FY 1975 dollars) for modification of the Mechanical Properties Evaluation Laboratory to allow continued development of a structural material for the MSBR primary circuit, and in the amount of \$355,000 (in FY 1975 dollars) for conversion of Cell 2, Building 3019 to an alpha-containment laboratory where the Protactinium Isolation Demonstration Experiment will be carried out in connection with fuel processing development. A listing of fund requirements for capital projects is shown in Table 1.4.3.

Table 1.3.1. Schedule for molten-salt reactor development showing selected key program milestones
(See Table 1.3.3 for remaining development areas.)

Development area	Fiscal year												
	1975	1976	1977	1978	1979	1980	1981	1982	1983	1984	1985	1986	
Development of structural materials			▽ ^a ▽ ^b		▽ ^c								
Fuel processing			▽ ^d	▽ ^e	▽ ^f		▽ ^g	▽ ^h					▽ ⁱ
Fuel processing materials		▽ ^j			▽ ^k								
Chemical research and development	▽ ^l		▽ ^m	▽ ⁿ	▽ ^o								▽ ^p
Analytical research and development			▽ ^q			▽ ^r						▽ ^s	▽ ^t
Reactor safety					▽ ^u					▽ ^v		▽ ^w	

Table 1.3.2. Description of selected key program milestones for molten-salt reactor development appearing in Table 1.3.1 (See following tables for remaining development areas.)

Milestone	Description
a	Determine acceptable alloy composition for MSBR primary circuit.
b	Procure several large commercial heats of alloy chosen for MSBR primary circuit.
c	Submit ASME code case for use of alloy chosen for MSBR primary circuit.
d	Receive authorization of MSBR Processing Engineering Laboratory.
e	Receive authorization of Integrated Process Test Facility.
f	Complete operation of engineering facilities for study of single process steps.
g	Complete construction of MSBR Processing Test Facility.
h	Begin operation of Integrated Process Test Facility.
i	Complete operation of Integrated Process Test Facility.
j	Complete compatibility studies relating to selection of graphite for Integrated Process Test Facility.
k	Complete surveillance studies on samples from engineering facilities for study of individual process steps.
l	Complete interim report on alternate coolant evaluation.
m	Establish solubility of tellurium and tellurides in fuel salt.
n	Complete final evaluation of alternate coolants.
o	Complete measurements of tritium permeation of clean and oxidized metals.
p	Complete data required for modeling of tritium behavior in MSBRs.
q	Complete development of electrochemical and spectrophotometric analysis methods for corrosion products and tritium in sodium fluoroborate.
r	Complete development of in-line method for oxide analysis in fuel salt.
s	Complete evaluation of γ -spectrometry capabilities.
t	Complete recommendations for analysis requirements of MSBRs.
u	Complete safety analyses required to support request for authorization of MSTR and MSTR mockup.
v	Complete development of safety technology required for MSTR licensing.
w	Complete safety analysis work for MSTR.

Table 1.3.3. Schedule for molten-salt reactor development showing selected key program milestones
 (See Table 1.3.1 for remaining development areas.)

Development area	Fiscal year											
	1975	1976	1977	1978	1979	1980	1981	1982	1983	1984	1985	1986
Reactor design and analysis			▽ ^a	▽ ^b ▽ ^c		▽ ^d ▽ ^e						
Graphite development				▽ ^f ▽ ^g		▽ ^h ▽ ⁱ ▽ ^j						
Reactor technology		▽ ^k ▽ ^l	▽ ^m			▽ ⁿ	▽ ^o ▽ ^p	▽ ^q	▽ ^r ▽ ^s		▽ ^t ▽ ^u	
Maintenance						▽ ^v		▽ ^w				
Instrumentation and controls												▽ ^x
MSTR mockup						▽ ^y	▽ ^z			▽ ^{a'}	▽ ^{b'}	
MSTR						▽ ^y	▽ ^z					▽ ^{a'}
MSDR											▽ ^y	▽ ^z

Table 1.3.4. Description of selected key program milestones for molten-salt reactor development appearing in Table 1.3.3 (See preceding tables for remaining development areas.)

Milestone	Description
a	Complete studies of alternate designs and uses for MSRs.
b	Establish interim high-temperature design methods for MSBR materials.
c	Complete preliminary conceptual design of 1000-MW(e) MSBR.
d	Establish design criteria for 1300°F operation.
e	Complete design reports on selected MSR supporting systems.
f	Determine reference graphite for MSBR moderator from commercial graphites.
g	Determine best method for reducing permeability of graphite to ^{135}Xe .
h	Complete development of model for graphite single crystals relating damage to electron and neutron irradiation. Begin irradiation of prototypic moderator element made of reference graphite.
i	Begin fabrication of experimental quantities of graphites having improved irradiation damage resistance.
j	Complete measurements of physical property variations of reference graphite in irradiated and unirradiated conditions. Begin irradiation of prototypic moderator element.
k	Establish feasibility of using lower steam system feedwater temperatures.
l	Obtain industrial recommendations for steam generator development program.
m	Complete definitive engineering tests on removal of xenon from fuel salt. Complete tests for determining behavior of tritium and corrosion products in fluoroborate coolant salt.
n	Complete resolution of all problems pertaining to behavior of tritium in fuel salt system. Complete reevaluation of steam generator development program. Complete preliminary valve development required for MSTR design. Obtain authorization of Component Test Facility.
o	Complete construction of Steam Generator Tube Test Stand, pressure relief system, and 3-MW test assembly.
p	Complete design of MSTR prototype pump and pump test stand.
q	Complete construction of Component Test Facility.

Table 1.3.4 (continued)

Milestone	Description
r	Complete tests in Steam Generator Tube Test Stand.
s	Complete construction of 30-MW model steam generator and Steam Generator Model Test Installation. Complete construction of MSTR prototype pump and pump test stand.
t	Complete large-scale demonstration tests of coolant-salt technology. Complete resolution of all problems associated with cover and off-gas systems. Complete all primary heat exchanger work required for MSTR design.
u	Begin tests of prototypic MSTR steam generator in MSTR mockup.
v	Complete determination of MSBR maintenance requirements.
w	Complete maintenance development required for MSTR design.
x	Complete development of MSBR control methods.
y	Complete conceptual design.
z	Obtain authorization.
a'	Complete final design.
b'	Complete construction.

Table 1.4.1. Summary of operating fund requirements for molten-salt reactor development
(costs in thousands of FY 1975 dollars)

	Fiscal year											
	1975	1976	1977	1978	1979	1980	1981	1982	1983	1984	1985	1986
Development of structural materials	1671	2150	2327	2,764	1,468	1,350	1,200	1,240	1,180	1,200	1,020	
Fuel processing	931	1600	1825	1,795	595	465	591	2,458	2,824	2,824	2,700	
Fuel processing materials development	123	300	393	461	489	375	75	75	30	30	30	
Chemical research and development	473	710	811	913	1,014	1,014	1,255	1,450	1,230	610	440	
Analytical research and development	180	290	360	410	480	515	553	550	513	460	365	
Reactor safety	90	233	270	360	305	520	645	750	845	950	1000	
Reactor design and analysis	122	467	530	540	695	1,000	1,000	850	800	750	700	
Graphite development		450	514	579	643	1,210	1,285	1,260	1,260	1,210	1,110	
Reactor technology	410	800	970	1,080	1,440	2,595	3,735	3,500	3,750	4,000	4,000	
Maintenance				50	200	486	791	597	518	486	435	
Instrumentation and controls				48	141	270	370	545	550	600	600	
Total MSBR technology	4000	7000	8000	9,000	7,470	9,800	11,500	13,275	13,500	13,120	12,400	
MSTR mockup					630	700	850	1,500	2,500	3,000	3,000	
MSTR				2,000	4,750	2,500	2,650	2,500	3,000	3,500	4,000	
Total reactor design and development				2,000	5,380	3,200	3,500	4,000	5,500	6,500	7,000	
Total MSBR technology and reactor design and development	4000	7000	8000	11,000	12,850	13,000	15,000	17,275	19,000	19,620	19,400	

Table 1.4.2. Summary of capital equipment fund requirements for molten-salt reactor development
(costs in thousands of FY 1975 dollars)

	Fiscal year											
	1975	1976	1977	1978	1979	1980	1981	1982	1983	1984	1985	1986
Development of structural materials	735	900	1155	390	75	130	115	135	105	115	105	
Fuel processing	55	715	425			400		200	300	400	300	
Fuel processing materials development		85	620	125	45	25	25	25	25	25		
Chemical research and development	72	157	273	238	139	314	251	267	144	41	4	
Analytical research and development	25	208	153	156	141	192	97	20		30		
Graphite development		80	145	230	120	630	570	210	210	130	120	
Reactor technology	28	66	35	60	290	70	77	425	671	829	1023	
Maintenance				200	105	100	65	100	65			
Instrumentation and controls						170						
Total capital equipment funds	915	2211	2806	1399	915	2031	1200	1382	1520	1570	1552	

Table 1.4.3. Capital project funds required for molten-salt reactor development
(costs in millions of FY 1975 dollars)

	Fiscal year						
	1976	1977	1978	1979	1980	1981	1982
MSBR Processing Engineering Laboratory		12					
Integrated Process Test Facility			7				
Steam generator tube test stand				4			
Pump test stand					1		
Components Test Facility					10		
Model steam generator test installation						20	
Molten salt test reactor mockup					50		
Molten salt test reactor						450	
Total capital project funds		12	7	4	61	470	

REFERENCES FOR SECTION 1

1. *The Development Status of Molten-Salt Breeder Reactors*, ORNL-4812 (August 1972).

2. DEVELOPMENT OF STRUCTURAL METAL FOR PRIMARY AND SECONDARY CIRCUITS

2.1 INTRODUCTION

The material used in constructing the MSBR primary circuit will operate over the temperature range of 1050 to 1300°F. The environment outside the primary circuit will be oxidizing and comprised primarily of nitrogen. The interior surfaces of the primary circuit will be exposed to salt containing fission products, and will receive a maximum thermal neutron fluence of about 1×10^{21} neutrons/cm². The operating lifetime of a reactor will be about 250,000 hr (about 30 yr). The material must be fabricable into many products, and capable of being formed and welded by conventional shop techniques.

In the secondary circuit, the material will be exposed to the coolant salt over the temperature range 850 to 1150°F under much the same conditions as for the primary circuit except for the absence of fission products and neutron irradiation. Thus, the activities required for development of material for the primary circuit will suffice for the secondary circuit if supplanted by information on the compatibility of the material with the coolant salt.

2.1.1 Objective

The objective of this program is to develop a material that will operate successfully under the conditions described above.

2.1.2 Scope

Hastelloy N was the sole metallic material used in constructing the MSRE. Although the mission of that reactor was not compromised, experience revealed that Hastelloy N was embrittled by neutron irradiation and formed intergranular cracks due to interaction with the fission product tellurium. More recent experiments have shown that chemical modifications of Hastelloy N are quite effective in increasing the resistance of the material to embrittlement by neutron irradiation and to cracking by tellurium. The activities described in the remainder of this section are aimed at continuing the alloy development effort in order to obtain a code-approved structural material for the primary and secondary circuit of molten-salt reactors having adequate resistance to embrittlement by neutron irradiation and attack by the fission product tellurium. The work areas to be undertaken in this activity consist of (1) determination of an acceptable alloy composition, (2) procurement of commercial heats of the selected alloy, (3) extensive evaluation tests on product shapes from the commercial heats, (4) the development of design methods and data for the selected alloy and submission of an ASME code case for use of the material in nuclear service, and (5) studies for optimization of the alloy properties.

2.1.2.1 Task Group 1.1 Selection of alloy composition

Tests will be carried out to determine basic information related to chemical interactions between Hastelloy N, tellurium and salt. The reaction products formed in the alloy will be identified and rate data associated with their formation will be measured. Various alloys will be irradiated to determine their resistance to neutron embrittlement. An important variable in these studies will be the alloy composition. Emphasis will be placed on a modified Hastelloy N having a base composition of 12% Mo, 7% Cr, 0.05% C, balance Ni. Additions of Ti up to 2% and rare earths (e.g., Ce, La) up to 0.02% will be evaluated. The end result of work in this task group will be the selection of an alloy with adequate resistance to neutron embrittlement and intergranular cracking for use in molten-salt reactors having a 30-yr life.

2.1.2.2 Task Group 1.2 Procurement of commercial heats

After the composition of modified Hastelloy N has been fixed by the work in Task Group 1.1, at least four large commercial heats (~10,000 lb each) will be procured for evaluation. The specifications written for the procurement of this material will form the basis for future procurement for construction of reactor systems. Orders for the four heats will be placed with at least two vendors by competitive bidding. The material will be obtained in product forms typically required in reactor construction. These materials will be carefully catalogued and evaluated extensively in Task Group 1.3.

2.1.2.3 Task Group 1.3 Evaluation of commercial heats

Product forms from the four large heats will be evaluated with respect to several properties including weldability, mechanical properties, compatibility with fuel salt containing fission products and coolant salt, and physical properties. These tests will confirm the desirability of the composition selected and will provide the data base required for design of MSR components and systems. Tests of at least 10,000 hr duration will be carried out. The quality of testing will be maintained at a high level to provide information having the precision necessary for design purposes.

2.1.2.4 Task Group 1.4 Development of analytical design methods--ASME code case submission

The data obtained in Task Group 1.3 will be analyzed and correlated in analytical forms that are most easily used by designers. Model tests necessary to develop high-temperature design methods will be carried out. The data and the design methods will allow preparation and submission of a high-temperature ASME Pressure Vessel Code Case for use of the material in nuclear service.

2.1.2.5 Task Group 1.5 Long-term materials test

The tests performed in Task Group 1.3 will be adequate for the design of a molten-salt test reactor. However, the operation of this and subsequent reactors would profit from the availability of longer-term information. Some of the corrosion, creep, and fuel irradiation tests initiated in Task Group 1.3 will be continued to provide this information.

2.1.2.6 Task Group 1.6 Alloy optimization

Although the alloy that will result from work in Task Groups 1.1 through 1.4 should be adequate for construction of a molten-salt test reactor (Section 14), a demonstration reactor (Section 15), and commercial power reactors, it is likely that further alloy development will lead to materials having improved characteristics which may allow a higher reactor outlet salt temperature or significant relaxation of design and operational constraints. Some attention will also be given in this task group to the use of cheaper, more readily available materials for construction of power reactors.

2.2 PROGRAM BUDGET AND SCHEDULE

2.2.1 Schedule and key program milestones

The schedule for work in this activity is given in Table 2.2.1.1. The key program milestones associated with the development of the structural metal for the MSR primary and secondary circuits are listed in Table 2.2.1.2 and occur at the times indicated in Table 2.2.1.1.

2.2.2 Funding

Operating funds required by this activity are summarized in Table 2.2.2.1. Capital equipment funds are summarized in Table 2.2.2.2. GPP funds in the amount of \$300,000 will be required during FY 1976 for modification of the Mechanical Property Test Laboratory.

2.3 MATERIAL REQUIREMENTS, BACKGROUND, AND STATUS OF DEVELOPMENT

2.3.1 Material requirements

The material used in the primary circuit will be exposed to fertile-fissile salt containing fission products over the temperature range of 1050 to 1300°F. In the intermediate heat exchanger and in the remainder of the secondary circuit this material will be exposed to the coolant salt. The outside surfaces of the alloy will be exposed to the cell environment which will likely be nitrogen containing 2 to 5% oxygen. No metallic structural members will be located in the highest flux

Table 2.2.1.1. Schedule for development of structural metal for primary and secondary circuits

	Fiscal year												
	1975	1976	1977	1978	1979	1980	1981	1982	1983	1984	1985	1986	
1.1 Determination of alloy composition	a ▽	b ▽	c ▽	d ▽	e ▽								
1.2 Procurement of commercial heats			f ▽	g ▽									
1.3 Evaluation of commercial heats		h ▽	i ▽	j ▽	k ▽								
1.4 Development of analytical design methods - ASME Code			l ▽	m ▽	n ▽								
1.5 Long-term material tests					o ▽								
1.6 Alloy optimization					p ▽								

Table 2.2.1.2. Key milestones for development of structural metal for primary and secondary circuits

-
- a Receipt of small commercial heats containing 2% Ti plus ~0.01% rare earths. Begin mechanical property and compatibility tests on 2% Ti-rare-earth heats. Receipt of several laboratory melts containing various amounts of Ti and Nb. Begin mechanical property and compatibility tests on Ti-Nb modified alloys.
 - b Receipt of products of 10,000-lb heat of 2% Ti-modified Hastelloy N. Begin mechanical property and compatibility tests on 10,000-lb heat.
 - c Start forced convection corrosion loop (FCL-3) constructed of 10,000-lb heat for basic fuel salt corrosion studies. Begin ~1 yr irradiation of fuel pins made of most desirable alloy.
 - d Start forced convection corrosion loop (FCL-4) constructed of 10,000-lb heat for fuel salt-Te corrosion studies.
 - e Start forced convection corrosion loop (FCL-5) constructed of 10,000-lb heat for coolant salt corrosion studies.
 - f Prepare specifications and solicit bids from potential vendors for four heats of desired composition.
 - g Begin receipt of products from four large heats.
 - h Begin construction and checkout of equipment required for mechanical property tests on four large heats.
 - i Begin evaluation of four large heats by weldability, mechanical property, and compatibility tests.
 - j Begin operation of forced circulation loops (FCL-6 and 7) constructed of modified alloy and circulating fuel salt.
 - k Begin operation of forced circulation loops (FCL-8 and 9) constructed of modified alloy and circulating coolant salt.
 - l Begin detailed analysis of mechanical property data.
 - m Begin development of design methods for modified alloy.
 - n Submission of data package for ASME Code Approval.
 - o Begin studies to raise allowable temperature for use of modified alloy.
 - p Begin long-term mechanical property and compatibility tests on modified alloy.
-

Table 2.2.2.1. Operating fund requirements for development of structural metal
for primary and secondary circuits
(costs in 1000 dollars)

	Fiscal year												
	1975	1976	1977	1978	1979	1980	1981	1982	1983	1984	1985	1986	
1.1 Determination of alloy composition	1671	1693											
1.2 Procurement of commercial heats			400										
1.3 Evaluation of commercial heats		457	1712	2047									
1.4 Development of analytical design methods - ASME Code Case Submission			215	717	168								
1.5 Long-term material tests					1000	1000	800	800	700	700	500		
1.6 Alloy optimization					300	350	400	440	480	500	520		
Total operating funds for development of structural metal	1671	2150	2327	2764	1468	1350	1200	1240	1180	1200	1020		

Table 2.2.2.2. Summary of capital equipment funds required for development of structural metal for primary and secondary circuits (costs in 1000 dollars)

	Fiscal year												
	1975	1976	1977	1978	1979	1980	1981	1982	1983	1984	1985	1986	
1.1 Determination of alloy composition	735	563											
1.2 Procurement of commercial heats			10										
1.3 Evaluation of commercial heats		337	1095	290									
1.4 Development of analytical design methods - Code Case Submission			50	100									
1.5 Long-term material tests					40	60	35	55	30	40	30		
1.6 Alloy optimization					35	70	80	80	75	75	75		
Total capital equipment funds	735	900	1155	390	75	130	115	135	105	115	105		

regions, but the vessel wall will be exposed to peak thermal and fast (>0.8 MeV) fluxes of 6.5×10^{12} and 1.2×10^{11} neutrons \cdot cm⁻² \cdot sec⁻¹. With a 30-year lifetime and an 80% load factor, the peak thermal and fast fluences will be 5×10^{21} and 1×10^{20} neutrons/cm², respectively.

An obvious requirement of the structural material is that it be fabricable into the forms needed to build an engineering system. The basic shapes required include plate, piping, tubing, and forgings. For assembly, the material must be weldable both under well-controlled shop conditions and in the field.

2.3.2 Background

2.3.2.1 Initial objectives and screening tests

The nuclear-powered aircraft application for which molten-salt reactors were originally developed required that the fuel salt operate at around 1500°F. Inconel 600, out of which the Aircraft Reactor Experiment was built, was not strong enough and corroded too rapidly at the design temperature for long-term use. The existing alloys were screened for corrosion resistance at this temperature and only two were found to be satisfactory — Hastelloy B (Ni-28% Mo-5% Fe) and Hastelloy W (Ni-25% Mo-5% Cr-5% Fe).^{1,2} However, both aged at the service temperature and became quite brittle due to the formation of Ni-Mo intermetallic compounds. These observations led to an alloy development program in which INOR-8, or Hastelloy N, was developed.^{3,4}

2.3.2.2 The metallurgy of Hastelloy N

The commercial chemical specifications for "standard" Hastelloy N out of which the MSRE was built, and for an alloy modified to give it improved properties, are shown in Table 2.3.2.2. The molybdenum is present for strengthening, but is not in sufficient concentration to cause the formation of brittle compounds. Chromium is added in the minimum concentration required to form a spinel-type oxide.⁵ Iron is allowed in sufficient quantities to permit chromium to be added as ferrochrome; however, it is not a critical element in the alloy. Manganese has some effect on the alloy by reacting with sulfur, but sulfur is usually dealt with during melting by additions of elements such as magnesium. Carbon is important because it forms carbides that improve the strength and restrict grain growth during high-temperature treatments. Elements such as sulfur, phosphorus, and boron, and many others not included in Table 2.3.2.2 are tramp or impurity elements that serve no known useful purpose in the alloy. These elements generally have little effect on the alloy behavior as long as they are kept at reasonable concentrations.

Table 2.3.2.2. Chemical composition of Hastelloy N

Element	Content (% by weight)*	
	Standard alloy	Favored modified alloy
Nickel	Base	Base
Molybdenum	15-18	11-13
Chromium	6-8	6-8
Iron	5	0.1**
Manganese	1	0.15-0.25**
Silicon	1	0.1
Phosphorus	0.015	0.01
Sulfur	0.020	0.01
Boron	0.01	0.001
Titanium		2

* Single values are maximum amounts allowed. The actual concentrations of these elements in an alloy can be much lower.

** These elements are not felt to be very important. Alloys are now being purchased with the small concentration specified, but the specification may be changed in the future to allow a higher concentration.

Silicon is introduced by the refractories used in the air melting practice and is an important element. Hastelloy N containing 0.5 to 1% silicon contains stringers of coarse carbides and will form some fine carbides during annealing at 1200 to 1600°F.⁶ These carbides are of the M_6C type, with M having the composition of 27.9% Ni, 3.3% Si, 0.6% Fe, 56.1% Mo, and 40% Cr. They are not easily dissolved during annealing, so the alloy has stable properties over a broad range of operating temperatures. However, these predominantly coarse carbide precipitates produce less desirable alloy properties than fine carbide precipitates of the MC and M_2C type. Several melting practices are currently in use that result in low silicon concentrations. The carbides in these alloys are of the M_2C type, where M is 80 to 90% molybdenum with the remainder chromium. They are more easily dissolved than the M_6C type which contains silicon.

Thus, Hastelloy N is basically an alloy strengthened with molybdenum and containing enough chromium for moderate oxidation resistance. The carbide type is controlled by the silicon concentration.

2.3.2.3 Corrosion resistance of Hastelloy N

Several hundred thousand hours of corrosion experience with Hastelloy N and fluoride salts have been obtained in thermal convection^{1,2} and pumped systems.⁷ These experiments showed that the predominant corrosion mechanism in clean fluoride salts containing uranium is the selective leaching of chromium. Only 7% of the alloy is chromium and this must diffuse to the surface before it can be removed by the salt. DeVan measured the rate of chromium diffusion in Hastelloy N,⁸ and the measured diffusion coefficients were used to estimate the chromium profile after 30-year service at 650 and 700°C in salt sufficiently oxidizing to completely deplete the alloy surface of Cr. Even in this extreme situation, the depth of chromium removal was less than 10 mils.

The early work with Hastelloy N and other alloys revealed the importance of controlling impurities in the salt. Impurity fluorides such as FeF_2 , MoF_2 , and NiF_2 will react with Cr to form CrF_2 , a more stable fluoride. Water will react with the fluoride mixtures to form HF that will form fluorides with all the structural metals. Such impurities led to relatively high corrosion rates of even Hastelloy N in the early experiments. However, with pure salt mixtures, very low corrosion rates were obtained. The ultimate proof of this was the operation of the MSRE where the overall corrosion was quite low during almost four years at temperature.

The preceding discussion applied to the removal of material, but deposition is also of concern. As the salt circulates from hotter to cooler regions, the solubilities of the corrosion products in the salt decrease, and if concentrations are high enough, material may be deposited. This process is complex, depending upon chemical driving forces and factors such as geometry and flow conditions. Fortunately, the salts being

considered for an MSBR tend strongly to deposit material rather uniformly throughout the cold region and have a minimal tendency to plug heat-exchanger tubes and salt passages in cooler parts of the system.

2.3.2.4 Physical and mechanical properties of Hastelloy N

The physical and mechanical properties of Hastelloy N were evaluated rather extensively before the MSRE was constructed. These properties have been summarized previously.⁹ The strength of this alloy is quite good because of the 16% molybdenum. The property changes with time are small since the alloy does not form intermetallic compounds but only small amounts of fine carbides.

2.3.2.5 Experience with Hastelloy N in the MSRE

2.3.2.5.1 Fabrication

Although the power level of the MSRE was low, the system was complex and required the ability to carry out all of the basic fabrication steps.¹⁰ Many thousands of pounds of basic product forms were procured from three vendors. Some of the components were built by commercial vendors, but most of the fabrication was done in the AEC-Union Carbide shops at Oak Ridge and Paducah. Welding, brazing, and inspection procedures needed for constructing the reactor were developed. One of the final steps was to make use of the heaters on the vessel to postweld anneal the final vessel closure weld.

2.3.2.5.2 Operation

No difficulties related to materials were encountered during MSRE operation. The primary system was held above 500°C for 30,807 hours and was filled with fuel salt for 21,040 hours. The only failure involving Hastelloy N was through-wall cracking of a freeze valve coincident with final shutdown of the system.¹² This failure was due to fatigue from differential thermal expansion in a part that was constructed too rigidly.

2.3.2.5.3 Corrosion

Corrosion during the operation of the MSRE was followed both by analyzing the salts and examining surveillance specimens removed from the core. The primary corrosion product CrF_2 , remained below its solubility limits in the salt; so its concentration could be used as a measure of the amount of chromium being removed from the metal. The results of such analyses have been described in detail.¹² A simple summary is that the chromium removal was very small: the total amount accumulated in the

fuel salt was equivalent to that which would be removed from all metal surfaces to a depth of 0.4 mil; the amount appearing in the coolant salt was practically nil.

Surveillance samples located in the core of the MSRE were periodically removed for examination and testing. Samples of both standard and modified Hastelloy N were always in excellent physical condition with only a slight amount of discoloration,^{13,14,15,16} and visual metallographic examination failed to reveal any changes that were attributable to corrosion. (As discussed in detail later, a serious problem was revealed after examination of tensile specimens that were stressed to failure; however, the cause of the problem is not considered to be "corrosion.")

The chromium gradients in some of these samples were measured by the electronmicroprobe analyzer, and the worst case was a gradient that extended about 0.8 mil into the material.¹⁷ Standard metallographic¹⁷ (~100 magnification) examination of several tubes from the coldest part of the heat exchanger revealed only deposits of a few iron crystals.

The MSRE coolant circuit contained LiF-BeF₂ (66-34 mole %) at 550-650°C for about 26,000 hours. The chromium content of the coolant salt did not change measurably during this time, and no chromium depletion could be detected by metallographic methods.

Thus, the MSRE experience confirmed the basic compatibility of fuel salt, Hastelloy N, and graphite that had been indicated by many tests.

2.3.2.5.4 Radiation embrittlement

Many of the surveillance samples from the MSRE were subjected to mechanical property tests that confirmed the previous knowledge that Hastelloy N is embrittled by neutron irradiation.^{13,14,15,16} This embrittlement occurs only at elevated temperatures and is due to helium formation in the metal; it is quite universal among iron and nickel base alloys.¹⁸⁻³⁰ The degree of embrittlement in the MSRE was equivalent to that noted in samples irradiated in the ETR and ORR. Thus, the mechanical properties were not degraded differently when exposed to salt than when exposed only to inert gas.

Fracture strain was the property of most concern with respect to the MSRE. The fracture strains of some samples from the core were only 0.5% in creep tests at 1200°F, in contrast to strains of ≥10% for unirradiated samples. Surveillance specimens exposed alongside of the reactor vessel at lower flux had strains of only 2%.^{15,16} The control rod thimbles were the only metal in the core, and they were subjected to small compressive forces. The vessel was subjected to very small stresses. Consequently, the rather low strain limits were not exceeded and the system operated without failure from radiation damage.

The entire area of the design of components for high temperature service is receiving considerable attention. Although the strain limits have not been firmly established, it seems likely that local strains above those allowed by standard Hastelloy N must be accommodated.

2.3.2.5.5 Grain-boundary cracks

A second problem noted with Hastelloy N removed from the MSRE was that shallow intergranular cracks formed in surveillance samples and on all other surfaces in contact with the fuel.¹³⁻¹⁷ These cracks generally extended to depths of only about 5 mils, but some were as deep as 13 mils in parts removed from the pump bowl. Although recognizable in metallographic sections of some material removed from the MSRE, more were visible and they were opened much wider after being strained in the hot cell. Cracks found after straining material that had been exposed in the core were no more pervasive or deeper than those in the heat-exchanger tubes, which had been exposed to insignificant neutron flux. By controlled dissolution of several samples, a number of fission products were found within the material to a depth of several mils. This suggested that the cracking was caused by diffusion of fission products in the grain boundaries - particularly tellurium, which was found at the highest concentration.

2.3.3 Status of development

2.3.3.1 Generalized corrosion

Hastelloy N (both standard and modified) has been shown in the MSRE, other in-pile tests, and large number of out-of-pile loops to have excellent corrosion resistance in salts containing LiF, BeF₄, ThF₄, and UF₄.^{1,2,7,31} This extensive experience confirms the behavior that would be predicted from diffusion calculations. Titanium forms a stable fluoride, and the addition of this element to Hastelloy N could increase the corrosion rate. However, diffusion measurements have shown that Ti diffuses more slowly in Hastelloy N than Cr and that it would likely contribute very little to the corrosion rate. Several corrosion loops containing insert samples of Ti-modified Hastelloy N confirm that the modified alloy does not corrode more rapidly than standard Hastelloy N. In fact, the lower iron content (Table 2.1) causes the modified alloy to have a lower corrosion rate.

Corrosion studies with a proposed coolant salt, sodium fluoroborate, have been more limited.³²⁻³⁵ Four thermal convection loops and two pumped systems have been operated for a total test time of about 140,000 hr. This experience reveals that the fluoroborate salt absorbs moisture quite readily, with attendant generalized corrosion. On occasions when leaks developed, the corrosion rate has increased and then decreased as the impurities were exhausted. During these periods of high corrosion all components of the alloy were removed uniformly from the hot leg and

deposited in the cold leg. Crystals of Na_3CrF_6 and Na_3FeF_6 deposited in the cold regions as their solubilities were exceeded. Nevertheless, pumped loops in which the coolant salt is heated and cooled between 1270 and 795°F have been operated for several thousands of hours with corrosion rates of <0.1 mpy.

Screening experiments have shown that iron-base materials such as the austenitic stainless steels and nickel-base alloys containing more Cr than Hastelloy N have improved resistance to fission-product cracking. For this reason, they may be considered as alternate candidates for use in the primary circuit if Hastelloy N cannot be modified to obtain sufficient resistance.

The corrosion behavior of several other nickel-base alloys was investigated in screening tests in the aircraft propulsion program.^{1,2} The proposed service temperature was 1500°F and most of these alloys were not considered further because in tests at that temperature large amounts of chromium were removed, with formation of voids in the hot regions of test loops and deposition of chromium crystals in the cold regions. Inconel 600 received more study than any alloy besides Hastelloy N, and the evaluation program on it involved several thermal convection loops and 9 forced convection loops that operated for a total of 79,300 hr.⁷ Although the corrosion resistance of Inconel 600 was not as good as that of Hastelloy N, at MSBR temperatures the rates were sometimes low enough to be of interest. For example, one Inconel 600 loop operated at a peak temperature of 1250°F for 8801 hr with intergranular penetrations of 1.5 mils. This penetration is high by our current standards, but was only slightly higher than that observed for Hastelloy N tested in salt of comparable purity. Thus, it is likely that an alloy containing 15% chromium (e.g., Inconel 600) would have acceptable corrosion resistance at 1200°F or less.

The compatibility of iron-base alloys with fluoride salts has received relatively little attention because the thermodynamic data indicate that nickel-base alloys with a minimum chromium content will be more corrosion resistant than iron-base alloys. The initial screening tests on types 300 and 400 stainless steels indicated that these alloys were unsatisfactory.^{1,2} However, one type 304L stainless steel thermal convection loop containing a fuel salt has been in operation for over 9 years without plugging;³⁵ the corrosion rate at the peak temperature of 1270°F is about 1.5 mpy. It is quite likely that the corrosion rate could be reduced to an acceptable value by decreasing the temperature to 1200°F, but tests at higher velocities would be required to provide more conclusive information.

A most important consideration in the suitability of iron-base alloys is the possibility that, through some misoperation, the salt could become sufficiently oxidizing to corrode the iron. This process would not be diffusion controlled, and large amounts of material could be transferred quickly from the hotter regions to the cooler regions of the system. While this is also true for nickel, it can occur with iron

at less severe conditions. However, the oxidation state can be controlled closely enough for the salt to never become this oxidizing to either material.

Iron-base alloys are not compatible with sodium fluoroborate since iron seems to be attacked as readily as chromium. The use of duplex tubing in the primary heat exchangers would likely be required if iron base alloys were used for constructing the primary circuit.

2.3.3.2 Irradiation embrittlement

The peak fast fluence at the inside surface of the MSBR reactor vessel will be of the order of 10^{20} neutrons/cm², which is too low to cause detectable swelling and void formation in the metal.³⁶ However, the peak thermal fluence of 5×10^{21} neutrons/cm² is great enough to produce significant amounts of helium, about 5 ppm from residual ¹⁰B and possibly another 100 to 200 ppm by transmutations involving nickel.³⁷ In standard Hastelloy N the helium would reduce the grain boundary cohesion and increase the tendency for grain boundary fracture, with the result that the fracture stains at elevated temperatures become quite low.

The approach to combating embrittlement is to add elements such as titanium, hafnium, zirconium and niobium that promote the formation of finely dispersed MC type carbides.³⁸ These carbides produce numerous interfaces that trap the helium rather than allowing it to be swept into the grain boundaries.

All of the carbide-forming elements are beneficial in improving the fracture strain, but there are several practical reasons why titanium and niobium are more desirable. Zirconium has been found to cause weld metal cracking in concentrations as low as 0.05% and for this reason, would be a very undesirable alloying addition.³⁹ Hafnium causes weld metal cracking at concentrations of about 0.7%, but the greatest problem with using this element is its very high chemical reactivity. In small laboratory melts in which the metal only contacts a water-cooled copper mold, the hafnium is present as desirable finely dispersed carbides. In commercial melting practices where the melt contacts a refractory crucible, the hafnium is primarily present as a coarse compound. This likely occurs because hafnium is sufficiently reactive chemically to reduce the oxides and other compounds in the refractory crucible. The coarse compounds do not result in good mechanical properties after irradiation. We have found that niobium additions alone do not improve resistance to irradiation embrittlement, but they are beneficial when titanium is present.³⁸ However, both niobium and titanium form brittle Ni₃ (Ti, Nb) compounds and their total concentration must be limited. Since titanium seems to be the most effective single additive in improving the resistance to irradiation, attention has been concentrated on alloys which contain about 2% titanium.

The amount of titanium required for good resistance to neutron irradiation depends strongly upon the service temperature.³⁸ At 1200°F alloys with 0.5% titanium have fracture strains of above 4%, but at an irradiation temperature of 1400°F, 2% titanium is required to obtain the same properties. Direct transmission electron microscope observations have shown that this is due to the fine carbide becoming less stable, and more titanium being necessary for stabilization as the service temperature is increased.

Several 100-lb commercial melts containing 1.5 to 2.1% titanium were procured from three vendors and evaluated. The mechanical properties and weldability of the unirradiated melts are superior to those of standard Hastelloy N. The compatibility of titanium-containing alloys with fuel salt has been investigated using specimens of modified alloys in natural circulation loops, and some specimens were exposed in the MSRE core. Although the titanium is reactive with the salt, it diffuses less rapidly than the chromium and does not contribute detectably to the corrosion rate.⁴⁰ Hastelloy N modified by the addition of about 2% titanium has thus been found to be adequately resistant to radiation at 1400°F, to be weldable without unusual difficulty, and to be free of added corrosion problems. Commercial-scale production of this alloy must be demonstrated, but the alloy composition does not appear to be one that will present problems.

Exploratory irradiation studies have shown that Inconel 600 and all other nickel-base alloys are embrittled at elevated temperatures by thermal neutron irradiation.^{18,19,21,22,28-30} The fracture strains vary for different alloys, irradiation, and test conditions. However, the fracture strains will likely be too low for alloys such as Inconel 600 without closer controls on chemistry, grain size, and other factors.

The stainless steels are also embrittled by irradiation, but it is possible that the fracture strains under MSBR service conditions will be adequate.⁴¹ If not, significant improvements have been made in types 304 and 316 stainless steel by controlling the grain size or altering the composition (such as adding small amounts of Ti).⁴²

2.3.3.3 Intergranular cracking

As noted earlier, intergranular cracking was observed in the surveillance samples and several components from the MSRE.¹⁷ The most significant characteristics of the cracks are:

1. Cracks were formed on all surfaces exposed to fuel salt.
2. Irradiation of the metal did not seem to be a factor, since the cracks were equally severe in components that were irradiated and unirradiated.

3. Some cracks were visible in polished sections from some components (particularly the heat exchanger) when they were removed from service, but deformation at ambient temperature was required to make most visible.
4. The material removed from the MSRE had been heated and exposed to fission products for times ranging from 2500 to 25,000 hr. Although the frequency of cracks increased with time, the maximum depth did not increase detectably.

Similar intergranular cracks have not been produced by corrosion. To determine whether corrosion could be the cause, the salt in one fuel-salt loop was made quite oxidizing by adding FeF_2 . Selective intergranular attack occurred, but the attack was very shallow and the corroded grain boundaries did not open further during straining. The second, and most convincing evidence that corrosion (chromium depletion) did not cause the cracks came directly from examination of MSRE samples. Although chromium depletion could not be detected in samples from the heat exchanger and in a section of the control rod thimble that was under a spacer sleeve, these samples were cracked as severely as those (e.g., the bare control rod thimble in which chromium depletion was detectable). Thus, it seems unlikely that chromium depletion alone can account for the observed cracking.

The next possible mechanism considered was that one or several elements diffused into the material preferentially along the grain boundaries and degraded them in some way. The process responsible for the cracking could be (1) the formation of a compound that is very brittle, (2) formation of low-melting phases along the grain boundaries that become liquid at operating temperature, or (3) a change in composition along the grain boundaries so that they are still solid but very weak. The first and third mechanisms would require some deformation to form the cracks, but the second mechanism would not require strain, and samples could have cracks present before postoperation deformation. The results of a number of tests and data from the literature^{43,44} suggested strongly that the intergranular attack is caused by the inward diffusion of elements of the sulfur, selenium, tellurium family with tellurium having the most adverse effect, and subsequent studies were concentrated on tellurium. Since these elements all behave similarly, an understanding of how tellurium causes cracking should lead to an understanding of the behaviour of the other elements.

Numerous laboratory experiments were run that demonstrate very clearly that small amounts of tellurium will cause intergranular cracking in Hastelloy N. These experiments include: (1) the measurement of grain boundary and bulk diffusion coefficients of tellurium in Hastelloy N, type 304 stainless steel, and nickel; (2) exposure of numerous materials to electro- or vapor-plated tellurium with subsequent straining and metallographic examination; (3) tube burst specimens of Hastelloy N and type 304 stainless steel electroplated with tellurium and stressed in salt; (4) creep tests of Hastelloy N, type 304 stainless steel, nickel,

and Inconel 600 in inert gas-tellurium vapor environments; (5) strain cycle experiments of Hastelloy N electroplated with tellurium to determine crack propagation rates; and (6) mechanical property tests on alloys containing small amounts of fission products.

The diffusion rate of tellurium into Hastelloy N was measured. Samples with ^{127}Te deposited on the surface were annealed for 3000 hr at 650 and 760°C. At 650°C the penetration was so shallow that the lapping technique used did not give very reliable values, but accurate results were obtained at 760°C and the diffusion coefficient in the bulk material was 1.01×10^{-14} cm²/sec, about equivalent to that of chromium at 650°C. The penetration profiles also were used to obtain the product of the grain boundary width and the grain boundary diffusion coefficient, and measured quantities were then used with the Fisher model⁴⁵ to compute the grain boundary penetration. On this basis, the maximum penetration of tellurium in an MSBR at 760°C would be 8 mils in 30 years. The less accurate experimental values obtained at 650°C were used to estimate that tellurium should have penetrated the grain boundaries in the MSRE to a depth of 2 to 3 mils, and the penetration of an MSBR operating at 650°C for 30 yr should be about 4 mils. The relatively low sensitivity of the penetration depth to the time is due to the variation with time to the one-fourth power for grain boundary diffusion compared with the one-half power for bulk diffusion. These computed depths of penetration are quite acceptable, but several factors can alter the results, hence they cannot be taken quantitatively.

Little is known about the chemistry of tellurium, but most likely it is similar to that of sulfur. The basic problem with nickel alloys containing sulfur is due to a low melting nickel-sulfur eutectic that forms when sulfur segregates in the grain boundaries and causes these regions to be weak relative to the matrix. Alloying additions such as chromium raise the melting point of the eutectic and reduce the magnitude of the problem. Some proprietary work on superalloys shows that about 16% chromium is required to make a superalloy resist embrittlement by sulfur. Assuming parallel behavior of tellurium, its deleterious effects on Hastelloy N might be offset by the addition of chromium.

Additions of tellurium, selenium, and sulfur are often made to steels to obtain improved machinability but they cause embrittlement at high temperatures. Small cerium additions have been effective in reducing the embrittlement. Thus cerium additions to Hastelloy N may also be effective in making the tellurium innocuous.

Tellurium probably behaves in non-fissioning melts much as it does in a fissioning salt; hence, laboratory experiments can be used to answer many questions related to tellurium-induced intergranular attack. A large number of materials on which tellurium had been electrodeposited or vapor deposited were annealed at 650°C for 1000 hr. Straining these samples at room temperature resulted in intergranular cracks one grain deep for standard Hastelloy N and a number of other materials. A number of materials showed little or no intergranular attack, and those

which are of interest for MSR's are shown in Table 2.3.3.3.1. Of these, titanium-modified Hastelloy N may be sufficiently resistant to attack, and no attack has been observed for the remaining materials. It is believed that a satisfactory alloy can be obtained from one of the first three categories, and it is known that these materials will also have adequate resistance to neutron embrittlement and general corrosion.

If a higher chromium alloy were used (e.g., Inconel 600), it would be necessary to test its neutron embrittlement characteristics and to develop adequate resistance if this were not present. Neutron embrittlement in type 304 stainless steel containing 0.2% Ti is not a problem. Generalized corrosion could be a problem with both of the latter materials, and the reactor outlet temperature might have to be lowered from 1300°F to 1200°F in the case of stainless steel. The nominal composition of the material of greatest interest is shown in Table 2.3.3.3.2. The molybdenum and silicon contents have been decreased from those in standard Hastelloy N, and 2% Ti has been added to provide resistance to neutron embrittlement. The rare earths were added in low concentrations to provide increased resistance to intergranular attack by tellurium.

2.4 TASK GROUP 1.1 DETERMINATION OF ALLOY COMPOSITION

Tests will be carried out to determine basic information related to chemical reactions between Hastelloy N, tellurium, and salt. The reaction products will be identified and the rate constants associated with their formation will be measured. Various alloys will be irradiated to determine their resistance to irradiation embrittlement. An important variable in these studies will be the alloy composition. Emphasis will be placed on a modified Hastelloy N having a base composition of 12% Mo, 7% Cr, 0.05% C, balance Ni. Additions of titanium up to 2% and rare earth (e.g., Ce, La) up to 0.02% will be evaluated. The end result of this task should be the selection of an alloy with adequate resistance to irradiation embrittlement and intergranular cracking which is also compatible with the sodium fluoroborate coolant salt.

2.4.1 Objective

The objective of this task is to pinpoint the composition of modified Hastelloy N that meets the requirements set forth in Subsection 2.3.1.

2.4.2 Schedule

The schedule for work in Task Group 1.1 is shown in Table 2.4.2.

Table 2.3.3.3.1. Potential materials for MSBR primary circuit

Ti-Modified Hastelloy N (2% Ti)
Ti-RE-Modified Hastelloy N (2% Ti + 0.01 to 0.1% Ce of La)
Ti-Nb-Modified Hastelloy N (Ti + Nb, ~2% total)
Hastelloy or Inconel containing ~16% Cr
Type 304 stainless steel (1200°F reactor outlet)

Table 2.3.3.3.2. Nominal composition of Hastelloy N (%)

	Standard	Modified
Ni	Bal	Bal
Mo	16	12
Cr	7	7
Fe	4	0.5
Mn	0.5	0.2
Si	0.5	0.1
C	0.05	0.05
Ti	--	2
RE	--	0.01

Table 2.4.2. Schedule for work in Task Group 1.1 - Determination of alloy composition

	Fiscal year		
	1975	1976	1977
1.1.1 Procurement of test materials			
1.1.1.1 Small heats with rare earth additions			
1.1.1.2 10,000 lb heat containing 2% Ti			
1.1.1.3 Laboratory melts with various Ti-Nb concentrations			
1.1.2 Basic studies on interaction of Te with Hastelloy N			
1.1.2.1 Interaction of Hastelloy N with Te vapor			
1.1.2.2 Interaction of Hastelloy N with Te in fuel salt			
1.1.3 Effects of fission products on mechanical properties			
1.1.3.1 Creep tests			
1.1.3.2 Tube burst tests			
1.1.3.3 Strain cycle tests			
1.1.4 Thermal convection corrosion tests			
1.1.5 Forced convection corrosion tests			
1.1.5.1 FCL-2			
1.1.5.2 FCL-3			
1.1.5.3 FCL-4			
1.1.5.4 FCL-5			
1.1.6 In-reactor fuel capsule tests			
1.1.6.1 TeGen-1			
1.1.6.2 TeGen-2			
1.1.6.3 TeGen-3			
1.1.6.4 TeGen-4			
1.1.6.5 TeGen-5			
1.1.6.6 TeGen-6			

Table 2.4.2 (continued)

	Fiscal year		
	1975	1976	1977
1.1.7 Irradiation embrittlement of Hastelloy N			
1.1.7.1 ORR irradiation of tensile specimens			
1.1.7.2 Post irradiation creep tests			
1.1.7.3 Tube burst tests	—	—	
1.1.7.4 Control creep tests			
1.1.7.5 Characterization of microstructure			

2.4.3 Funding

Operating fund requirements for Task Group 1.1 are summarized in Table 2.4.3.1, and capital equipment requirements are summarized in Table 2.4.3.2.

2.4.4 Facilities

This task will require use of the following facilities:

Bldg. 2011 — This building will house the mechanical testing equipment (30 creep machines and strain cycle machines), data storage, research material storage, some Te-Hastelloy N compatibility work, and alloy annealing facilities.

Bldg. 4500S, Rm. T-40 — This laboratory will house the thermal convection loops (~12 loops).

Bldg. 9203-1 — The forced convection loops will be located on the operating floor of this building.

ORR — Two poolside facilities and associated control rooms will be used to irradiate mechanical property specimens of Hastelloy N and to irradiate fuel capsules.

Hot Cells — One cell will be used in Bldg. 3025 for postirradiation creep testing. Several other hot cells will be used for short periods of time for experiment disassembly, metallography, and various other experiments on irradiated materials.

Miscellaneous Labs in Bldg. 4500 — Several general purpose labs will be used for this work.

2.4.5 Task 1.1.1 Procurement of test materials

The test materials to be procured focus on the further evaluation of the effects of additions of titanium, rare earths, and niobium on the properties of Hastelloy N. The role of titanium in this alloy is reasonably well established, and a 10,000-lb heat is being procured to obtain experience on melting and fabrication procedures. The addition of rare earths or niobium in combination with titanium is aimed at obtaining increased resistance to intergranular cracking. Only small heats of these alloys will be prepared until the effects of these elements are better understood. If the results from the small melts are encouraging, commercial melts will be procured to further evaluate niobium and rare-earth additions.

Table 2.4.3.1. Operating fund requirements for Task Group 1.1 —
Determination of alloy composition (costs in 1000 dollars)

	Fiscal year		
	1975	1976	1977
1.1.1 Procurement of test materials			
1.1.1.1 Small heats with rare earth additions	10	10	
1.1.1.2 10,000 lb heat containing 2% Ti	15		
1.1.1.3 Laboratory melts with various Ti-Nb concentrations	5	10	
Subtotal 1.1.1	30	20	
1.1.2 Basic studies on interaction of Te with Hastelloy N			
1.1.2.1 Interaction of Hastelloy N with Te vapor	150	61	
1.1.2.2 Interaction of Hastelloy N with Te in fuel salt	254	200	
Subtotal 1.1.2	404	261	
1.1.3 Effects of fission products on mechanical properties			
1.1.3.1 Creep tests	125	125	
1.1.3.2 Tube burst tests	100	50	
1.1.3.3 Strain cycle tests	125	125	
Subtotal 1.1.3	350	300	
1.1.4 Thermal convection corrosion tests	100	125	
1.1.5 Forced convection corrosion tests			
1.1.5.1 FCL-2	90	60	
1.1.5.2 FCL-3	20	60	
1.1.5.3 FCL-4	5	35	
1.1.5.4 FCL-5		20	
Subtotal 1.1.5	115	175	
1.1.6 In-reactor fuel capsule tests			
1.1.6.1 TeGen-1	30		
1.1.6.2 TeGen-2	90		
1.1.6.3 TeGen-3	82		
1.1.6.4 TeGen-4		90	
1.1.6.5 TeGen-5		80	
1.1.6.6 TeGen-6		80	
Subtotal 1.1.6	202	250	

Table 2.4.3.1 (continued)

	Fiscal year		
	1975	1976	1977
1.1.7 Irradiation embrittlement of Hastelloy N			
1.1.7.1 ORR irradiation of tensile specimens	65	120	
1.1.7.2 Post irradiation creep tests	100	120	
1.1.7.3 Tube burst tests	70	80	
1.1.7.4 Control creep tests	100	80	
1.1.7.5 Characterization of microstructure	135	162	
Subtotal 1.1.7	470	562	
Total operating funds for Task Group 2.1	1671	1693	

Table 2.4.3.2. Capital equipment fund requirements for Task Group 1.1 — Determination of alloy composition (costs in 1000 dollars)

	Fiscal year		
	1975	1976	1977
1.1.2 Basic tellurium interaction studies	10	93	
1.1.3 Effects of fission products on mechanical properties			
1.1.3.1 Creep tests	35	40	
1.1.3.3 Strain cycle tests	30	30	
1.1.4 Thermal convection tests	45	40	
1.1.5 Forced circulation loops	5	25	
1.1.5.2 FCL-3	300		
1.1.5.3 FCL-4	300		
1.1.5.4 FCL-5		330	
1.1.6 In-reactor capsule tests	10	5	
Total capital equipment funds for Task Group 1.1	735	563	

2:4.5.1 Subtask 1.1.1.1 Small commercial heats with rare-earth additions

Four 125-lb commercial heats will be procured for evaluation. These heats will consist of 0.01 to 0.02% additions of Ce, La, and Misch metal (primarily Ce and La) to a modified Hastelloy N base containing 2% Ti. The alloys will be prepared by vacuum induction melting followed by electroslog remelting and rolling to 1/2-in.-thick plate. The weldability of the four melts will be determined, and the material will be used in all portions of Task Group 1.1.

2.4.5.2 Subtask 1.1.1.2 10,000-lb commercial melt containing 2% Ti

A 10,000-lb heat of modified Hastelloy N containing 2% Ti will be procured in order to obtain experience with the production of a commercial heat of material which is believed to be close in composition to a number of acceptable alloys. This alloy composition has been noted through experience with several 100-lb heats to have excellent resistance to irradiation embrittlement and better resistance to intergranular fission product cracking than standard Hastelloy N. The large heat will be fabricated into several product forms and will be utilized in many tasks in Task Group 1.1.

2.4.5.3 Subtask 1.1.1.3 Laboratory melts having various Nb-Ti concentrations

Niobium additions improve the resistance of Hastelloy N to intergranular cracking, but have very little effect on resistance to irradiation embrittlement. The combined use of titanium for affording resistance to irradiation embrittlement and niobium for increasing the resistance to tellurium intergranular attack will be explored. Niobium and titanium are additive in inducing the formation of brittle gamma-prime in the alloy, hence they must be added sparingly. About twenty laboratory melts, each weighing about 2 lb, will be made with various additions of titanium and niobium. These alloys will be evaluated in other tasks of Task Group 1.1.

2.4.6 Task 1.1.2 Basic studies on interaction of tellurium with Hastelloy N

Since actual reactor operating conditions represent an extrapolation of experimental observations, it is imperative that reactions be understood rather than their rates being measured over a relatively short time period. This task is directed toward understanding the interactions of tellurium, Hastelloy N, and salt in sufficient detail to define the phenomena which lead to attack in standard Hastelloy N and to determine how attack is prevented in potential materials of construction.

2.4.6.1 Subtask 1.1.2.1 Interaction of Hastelloy N with tellurium vapor

Tellurium will be present as the metal dimer, Te_2 , and in smaller quantities as the monomer, Te , and/or in a reduced state under the reducing conditions that will be present in the MSBR primary circuit. Thus, studies where Hastelloy N is exposed to small amounts of tellurium vapor are believed to simulate reactor operating conditions closely enough to be valuable. Hastelloy N (modified and standard) will be exposed to tellurium vapor and the reacted metal will be used to identify reaction products, evaluate effects on mechanical properties, and determine reaction kinetics. Variables studied will be tellurium concentration, temperature, time, and alloy composition. Auger spectroscopy, electron-microscopy, and x-ray diffraction will be used to identify reaction products. Some samples will be deformed at ambient temperature after exposure to tellurium. Samples will also be sectioned and viewed metallographically to determine the extent of intergranular cracking.

2.4.6.2 Subtask 1.1.2.2 Interaction of Hastelloy N with tellurium in fuel salt

The presence of salt is not likely to influence the interaction of Hastelloy N and tellurium, but experiments are required to show that this is the case. The principal source of compatibility samples will be mechanical property test samples from Task 1.1.3 that will have been exposed to salt which contains tellurium under well-defined conditions. The reaction products will be identified by Auger and x-ray spectroscopy. The extent of penetration of tellurium into the material will be determined by metallography.

2.4.7 Task 1.1.3 Effects of fission products on mechanical properties

Review of the available information of the effects of fission product elements on the mechanical properties of Hastelloy N indicates that tellurium produces by far the largest effect; however, some work will be continued on other elements to ensure that they do not also have adverse effects which could be important under some conditions. Several alloys have been prepared which contain small amounts of fission product elements, but most of the tests will involve undoped alloys that will be stressed while also being exposed to a tellurium-containing environment.

2.4.7.1 Subtask 1.1.3.1 Creep tests

Small heats of Hastelloy N containing 0.01% Se, Te, Sr, Tc, Ru, Sn, and Sb have been prepared previously. These materials will be tested under creep conditions to determine how these elements influence the tendency for crack formation during creep tests.

Creep tests of standard and modified Hastelloy N specimens will be run in salt-tellurium environments to determine how the tendency to form intergranular cracks varies with test conditions and metal composition. Effects of tellurium on creep behavior will also be evaluated. About 6 creep machines with salt chambers will be used in this work.

2.4.7.2 Subtask 1.1.3.2 Tube burst tests

Tube burst samples of standard and modified Hastelloy N will be run in a salt-tellurium environment. The tests will show the influence of tellurium on the rupture life of a material, and post-test examination will reveal the propensity for intergranular cracking. Variables studied will include specimen composition, test temperature, stress, and tellurium concentration. Twelve tube burst test positions will be in use continuously during work on this subtask.

2.4.7.3 Subtask 1.1.3.3 Strain cycle tests

These tests will impose alternating strains on a tubular sample while the outside surface of the sample is exposed to salt containing tellurium. This condition will be similar to that experienced by a heat exchanger tube being exposed to temperature transients. The time required for cracks to propagate through the tube wall will be determined as a function of alloy composition, concentration of tellurium, strain limits, and temperature. Five strain cycle machines will be used for this work.

2.4.8 Task 1.1.4 Thermal convection corrosion tests

Thermal convection loops will be operated to study the corrosion of modified Hastelloy N in fuel salt. At least two loops will be constructed of standard Hastelloy N, and small coupons of the modified alloys will be inserted in the loop for corrosion measurements. When tubing becomes available from the large 2% Ti-modified heat, an entire loop will be fabricated from this material. These loops will be equipped with electrochemical probes for measuring the U^{3+}/U^{4+} ratio and the concentrations of Fe, Cr, and Ni in the salt. Loops of austenitic stainless steel and Inconel 601 will be operated to determine the corrosion rates for materials having chromium concentrations above that of Hastelloy N. At least one Hastelloy N loop containing fuel salt will be used to determine the behavior of tellurium in a flowing system having a temperature gradient. Two Hastelloy N loops will be used to study the compatibility of Hastelloy N with the coolant salt. Insert samples of modified Hastelloy N will be exposed in this loop.

2.4.9 Task 1.1.5 Forced convection corrosion tests

Thermal convection loops are a relatively inexpensive method for determining corrosion behavior. However, the salt flow velocity in a thermal convection loop is only a few feet per minute as compared with velocities up to 20 ft per second that will be present in an MSBR. These higher velocities can increase the corrosion rate markedly over that observed in thermal convection loops at the lower velocities. Thus, some corrosion testing must be done in pumped systems at realistic flow rates. A versatile forced convection loop facility of near-standard design has been developed for material tests of this type. Work in forced convection facilities associated with this task (designated FCL-2, -3, -4, and -5) is discussed in more detail in the following sections.

2.4.9.1 Subtask 1.1.5.1 FCL-2

Portions of this facility which contact molten salt were constructed of standard Hastelloy N and the facility was operated for 7,000 hours with the sodium fluoroborate coolant salt. The loop was modified in late FY 1974 to allow circulation of fuel salt. This loop, designed specifically for materials testing, has a special pump designed to give variable pumping speeds. Test samples are located at three locations which can be operated at different temperatures. The samples can be removed by stopping the pump and melting a freeze valve at each location. The flow passage geometries are such that the surface velocities at the test coupons vary from 10 to 20 fps.

This loop will be used primarily for studying tellurium transport in a flowing system having a temperature gradient. Two objectives that must be accomplished before the loop can be operated as desired are (a) development of on-line analytical technique to determine the U^{3+}/U^{4+} ratio and tellurium-ion concentration in MSBR fuel salt (see Subtask 5.1.1.1), and (b) measurement of the base-line corrosion rate of Hastelloy N under the conditions to be used for the tellurium transport studies. Development work in both of these areas is in progress, and tellurium will be added to the system toward the end of FY 1975.

2.4.9.2 Subtask 1.1.5.2 FCL-3

This facility will be of the same basic design as FCL-2, but some design improvements will be made. All parts of the facility which contact salt will be fabricated from the 10,000-lb heat of 2% Ti-modified Hastelloy N. This facility will be used primarily to study the corrosion characteristics of the modified alloy in fuel salt. Work will begin on the facility early in FY 1975 and the system should be in operation before mid FY 1976.

2.4.9.3 Subtask 1.1.5.3 FCL-4

The design of this facility will be the same as for FCL-3. Portions of the facility that contact salt will be constructed of 2% Ti-modified Hastelloy N. The facility will be operated with fuel salt, primarily for study of tellurium transport in a flowing system having a temperature differential. This loop will be in operation by mid FY 1976.

2.4.9.4 Subtask 1.1.5.4 FCL-5

This facility will be constructed of 2% Ti-modified Hastelloy N and will contain coolant salt. The design will be quite similar to that of FCL-3 and -4, but will incorporate some changes due to the different physical properties of the fuel and coolant salts. The primary objective of this facility will be to determine the corrosion rate of the modified alloy in coolant salt. The facility will be equipped with on-line instrumentation to chemically characterize the salt at all times. This loop will be in operation by the end of FY 1976.

2.4.10 Task 1.1.6 In-reactor fueled capsule tests

Experiments have shown that intergranular cracking quite similar to that noted in the MSRE can be produced in the laboratory by exposure of standard Hastelloy N to small amounts of tellurium. Thus, laboratory experiments can be used as screening tests, but some in-reactor fueled tests will be necessary as proof tests. Small ($\sqrt{1/2}$ in. diam) tubes will be partially filled with fuel salt and irradiated in the ORR. The fissile content and irradiation time will be chosen to produce the desired amounts of fission products and alloy exposure interval. After irradiation, the fuel pins will be sectioned and some portions will be deformed to open intergranular cracks, while other strained and unstrained sections will be viewed metallographically to determine whether cracks were formed. Samples will be examined from both the liquid and vapor portions of the fuel tubes. In-reactor fueled capsule tests associated with this task (designated TeGen-1, -2, -3, -4, -5, and -6) are discussed in greater detail in the following sections.

2.4.10.1 Subtask 1.1.6.1 TeGen-1

In-reactor capsule TeGen-1 will be irradiated for 1 cycle ($\sqrt{1100}$ hr) in the ORR poolside facility at 700°C. The ^{233}U fuel loading was chosen such that the amount of tellurium which will be produced is equivalent to that produced in the MSRE during its entire operation. The fuel pin materials are standard Hastelloy N, type 304 stainless steel, and Inconel 601.

2.4.10.2 Subtask 1.1.6.2 TeGen-2

The design of capsule TeGen-2 will likely be the same as for TeGen-1. The fuel pins will be made of the Ti-modified alloys containing rare-earth additions as described in Subtask 1.1.1.1. The fuel pin design will be modified to incorporate small sheet samples for Auger spectroscopy. The experiment will run for 1 cycle (1100 hr) in the ORR.

2.4.10.3 Subtask 1.1.6.3 TeGen-3

The design of capsule TeGen-3 will likely be the same as that for TeGen-2. It will contain samples from the large 10,000-lb 2% Ti-modified heat. The exposure time will be two cycles (~2200 hr).

2.4.10.4 Subtask 1.1.6.4 TeGen-4

The purpose of this experiment will be to evaluate the cracking tendencies of modified compositions of Hastelloy N under different conditions. The design will be similar to TeGen-2, and the operating time will be 6 cycles (~6600 hr). The most attractive alloys available will be included in this experiment, and its purpose will be to evaluate the resistance of these materials to intergranular cracking over long periods of time.

2.4.10.5 Subtask 1.1.6.5 TeGen-5

The purpose of this experiment will be to evaluate the cracking tendencies of modified compositions of Hastelloy N under different conditions. The design will be similar to TeGen-2, and the materials and operating conditions will be selected on the basis of results from the development program.

2.4.10.6 Subtask 1.1.6.6 TeGen-6

The purpose of this experiment will be to evaluate the cracking tendencies of modified compositions of Hastelloy N under different conditions. The design will be similar to TeGen-2, and the materials and operating conditions will be selected on the basis of results from the development program.

2.4.11 Task 1.1.7 Irradiation embrittlement of Hastelloy N

Exposure for 1 cycle (1100 hr) in the poolside facility of the ORR is sufficient to transmute about half of the ^{10}B normally present in Hastelloy N to He. This is adequate exposure for evaluation relative to performance in an MSBR. Specimens suitable for tensile and creep tests will be irradiated at controlled temperatures after which they

will be removed from the irradiation capsule and subjected to post-irradiation creep tests. Creep data will be recorded in a manner such that adequate information will be available to assess the effects of irradiation on creep behavior, the stress-rupture behavior, and the fracture strain. Creep tests will also be run on unirradiated specimens. These tests will allow one to distinguish the effects of thermal treatment history and irradiation.

Some tube burst specimens will be run in which the specimens are irradiated and stressed simultaneously. The time to rupture will be measured directly from the test, and the rupture strain will be determined from postirradiation measurements.

Microstructure is very important in determining the mechanical properties of modified Hastelloy N, particularly in the irradiated condition. The microstructure will be characterized by several electron optic techniques. Facilities exist for the examination of both unirradiated and irradiated samples.

2.4.11.1 Subtask 1.1.7.1 ORR irradiation of tensile specimens

The various heats of modified Hastelloy N will be irradiated in the ORR to study their embrittlement during thermal neutron irradiation via helium formation resulting from the transmutation of ^{10}B and nickel. The experiments will normally be operated for 1 cycle to a peak thermal fluence of 3×10^{20} neutrons/cm². Irradiation temperature is an important variable and will be varied from 1050 to 1400°F. The current design for this experiment consists of 32 individually-heated positions, each containing 2 or 3 specimens. About six experiments of this type will be run in this subtask.

2.4.11.2 Subtask 1.1.7.2 Post irradiation creep tests

The samples irradiated in Subtask 1.1.7.1 will be creep tested to determine the influence of irradiation on the mechanical properties. The samples will be quite radioactive and these tests will be performed using creep machines in the hot cells. Twelve machines currently exist for this purpose. During these tests, stress, time, strain, and temperature will be recorded. The data will be reduced analytically to strain-time plots and various data correlations will be developed as required. About 500 tests of this type will be run.

2.4.11.3 Subtask 1.1.7.3 Tube burst tests

The tensile specimens tested in Subtask 1.1.7.1 will be irradiated without an applied stress and then subjected to post-irradiation testing. The work in this subtask involves tube burst tests which will be operated such that they are stressed and irradiated simultaneously. Although postirradiation tests are adequate for most purposes, some stressed

in-reactor tests are needed. The specimens are pressurized internally to provide the stress. The time to rupture is determined directly during the test, and the fracture strain is measured after the experiment is completed.

Tubing made from the 10,000-lb 2% Ti-modified heat will be available late in FY 1975, and this material will be used for this work. Some tubular material from other heats will be fabricated and one in-reactor tube-burst experiment will be carried out.

2.4.11.4 Subtask 1.1.7.4 Control creep tests

Irradiation experiments subject specimens to neutron irradiation as well as a period of thermal annealing. Each process can produce changes in the mechanical properties, hence the effects must be separated in order to evaluate the importance of each. The thermal annealing is approximated by annealing unirradiated specimens at times and temperatures equivalent to those encountered by specimens during irradiation. These specimens will be creep tested and the results compared with those for the irradiated samples. About 14 creep frames will be used for these tests.

2.4.11.5 Subtask 1.1.7.5 Characterization of microstructure

The development of a modified Hastelloy N with improved resistance to irradiation is based on developing a specific type of microstructure, and continued study of microstructures is a very important part of this program. Several analytical tools are used to characterize microstructures including transmission electron microscopy, extraction replication, x-ray and electron diffraction, electron microprobe analysis, and optical metallography. Samples will be studied before and after irradiation and after long periods of thermal exposure. The objective will be to obtain an in-depth correlation of microstructure and mechanical behavior. Variations from heat-to-heat will be correlated with chemical and process variables.

2.5 TASK GROUP 1.2 PROCUREMENT OF COMMERCIAL HEATS

After an acceptable composition for modified Hastelloy N has been determined by the work in Task Group 1.1, at least four large commercial heats (~10,000-lb) will be procured for evaluation. The specifications written for the procurement of this material will form the basis for future procurement. Orders for the four heats will be placed with at least two vendors by competitive bidding. The material will be obtained in product forms typically used in reactor construction. These materials will be carefully catalogued and utilized extensively in Task Group 1.3.

2.5.1 Objective

The objective of this task is to obtain four large commercial heats of the reference composition from two or more vendors for evaluation.

2.5.2 Schedule

The schedule for work on procurement of commercial heats is shown in Table 2.5.2.

2.5.3 Funding

Operating fund requirements for Task Group 1.2 are shown in Table 2.5.3. Capital equipment funds in the amount of \$10,000 will be required in FY 1977 for storage facilities to be used in Task 1.2.4, Receipt and Cataloging of Materials.

2.5.4 Task 1.2.1 Specifications

The composition of the reference material will be fixed on the basis of information developed in Task Group 1.1. Specifications will be written that cover the allowable ranges for the important elements. These specifications will also cover melting practice and quality control procedures for each product that will be produced.

2.5.5 Task 1.2.2 Bidding and vendor selection

The specifications will be submitted to several potential vendors for consideration. Their respective quotations and their abilities to satisfactorily prepare the materials will be considered, and purchase orders will be placed with two or more vendors if possible.

2.5.6 Task 1.2.3 Surveillance of fabrication

Production of the four heats of material should develop adequate background information concerning the fabricability of this alloy. Fabrication experience will be followed with each vendor and documented in order that this information will be available to the MSR Program.

2.5.7 Task 1.2.4 Receipt and cataloging of material

The various product forms from the four commercial heats will be catalogued and made available for Task Group 1.3. The cataloging system will be established so that all available processing information is identified with the various product forms.

Table 2.5.2. Schedule for work in Task Group 1.2 - Procurement of commercial heats

	Fiscal year			
	1975	1976	1977	1978
1.2.1 Specifications			—	
1.2.2 Bidding and vendor selection			—	
1.2.3 Surveillance of fabrication			—	
1.2.4 Receipt and cataloging of material			—	

Table 2.5.3. Summary of operating funds for Task Group 1.2 - Procurement of commercial heats (costs in 1000 dollars)

	Fiscal year			
	1975	1976	1977	1978
1.2.1 Specifications			10	
1.2.2 Bidding and vendor selection			5	
1.2.3 Surveillance of fabrication			5	
1.2.4 Receipt and cataloging of material			380	
Total operating funds for Task Group 1.2			400	

2.6 TASK GROUP 1.3 EVALUATION OF COMMERCIAL HEATS

The four large heats will be evaluated with respect to several properties including weldability, mechanical properties, compatibility with salt containing fission products, and physical properties. These tests will confirm the desirability of the composition selected and will provide sufficient data for design of MSBR systems and components. Tests of at least 10,000 hr duration will be required for design purposes. The quality of testing will be maintained at a high level to provide information with the precision necessary for design.

2.6.1 Objective

The objective of this task is to determine the mechanical and physical properties of the four reference heats and to demonstrate that the properties observed in small heats can be reproduced in commercial heats. Particular emphasis will be placed on evaluating the resistance of the commercial heats to neutron embrittlement and tellurium-induced intergranular cracking.

2.6.2 Schedule

The schedule for work in Task Group 1.3, Evaluation of Commercial Heats, is shown in Table 2.6.2.

2.6.3 Funding

Operating fund requirements for Task Group 1.3 are given in Table 2.6.3.1, and capital equipment fund requirements are given in Table 2.6.3.2. GPP funds in the amount of \$300,000 will be required in FY 1976 for modification of the Mechanical Property Test Laboratory.

2.6.4 Facilities

The facilities described in Subsection 2.4.4 will be used for this task group; however, additional mechanical property test facilities will be required. These facilities will be obtained through the purchase and construction of additional equipment and through subcontracts.

2.6.5 Task 1.3.1 Weldability

Test welds will be made in many of the products from the four large heats. Structural welds are usually made under conditions of high restraint, hence test welds will be made in which the two test plates to be joined together are each welded to a steel plate. This will require that the weld metal deform to accommodate the dimensional changes resulting from

Table 2.6.2. Schedule for work in Task Group 1.3 - Evaluation of commercial heats

	Fiscal year				
	1975	1976	1977	1978	1979
1.3.1 Weldability		_____			
1.3.2 Mechanical property tests					
1.3.2.1 Short-time tensile tests		_____			
1.3.2.2 Fatigue tests			_____		
1.3.2.3 Long-term creep			_____		
1.3.2.4 Special tests			_____		
1.3.2.5 Irradiation damage			_____		
1.3.3 Physical property measurements					
1.3.3.1 Thermal expansion			_____		
1.3.3.2 Thermal conductivity			_____		
1.3.3.3 Electrical conductivity				_____	
1.3.4 Thermal convection corrosion tests		_____			
1.3.5 Forced convection corrosion tests					
1.3.5.1 FCL-6			_____		
1.3.5.2 FCL-7			_____		
1.3.5.3 FCL-8				_____	
1.3.5.4 FCL-9				_____	
1.3.6 In reactor fuel capsule tests			_____		

Table 2.6.3.1. Operating cost summary for Task Group 1.3 -- Evaluation of commercial heats (costs in 1000 dollars)

	Fiscal year				
	1975	1976	1977	1978	1979
1.3.1 Weldability			50	75	
1.3.2 Mechanical property tests					
1.3.2.1 Short-term tensile tests		10	25	25	
1.3.2.2 Fatigue tests		150	275	325	
1.3.2.3 Long-term creep		125	350	375	
1.3.2.4 Special tests		147	212	297	
1.3.2.5 Irradiation damage					
Subtotal 1.3.2		432	862	1022	
1.3.3 Physical property measurements					
1.3.3.1 Thermal expansion		15	15	5	
1.3.3.2 Thermal conductivity		10	20	10	
1.3.3.3 Electrical conductivity			15	10	
Subtotal 1.3.3		25	50	25	
1.3.4 Thermal convection corrosion tests			200	250	
1.3.5 Forced convection corrosion tests					
1.3.5.1 FCL-6			100	75	
1.3.5.2 FCL-7			75	75	
1.3.5.3 FCL-8			25	75	
1.3.5.4 FCL-9				25	
Subtotal 1.3.5			200	250	
1.3.6 In-reactor fuel capsule tests			350	425	
Total operating funds for Task Group 2.3		457	1712	2047	

Table 2.6.3.2. Capital equipment fund requirements for Task Group 1.3 -
Evaluation of commercial heats (costs in 1000 dollars)

	Fiscal year				
	1975	1976	1977	1978	1979
1.3.1 Weldability			50		
1.3.2 Mechanical property tests					
1.3.2.1 Short-time tensile tests		25			
1.3.2.2 Fatigue tests		75	75		
1.3.2.3 Long-term creep		50	75	50	
1.3.2.4 Special tests		40	350	100	
1.3.2.5 Irradiation damage		10	200	10	
Subtotal 1.3.2		200	700	160	
1.3.3 Physical property measurements					
1.3.3.1 Thermal expansion		5			
1.3.3.2 Thermal conductivity		5			
1.3.3.3 Electrical conductivity			5		
Subtotal 1.3.3		10	5		
1.3.4 Thermal convection tests		27	75	25	
1.3.5 Forced convection loops					
1.3.5.1 FCL-6			80		
1.3.5.2 FCL-7			80		
1.3.5.3 FCL-8			80		
1.3.5.4 FCL-9				80	
Subtotal 1.3.5			240	80	
1.3.6 In-reactor fuel capsules		100	25	25	
Total capital equipment funds for Task Group 1.3		337	1095	290	

differential heating and cooling. The as-welded plates will be examined by dye penetrant and x-ray techniques. Bead samples will be cut from the test welds for bending and evaluation by ASME, Section VIII guidelines. Welding procedures will be developed which optimize the ease of welding and the mechanical properties of the weld.

It is likely that some postweld heat treatment will be needed to reduce residual stresses. Welded samples will be subjected to various postweld anneals and tested to determine the most desirable postweld heat treatment. Welded samples will also be irradiated and subjected to post-irradiation creep tests (Subtask 1.3.2.4). The results from unirradiated and irradiated samples will be used to determine the postweld anneal to be used in fabrication.

Weld samples will be subjected to sufficient mechanical property tests to develop basic data for design purposes. Information such as short-term stress-strain behavior, creep behavior, stress-rupture data, and strain to failure will be determined.

2.6.6 Task 1.3.2 Mechanical property tests

The mechanical property tests in this task will provide the data required for design purposes. The basic types of tests required will be short-term tensile, creep, fatigue, some special tests, and some tests of all types on irradiated samples. The test techniques must be advanced somewhat over those used in Task Group 2.1 in order to obtain the required degree of precision. Tests will be run on several products from all four heats to establish scatter bands.

2.6.6.1 Subtask 1.3.2.1 Short-term tensile tests

Time-independent stress intensities are based on short-term tensile tests. These tests will be run at several controlled strain rates and will cover the temperature range of 75 to 1500°F. Tests will be run on many product forms of all four heats. Samples will be annealed for various lengths of time and tensile tested to evaluate property changes. The test matrices for the four heats will include about 500 tests.

2.6.6.2 Subtask 1.3.2.2 Fatigue tests

Fatigue tests will be run at several strain ranges and the time to failure measured. The strain ranges and the temperatures studied will be similar to those anticipated in service. Fatigue properties are quite sensitive to surface conditions, hence the tests will be carried out in a salt environment of known composition. Some tests will be run in salt containing tellurium. These tests will cover the temperature range of 75 to 1500°F and strain ranges of 0.05 to 1% per cycle.

2.6.6.3 Subtask 1.3.2.3 Long-term creep

Creep tests of at least 10,000-hr duration will be required for the design of a test reactor. These tests must be very precise so that they accurately describe the strain-time behavior. The temperature range of concern for time-dependent properties is about 1000 to 1400°F. Many of the tests will be carried out in salt-fission product environments, and others will be run in air. Some samples will be annealed prior to creep testing to determine the influence of annealing on the creep behavior.

2.6.6.4 Subtask 1.3.2.4 Special tests

Several types of specialized tests will be necessary to characterize the mechanical behavior of material from the four large heats. One such type of testing will be combined creep and fatigue tests to develop a method of summing life fractions to predict failure. Multiaxial stresses pose another problem. Analytical methods exist for predicting behavior under multiaxial stresses on the basis of uniaxial test data. However, some testing must be done to confirm that these methods will apply to modified Hastelloy N.

2.6.6.5 Subtask 1.3.2.5 Irradiation damage

Samples of the four heats will be irradiated in the ORR to thermal fluences of about 3×10^{20} neutrons/cm² and at temperatures of 1000 to 1400°F. The metal conditions will include as-received, solution annealed, welded, and welded and stress-relieved. Most of the samples will be irradiated in the unstressed condition and subjected to post-irradiation creep testing. These tests are necessary for determining the creep behavior and measuring the rupture time and strain. About 8 ORR experiments will be completed, each containing about 100 samples. These samples will be subjected to postirradiation short-term tensile and creep tests.

Some in-reactor tube burst experiments will be operated in which tubular samples will be stressed and irradiated simultaneously. The time to failure will be measured during irradiation and the creep strain determined by postirradiation measurements. About 4 experiments of this type will be carried out.

2.6.7 Task 1.3.3 Physical property measurements

The physical properties of most importance in design are the elastic constants, thermal expansion, thermal conductivity, and electrical conductivity. These properties have been measured for standard Hastelloy N, but may be somewhat different for modified Hastelloy N. Physical measurements will be carried out for the modified alloy in order to provide the data required for design purposes.

2.6.7.1 Subtask 1.3.3.1 Thermal expansion

Thermal expansion is a very important design parameter. Dimensional changes which occur as a result of temperature changes often lead to stresses. Accurate thermal expansion data must be available on the modified alloy so that these stresses can be accurately predicted. Measurements will be made on several products from all four large heats over the temperature range of 75 to 1800°F. Particular note will be made of heat-to-heat variations and of anisotropy in the various products.

2.6.7.2 Subtask 1.3.3.2 Thermal conductivity

Thermal conductivity is a necessary parameter for design purposes. This property will be measured on all four heats over the temperature range of 75 to 1800°F. Measurements will be made on welds and base metal.

2.6.7.3 Subtask 1.3.3.3 Electrical conductivity

Electrical conductivity is a very basic physical property. It will be measured on all four heats over the temperature range of 75 to 1800°F.

2.6.8 Task 1.3.4 Thermal convection corrosion tests

Thermal convection loops will be fabricated using material from each of the four heats. The loops will be used to circulate fuel and coolant salts and will operate over the temperature range of 1000 to 1400°F. Electrochemical probes will be installed in each loop to measure the oxidation state and the concentrations of corrosion products. Removable samples will be placed in each loop and removed periodically for weighing and visual examination.

2.6.9 Task 1.3.5 Forced convection corrosion tests

Thermal convection loops are a relatively inexpensive method of determining corrosion behavior. However, the salt flow velocity in a thermal convection loop is only a few feet per minute as compared with velocities up to 20 ft per second in an MSBR. These higher velocities can increase the corrosion rate markedly over that observed in thermal convection loops at the lower velocities. Thus, some corrosion testing must be done in pumped systems at realistic flow rates. A versatile forced convection loop facility of near standard design has been developed for material tests of this type. The test facilities developed for loops FCL-2, -3, -4, and -5 will be modified by refabricating all parts that contact the salt from the new modified materials. Work in forced convection facilities associated with this task (designated FCL-6, -7, -8, and -9) is discussed in more detail in the following sections.

2.6.9.1 Subtask 1.3.5.1 FCL-6

The portions of this facility which contact salt will be fabricated from one of the commercial heats of modified Hastelloy N. The facility will be operated with fuel salt between the temperature limits of 1050 and 1300°F. The facility will be equipped with electrochemical probes for measuring the U^{3+}/U^{4+} ratio, and will have provisions for removable samples.

2.6.9.2 Subtask 1.3.5.2 FCL-7

The portions of this facility which contact salt will be fabricated from a different commercial heat of modified Hastelloy N from that used in Subtask 1.3.5.1. The facility will be operated with fuel salt over the temperature range of 1050 to 1300°F. After operating for about 6 months to establish a base-line corrosion rate, tellurium will be added to the salt, and subsequent operation will be concerned with the behavior of this element. The facility will be equipped with electrochemical probes for measuring the U(III)/U(IV) ratio and the tellurium ion concentration. The facility will have provisions for removable samples.

2.6.9.3 Subtask 1.3.5.3 FCL-8

The portions of this facility which contact salt will be fabricated from the heat of modified Hastelloy N used to construct the facility for Subtask 1.3.5.1. The facility will be used to circulate coolant salt over the temperature range of 1000 to 1300°F. Electrochemical probes will be installed to measure the oxidation state and the concentrations of impurities. The facility will have provisions for removable samples.

2.6.9.4 Subtask 1.3.5.4 FCL-9

The portions of this facility which contact salt will be fabricated from the heat of modified Hastelloy N used to construct the facility for Subtask 1.3.5.1. The facility will be used to circulate coolant salt over the temperature range of 1000 to 1300°F. Electrochemical probes will be installed to measure the oxidation state and the concentrations of impurities. The facility will have provisions for removable samples.

2.6.10 Task 1.3.6 In-reactor fueled capsule tests

In-reactor fueled capsule tests will be run to demonstrate the compatibility of the four heats of modified Hastelloy N with fissioning fuel salt. The capsules will contain small tubes ($\sim 1/2$ in. diam) filled with well-characterized fuel salt. The tests will be operated for periods ranging from 1 ORR cycle (6 weeks) to 1 year. The concentrations of fissile material and the irradiation periods will be chosen so as to produce quantities of fission products equal to those that would be

produced per unit area of metal surface in a commercial MSBR. The pins will be examined after irradiation to determine the extent of intergranular cracking if any. Pieces of the tubes will be deformed after irradiation to determine whether cracks form under these severe conditions. About 6 experiments, each containing 3 fuel pins, will be carried out.

2.7 TASK GROUP 1.4 DEVELOPMENT OF ANALYTICAL DESIGN METHODS — ASME CODE CASE SUBMISSION

The data obtained in Task Group 1.3 will be analyzed and expressed in analytical formats suitable for use by designers. Model tests will be carried out as necessary to develop high-temperature design methods. The data and the design methods will be used for preparing a high-temperature ASME Pressure Vessel Code Case for submission.

2.7.1 Objective

The objective of this task is to develop design methods for modified Hastelloy N.

2.7.2 Schedule

The schedule for work in this task group is shown in Table 2.7.2.

2.7.3 Funding

Operating fund requirements for this task group are shown in Table 2.7.3. Capital equipment funds will be required in the amounts of \$50,000 and \$100,000 during FY 1977 and FY 1978 respectively for work related to the development of analytical design methods.

2.7.4 Facilities

It is quite likely that some model testing will be necessary for this task group. Models of complex geometry will be stressed and the deformation compared with that predicted analytically. This will be carried out in the mechanics laboratory in Bldg. 9204-1. The other work will be largely analytical in nature and will make extensive use of the UCC-ND computing facilities.

2.7.5 Task 1.4.1 Data analysis

Large amounts of mechanical property data will be generated in Task Group 1.3. These data will be analyzed in detail and analytical expressions developed for use by designers. Basic data sets and analytical expressions

Table 2.7.2. Schedule for work in Task Group 1.4 — Development of analytical design methods — ASME code case submission

	Fiscal year					
	1975	1976	1977	1978	1979	1980
1.4.1 Data analysis			—	—		
1.4.2 Development of design methods			—	—		
1.4.3 Submission of code case					—	

Table 2.7.3. Operating cost summary for Task Group 1.4 — Development of analytical design methods — ASME code case submission
(costs in 1000 dollars)

	Fiscal year					
	1975	1976	1977	1978	1979	1980
1.4.1 Data analysis			115	200	50	
1.4.2 Development of design methods			100	417	68	
1.4.3 Submission of code case				100	50	
Total operating funds for Task Group 1.4			215	717	168	

will be developed for (1) stress-strain behavior as a function of temperature and strain rate, (2) stress-rupture behavior as a function of temperature, (3) strain-time behavior as a function of temperature and stress level, (4) fatigue response in the form of cycles to failure as a function of strain range at various temperatures, and (5) cumulative damage relationships for adding fatigue and creep damage. The expressions will reflect the data spread due to heat-to-heat variations and experimental uncertainties. Criteria will be developed for discarding erroneous data.

2.7.6 Task 1.4.2 Development of design methods

Design methods will be developed for designing complex systems constructed of modified Hastelloy N. These methods will likely be patterned after the existing high-temperature design code cases for type 304 and 316 stainless steel. The test results from Task 1.3.2 will be used in developing design methods specifically for modified Hastelloy N. Combined analytical and experimental methods will be used to develop design methods for complex stress histories. The initial analytical methods will be those currently being developed for types 304 and 316 stainless steel. Model tests will then be run to confirm that the methods developed for the austenitic stainless steels can be used for Hastelloy N. One such type of loading is multiaxial stresses. Analytical methods exist for predicting creep behavior under multiaxial stresses on the basis of uniaxial test data. Scaled models of actual reactor components will be subjected to multiaxial stresses and the resulting creep behavior measured. Model tests will also be carried out to assist in the development of methods for summing creep and fatigue damage.

The product of this task will be the development of analytical expressions (with appropriate rules for their use) for designing MSBR components.

2.7.7 Task 1.4.3 Submission of code case

After adequate data are obtained and design methods established, a code case will be submitted to the ASME Boiler and Pressure Vessel Committee. This case will officially establish the design rules as being acceptable for use of modified Hastelloy N in nuclear service. A period of 6 months to 1 year will likely be required for approval after the case is submitted. During this time it is quite likely that numerous questions will arise concerning the submitted material. Information will be provided and some further analytical development work may be required.

2.8 TASK GROUP 1.5 LONG-TERM MATERIALS TESTS

Development of MSR's will involve a progression of reactors, each imposing more demanding operation conditions. Task Groups 2.1 through 2.4 are aimed at obtaining materials data that are adequate for design of

the molten-salt test reactor (Section 14); however, additional long term materials data will be required for design of subsequent reactors.

2.8.1 Objective

The objective of this task is to obtain long-term compatibility and mechanical property data on modified Hastelloy N.

2.8.2 Schedule

Work on all tasks in this task group will be carried out continuously during the period FY 1979 through FY 1985.

2.8.3 Funding

Operating fund requirements for this task group are summarized in Table 2.8.3.1, and capital equipment fund requirements are given in Table 2.8.3.2.

2.8.4 Facilities

This task will make use of most of the facilities described in Subsection 2.4.4.

2.8.5 Task 1.5.1 Mechanical property tests

Creep tests of 10,000 hr duration were run in subtask 1.3.2.3. Many of these tests will be continued for times up to 50,000 hrs (~6 yr). Tests of this duration are required to ensure that the material is structurally stable for times within a factor of 5 of the anticipated operating life-time of a reactor. Some of these tests will be run in salt-tellurium environments so that the effects of this environment on the creep behavior can be assessed. It is likely that 16 long-term creep tests will be run in salt and 14 will be run in air.

Some postirradiation creep tests will be continued for times up to 50,000 hr. These tests will define the strain-time behavior of the irradiated modified material at low stresses comparable to those used in reactor design. It is likely that about 12 long-term postirradiation creep tests will be run.

2.8.6 Task 1.5.2 Forced circulation loops

The forced convection loops described in Task 1.3.5 will continue operation for 50,000 hours. Those loops were constructed of two heats of

Total 2.8.3.1. Operating fund requirements for Task Group 1.5 - Long term materials tests
(costs in 1000 dollars)

	Fiscal year								
	1978	1979	1980	1981	1982	1983	1984	1985	1986
1.5.1 Mechanical property tests		650	650	500	500	450	450	300	
1.5.2 Forced circulation loops		150	150	150	150	150	150	100	
1.5.3 In-reactor fueled capsules		200	200	150	150	100	100	100	
Total operating funds for Task Group 1.5		1000	1000	800	800	700	700	500	

Table 2.8.3.2. Capital equipment fund requirements for Task Group 1.5 - Long term materials tests
(costs in 1000 dollars)

	Fiscal year								
	1978	1979	1980	1981	1982	1983	1984	1985	1986
1.5.1 Mechanical property tests		25	25	20	20	15	25	15	
1.5.2 Forced circulation loops		10	10	10	10	10	10	10	
1.5.3 In-reactor fueled capsules		5	25	5	25	5	5	5	
Total capital equipment funds for Task Group 1.5		40	60	35	55	30	40	30	

modified Hastelloy N and two will circulate fuel salt and two will circulate coolant salt. The first 10,000 hours of operation will provide adequate information for design of a molten-salt test reactor (Section 14), but the additional 40,000 hr operation will be very useful for future reactor operation. These four loops will have removable corrosion samples, salt sampling and addition capabilities, and probes for on-line chemical analyses. Continued operation of these loops will provide valuable information on corrosion behavior.

2.8.7 Task 1.5.3 In-reactor fueled capsule tests

At least four fuel pins will be placed in the ORR for long-term operation. These pins will be designed similar to those described in Task 1.3.6. The fuel pins will be fabricated from tubes of the four heats of modified Hastelloy N. Fuel enrichment, irradiation temperature, and irradiation time will be the variables. Operation of one capsule will be terminated each year so that exposure times of 1, 2, 3, and 4 years will result for the capsules. The pins will be examined after irradiation to determine the extent of intergranular cracking, if any. Pieces of the tubes will be deformed after irradiation to determine whether cracks form under these conditions.

2.9 TASK GROUP 1.6 MATERIAL OPTIMIZATION

Although it is expected that the alloy resulting from work in Task Groups 1.1 through 1.5 will be adequate for construction of a molten-salt test reactor (Section 14), a demonstration reactor (Section 15), and commercial power reactors, it is likely that further alloy development will lead to materials which have improved characteristics and may allow a relaxation of design or operating constraints. Attention will also be given to the use of cheaper, more available materials for construction of power reactors.

2.9.1 Objective

The objective of this task is to develop structural materials for the MSBR primary circuit that are superior to the alloy developed in Task Groups 1.1 through 1.5. It is important that these improved materials be pursued for future applications.

2.9.2 Schedule

Work on all tasks in this task group will be carried out continuously during the period of FY 1979 through FY 1985.

2.9.3 Funding

Operating fund requirements for this task group are summarized in Table 2.9.3.1, and capital equipment fund requirements are shown in Table 2.9.3.2.

2.9.4 Facilities

This task will make use of the same facilities as required for Task Group 1.3.

2.9.5 Task 1.6.1 Further Hastelloy N improvement

It is likely that the modified Hastelloy N developed in Task Groups 1.1 through 1.5 will have a maximum service temperature between 1300 and 1400°F. This upper limit is set by the temperature at which the carbide precipitates coarsen and resistance to neutron embrittlement decreases sharply. It would be desirable to develop a material which has a higher temperature limit so that higher temperature transients could be accommodated. Improvement of modified Hastelloy N can likely be effected by additional chemical modifications.

2.9.6 Task 1.6.2 Consideration of other materials

Other potential materials for the MSBR primary circuit offer several advantages over Hastelloy N, but have not been investigated sufficiently to define their limitations. For example, the austenitic stainless steels offer the advantages of lower cost, easier fabricability, and excellent resistance to intergranular cracking by tellurium, but it is not clear what operating conditions (temperature, U^{3+}/U^{4+} ratio) must be maintained in order to obtain an acceptable corrosion rate. Inconel 600 and several similar alloys contain 15 to 20% Cr. The chromium offers improved resistance to embrittlement by tellurium, but will also increase the corrosion rate. The operating conditions will be defined for which the corrosion rate of these materials is acceptable. If the resulting operating conditions warrant further study, additional development work will be done on these materials.

Table 2.9.3.1. Summary of operating fund requirements for Task Group 1.6 - Material optimization (costs in 1000 dollars)

	Fiscal year								
	1978	1979	1980	1981	1982	1983	1984	1985	1986
1.6.1 Further Hastelloy N improvement		250	250	300	300	300	300	300	
1.6.2 Consideration of other materials		50	100	100	140	180	200	220	
Total operating funds for Task Group 1.6		300	350	400	440	480	500	520	

Table 2.9.3.2. Capital equipment fund requirements for Task Group 1.6 - Material optimization (costs in 1000 dollars)

	Fiscal year								
	1978	1979	1980	1981	1982	1983	1984	1985	1986
1.6.1 Further Hastelloy N improvement		25	50	50	50	50	50	50	
1.6.2 Consideration of other materials		10	20	30	30	25	25	25	
Total capital equipment funds for Task Group 1.6		35	70	80	80	75	75	75	

REFERENCES FOR SECTION 2

1. G. M. Adamson, R. S. Crouse, and W. D. Manly, *Interim Report on Corrosion by Alkali-Metal Fluorides: Work to May 1, 1953*, ORNL-2337 (1959).
2. G. M. Adamson, R. S. Crouse, and W. D. Manly, *Interim Report on Corrosion by Zirconium-Base Fluorides*, ORNL-2338 (1961).
3. W. D. Manly et al., "Metallurgical Problems in Molten Fluoride Systems," *Progr. Nucl. Energy Ser. IV* 2: 164 (1960).
4. H. E. McCoy, Jr., "The INOR-8 Story," *ORNL Review* 3: 35 (1969).
5. H. E. McCoy, Jr., and J. R. Weir, Jr., *Materials Development for Molten-Salt Breeder Reactors*, ORNL-TM-1854, pp. 31-33 (1967).
6. H. E. McCoy, Jr., and R. E. Gehlbach, "Influence of Irradiation Temperature on the Creep-Rupture Properties of Hastelloy N," *J. Nucl. Technol.* 11: 45 (1971).
7. R. B. Briggs, *MSR Program Semiann. Progr. Rept. August 31, 1961*, pp. 93-94, ORNL-3215 (1962).
8. J. H. DeVan, MS Thesis University of Tennessee, Knoxville, 1960.
9. H. E. McCoy, Jr., and J. R. Weir, Jr., *Materials Development for Molten Salt Breeder Reactors*, ORNL-TM-1854, pp. 5-14, (1967).
10. P. N. Haubenreich and J. R. Engel, "Experience with the MSRE," *Nucl. Appl. Technol.* 8: 118 (1970).
11. M. W. Rosenthal, P. R. Kasten and R. B. Briggs, "Molten-Salt Reactors - History, Status, and Potential," *Nucl. Appl. Technol.* 8: 107 (1970).
12. R. E. Thoma, *Chemical Aspects of MSRE Operation*, ORNL-4658, p. 53 (December 1971).
13. H. E. McCoy, Jr., *An Evaluation of the Molten-Salt Reactor Experiment Hastelloy N Surveillance Specimens - First Group*, ORNL-TM-1997 (1967).
14. H. E. McCoy, Jr., *An Evaluation of the Molten-Salt Reactor Experiment Hastelloy N Surveillance Specimens - Second Group*, ORNL-TM-2359 (1969).

15. H. E. McCoy, Jr., *An Evaluation of the Molten-Salt Reactor Experiment Hastelloy N Surveillance Specimens - Third Group*, ORNL-TM-2647 (1970).
16. H. E. McCoy, Jr., *An Evaluation of the Molten-Salt Reactor Experiment Hastelloy N Surveillance Specimens - Fourth Group*, ORNL-TM-3063 (1971).
17. H. E. McCoy, Jr., *The MSRE and Its Operation*, report to be published.
18. D. R. Harries, "Neutron Irradiation Embrittlement of Austenitic Stainless Steels and Nickel Base Alloys," *J. Brit. Nucl. Energy Soc.* 5: 74 (1966).
19. G. H. Broomfield, D. R. Harries, and A. C. Roberts, "Neutron Irradiation Effects in Austenitic Stainless Steels and a Nimonic Alloy," *J. Iron Steel Inst. (London)* 203: 502 (1965).
20. N. A. Hughes and J. Caley, "The Effect of Neutron Irradiation at Elevated Temperatures on the Tensile Properties of Some Austenitic Stainless Steels," *J. Nucl. Mater.* 10: 60 (1963).
21. F. C. Robertshaw et al., "Neutron Irradiation Effects in A-286 Hastelloy Y and Rene' 41 Alloys," *ASTM STP 341, American Society for Testing and Materials*, p. 372 (1963).
22. N. E. Hinkle, "Effect of Neutron Bombardment on Stress-Rupture Properties of Some Structural Alloys," *ASTM STP 341, American Society for Testing and Materials*, p. 344 (1963).
23. P. C. L. Pfeil and D. R. Harries, "Effects of Irradiation in Austenitic Steels and Other High-Temperature Alloys," *ASTM STP 380, American Society for Testing and Materials*, p. 202 (1965).
24. W. R. Martin and J. R. Weir, Jr., "The Effect of Irradiation Temperature on the Post-Irradiation Stress-Strain Behavior of Stainless Steel," *ASTM STP 380, American Society for Testing and Materials*, p. 251 (1965).
25. J. T. Venard and J. R. Weir, Jr., "In-Reactor Stress-Rupture Properties of a 20 Cr-25 Ni Columbium-Stabilized Stainless Steel," *ASTM STP 380, American Society for Testing and Materials*, p. 269 (1965).
26. P. C. L. Pfeil, P. J. Barton, and D. R. Arkell, "Effects of Irradiation on the Elevated Temperature Mechanical Properties of Austenitic Steels," *Trans. of American Nucl. Soc.* 8: 120 (1965).

27. P. R. B. Higgins and A. C. Roberts, "Reduction in Ductility of Austenitic Stainless Steel After Irradiation," *Nature* 206: 1249 (1965).
28. W. R. Martin and J. R. Weir, Jr., "Effect of Elevated Temperature Irradiation on the Strength and Ductility of the Nickel-Base Alloy, Hastelloy N," *Nucl. Appl.* 1(2): 160-167 (1965).
29. W. R. Martin and J. R. Weir, Jr., "Postirradiation Creep and Stress Rupture of Hastelloy N," *Nucl. Appl.* 3: 167 (1967).
30. H. E. McCoy, Jr., and J. R. Weir, Jr., "Stress-Rupture Properties of Irradiated and Unirradiated Hastelloy N Tubes," *Nucl. Appl.* 4: 96 (1968).
31. R. E. Thoma, *Chemical Aspects of MSRE Operation*, ORNL-4658 (No. 31), p. 71 (December 1971).
32. *MSR Program Semiann. Progr. Rept. Feb. 29, 1972*, ORNL-4782.
33. *MSR Program Semiann. Progr. Rept. Aug. 31, 1971*, ORNL-4728, p. 145.
34. *MSR Program Semiann. Progr. Rept. Feb. 28, 1971*, ORNL-4676, p. 196.
35. *MSR Program Semiann. Progr. Rept. Aug. 31, 1971*, ORNL-4728, p. 142.
36. E. E. Bloom, "Nucleation and Growth of Voids in Stainless Steel During Fast-Neutron Irradiation," *Radiation-Induced Voids in Metals*, U.S. AEC Office of Information Services, p. 1 (1972).
37. A. A. Bauer and M. Kanglilaski, "Helium Generation in Stainless Steel and Nickel," *J. Nucl. Mater.* 42: 91 (1972).
38. M. W. Rosenthal et al., "Recent Progress in Molten-Salt Reactor Development," *Atomic Energy Rev.* IX: 601 (1971).
39. H. E. McCoy, Jr., and R. E. Gehlbach, "Influence of Zirconium Additions on the Mechanical Properties of a Ni-Mo-Cr Alloy in the Irradiated and Unirradiated Conditions," *J. Nucl. Mater.* 40(2): 151-165 (1971).
40. C. E. Sessions and T. S. Lundy, "Diffusion of Titanium in Modified Hastelloy N," *J. Nucl. Mater.* 31: 316 (1969).
41. E. E. Bloom, *In-Reactor and Postirradiation Creep-Rupture Properties of Type 304 Stainless Steel at 650°C*, ORNL-TM-2130 (1968).

42. E. E. Bloom and J. R. Weir, Jr., "Development of Austenitic Stainless Steels with Improved Resistance to Elevated-Temperature Irradiation Embrittlement," *Irradiation Effects in Structural Alloys for Thermal and Fast Reactors*, American Society for Testing Materials, p. 261 (1969).
43. C. G. Bieber and R. F. Decker, "The Melting of Maleable Nickel and Nickel Alloys," *Trans. AIME* 221: 629 (1961).
44. D. R. Wood and R. M. Cook, "Effects of Trace Contents of Impurity Elements on the Creep-Rupture Properties of Nickel-Base Alloys," *Metallurgia* 109 (1963).
45. J. C. Fisher, *J. Appl. Phys.* 22: 74-77 (1951).

3. FUEL PROCESSING

3.1 INTRODUCTION

3.1.1 Objective

The objective of this activity is the development of technology necessary for the design of a processing system for a 1000-MW(e) MSBR, and for estimating the system performance, reliability, and costs.

3.1.2 Scope

The scope of this activity includes development and analysis of processing plant flowsheets; study of the chemistry on which process operations are based; and design and operation of engineering experiments and facilities required for developing the necessary fuel processing technology.

3.1.2.1 Task Group 2.1 Flowsheet analysis

As promising flowsheets are developed, existing computer codes will be used and new codes will be developed, when necessary, to determine the feasibility of the flowsheets and to identify proper operating conditions. This task group covers heat and mass balance calculations, parametric and optimization studies, waste characterization, processing plant cost estimates, processing plant control studies, and identification of alternate processes.

3.1.2.2 Task Group 2.2 Continuous fluorinator development

This task group is directed to the development of technology required for the removal of uranium from fuel salt by fluorination. The work includes development of heat sources for nonradioactive tests, fluorination chemistry, frozen wall corrosion protection studies, hydrodynamic and mass transfer studies, and the design and operation of experimental facilities for engineering studies of fluorination. This task group interfaces with Task Group 2.3 in the Fluorination-Reconstitution Engineering Facility.

3.1.2.3 Task Group 2.3 Fuel reconstitution

This task group is directed to the development of technology required for recombination of uranium removed in the fluorination step with the processed fuel salt before its return to the reactor; this is accomplished by absorbing the UF_6 into salt containing UF_4 to produce soluble UF_5 , and subsequently reducing the UF_5 to UF_4 with hydrogen. This task group covers investigations of the chemistry of the reconstitution process, engineering studies for process development, and the design and operation of a combined fluorination-reconstitution facility. This task group interfaces with Task Group 2.2 in the Fluorination-Reconstitution Engineering Facility.

3.1.2.4 Task Group 2.4 Protactinium removal

Protactinium-233 must be isolated and allowed to decay to ^{233}U outside the reactor in order to avoid an undesirable decrease in breeding performance. The present flowsheet calls for extracting ^{233}Pa from the fuel salt into molten bismuth containing dissolved reductant. This task group includes development of salt-metal contactors for performing the extraction, development of continuous hydrofluorinators and hydrochlorinators for salt-bismuth systems, operation of a continuous Reductive Extraction Process Facility for carrying out engineering studies of the process, and the design, construction, and operation of an experiment to demonstrate isolation of protactinium using ^{231}Pa . This task group interfaces with Task Group 2.5 in the development of salt-bismuth contactors.

3.1.2.5 Task Group 2.5 Rare-earth removal

The present flowsheet calls for removal of rare earths from the fuel salt using the metal transfer process. This task group covers the development of salt-bismuth contactors, operation of Metal Transfer Experiment MTE-3B, and design, construction, and operation of a facility for engineering studies of the metal transfer process using flow rates which are about 10% of those required in a 1000-MW(e) MSBR.

3.1.2.6 Task Group 2.6 Fuel salt purification

Before fuel salt is returned to the reactor from the processing plant the oxidation potential of the fuel salt must be adjusted to a proper level and traces of bismuth and corrosion products must be removed. This task group covers development of processes for continuously adjusting the oxidation potential by means of measuring and controlling the $[\text{U}^{+4}]/[\text{U}^{+3}]$ ratio in the fuel salt, and the development of processes for removing entrained and dissolved bismuth from the fuel salt.

3.1.2.7 Task Group 2.7 Actinide-fission product separation and actinide recycle

The actinides constitute a long-term waste hazard and it is desirable to develop means for recycling them for transmutation to less undesirable isotopes in the reactor. This task group covers the studies of the necessary chemistry for separating actinides from fission products to allow actinide recycle, the development and analysis of flowsheets for implementing these types of processes, and the identification of the required engineering development activities. This task group interfaces with Task Group 2.1 in the development and analysis of flowsheets.

3.1.2.8 Task Group 2.8 MSBR Processing Engineering Laboratory

This task group covers the design (conceptual, Title I, and Title II), construction, and acceptance testing for a general laboratory facility in which large engineering development work can be carried out. The facility will be used for a number of engineering studies related to processing MSBR fuel.

3.1.2.9 Task Group 2.9 Integrated Process Test Facility

The several process steps must be combined in an integrated pilot plant which would demonstrate the operability of a fuel processing system using flow rates that are 50 to 75% of those required for a 1000-MW(e) MSBR in a nonradioactive system. This task group covers the preliminary design, the development work required for final design, the design (conceptual, Title I and Title II), equipment construction and installation, the initial testing and operator training, and the operation of the Integrated Process Test Facility.

3.1.2.10 Other activities

Other activities which will be carried out on the development of fuel processing technology include the design, construction, and operation of a processing system in the Molten-Salt Test Reactor Mock-up (Section 13), the design, construction, and operation of a processing plant to be operated in conjunction with the Molten-Salt Test Reactor (Section 14), and the design, construction, and operation of a processing plant for in-line processing of a Molten-Salt Demonstration Reactor (Section 15).

3.2 PROGRAM BUDGET AND SCHEDULE

3.2.1 Schedule and key program milestones

A summary schedule for the area of fuel processing is shown in Table 3.2.1.1. The key program milestones for this activity are listed in Table 3.2.1.2 and occur at the times shown in Table 3.2.1.1.

3.2.2 Budget

A summary of the operating budget for this activity is shown in Table 3.2.2.1. Table 3.2.2.2 shows requirements for capital equipment funds. GPP funds in the amount of \$355,000 will be required during FY 1976 for modification of Cell 2, Bldg 3019, for the Protactinium Isolation Demonstration Experiment.

Table 3.2.1.1. Schedule for MSBR fuel processing showing key milestones

Task Group	Fiscal year												
	1975	1976	1977	1978	1979	1980	1981	1982	1983	1984	1985	1986	
2.1 Flowsheet analysis and development													
2.2 Continuous fluorinator development	∇ ^a		∇ ^b	∇ ^c									
2.3 Fuel Reconstitution		∇ ^d		∇ ^c									
2.4 Protactinium removal	∇ ^e			∇ ^f ∇ ^g									
2.5 Rare-earth removal		∇ ^h		∇ ⁱ									
2.6 Fuel salt purification				∇ ^{j,k}									
2.7 Actinide-fission product separation and actinide recycle		∇ ^l											
2.8 MSBR Processing Engineering Laboratory design and construction							∇ ^m						
2.9 Integrated Process Test Facility								∇ ⁿ				∇ ^o	

Table 3.2.1.2. Key milestones for MSBR fuel processing

Milestone	Description
a	Demonstrate autoresistance heating for use in a frozen wall fluorinator
b	Complete studies of continuous fluorination in engineering facility
c	Complete studies of combined fluorination-recombination in engineering system on 25 to 50% MSBR scale
d	Complete engineering studies of fuel reconstitution necessary for design of Fluorination-Reconstitution Engineering Experiment
e	Complete engineering studies of reductive extraction in a mild steel flow-through system
f	Complete engineering studies of reductive extraction in Reductive Extraction Process Facility
g	Demonstrate isolation of Pa by reductive extraction using gram-quantities of ^{231}Pa
h	Complete experiment MTE-3B on 1% MSBR scale
i	Complete engineering experiment MTE-4 on 5-10% MSBR scale
j	Demonstrate continuous adjustment of uranium valence
k	Demonstrate removal of trace quantities of bismuth
l	Issue report which describes development activities necessary for the actinide recycle flowsheet
m	Complete construction of MSBR Processing Engineering Laboratory
n	Complete installation of Integrated Process Test Facility
o	Complete operations and tests with Integrated Process Test Facility

Table 3.2.2.1. Summary of operating budget for MSBR fuel processing
(costs in 1000 dollars)

	Fiscal year											
	1975	1976	1977	1978	1979	1980	1981	1982	1983	1984	1985	1986
2.1 Flowsheet analysis and development		105	180	200	70							
2.2 Continuous fluorinator development	222	455	375	240								
2.3 Fuel reconstitution	152	259	170	235								
2.4 Protactinium removal	219	366	405	360	25							
2.5 Rare-earth removal	208	155	180	150								
2.6 Fuel salt purification		45	75	75								
2.7 Actinide-fission product separation and actinide recycle	50											
2.8 MSBR Processing Engineering Laboratory design and construction	80	50	250	295	150	190						
2.9 Integrated Process Test Facility		165	190	240	350	275	591	2458	2824	2824	2700	
Total fuel processing operating funds	931	1600	1825	1795	595*	465*	591*	2458	2824	2824	2700	

*Additional funds related to fuel processing will be required during these years to support conceptual design of processing systems for a molten-salt test reactor and test reactor mockup, hence the variation in overall support level will be much less abrupt.

Table 3.2.2.2. Summary of capital equipment and capital project funds required for MSBR fuel processing
(costs in 1000 dollars)

	Fiscal year											
	1975	1976	1977	1978	1979	1980	1981	1982	1983	1984	1985	1986
<u>Capital Equipment and Facilities</u>												
2.2 Continuous fluorinator development	50	200										
2.3 Fuel reconstitution	5	125										
2.4 Protactinium removal		190	400									
2.5 Rare-earth removal		200										
2.6 Fuel salt purification			25									
2.9 Integrated Process Test Facility: data processing computer						400		200	300	400	300	
Total capital equipment funds	55	715	425			400		200	300	400	300	
<u>Capital Projects</u>												
2.8 MSBR Processing Engineering Laboratory			12,000									
2.9 Integrated Process Test Facility					7000							

3.3 REQUIREMENTS, BACKGROUND, AND STATUS OF DEVELOPMENT

3.3.1 Processing requirements

Operation of a molten-salt reactor as a high-performance breeder is made possible by the continuous processing of the fuel salt in a facility that is located at the reactor site. The most important operations consist in removing fission products (principally the rare earths) and isolating ^{233}Pa from the region of high neutron flux during its decay to ^{233}U in order to hold neutron absorption in these materials to an acceptably low level. It is also necessary that excess uranium produced in the system be removed for sale, that the fuel salt be maintained at the proper redox potential, and that the oxide and corrosion product concentrations in the salt be maintained at tolerable levels.

The rates at which the fuel salt must be processed for ^{233}Pa removal and rare-earth removal are mutually dependent. It will be convenient to define the term "processing cycle time" as the time required for processing a volume of fuel salt equal to that contained in the reactor system. The "removal time" for a given material is then an effective cycle time that is equal to the processing cycle time divided by the fraction of the material that is removed in a pass through the processing system. For a particular single-fluid MSBR having a breeding ratio of 1.07, the required rare-earth removal time can range from 50 days for a protactinium removal time of 3 days to about 11 days for a protactinium removal time of 20 days. The optimum choice of protactinium and rare-earth removal times is largely dependent on the characteristics of the processes employed. For example, the present rare-earth removal process requires that protactinium be removed from the salt prior to the removal of rare earths. Hence, with this process, the rare-earth removal time will always be as long as or longer than the protactinium removal time. A protactinium removal time of 10 days and a rare-earth removal time of about 27 days are used with the reference processing system.

3.3.2 Background

Processing of MSBR fuel salt is based principally on three types of operations: removal of uranium from the salt by fluorination; the selective removal of protactinium, rare earths, and other fission products from the salt by extraction into molten bismuth; and the recombination of uranium with the processed salt by the hydrogen reduction of UF_6 to UF_4 in the presence of the processed fuel carrier salt. In addition to these principal operations there is the necessity for auxiliary support systems and operations required for close-coupled fuel processing.

The chemical basis on which the processing system is founded is well understood; however, only small engineering experiments have been carried out to date and a considerable engineering development effort remains.

3.3.2.1 Removal of uranium from molten salts by fluorination

There is a considerable background and operating experience related to the removal of uranium from molten fluoride mixtures by contact with elemental fluorine. Initial work in this area was related to the recovery of uranium from the irradiated fuel salt of the Aircraft Reactor Experiment. The success of the development work led to formation of the Fused Salt Fluoride Volatility Program at ORNL and operation of a pilot plant for batch fluorination of the irradiated ARE fuel salt.²² Operation of the pilot plant was highly successful, and upon completion of ARE fuel processing, laboratory work was initiated for the development of a fuel element dissolution operation based on contact of fuel elements with hydrogen fluoride in the presence of fused fluoride mixtures in order to extend the Volatility Process to other reactor fuels. This work culminated in the highly successful recovery of uranium from various irradiated zirconium-, aluminum-, and stainless steel-based fuels,²³ which in some cases were processed as early as 30 days after fuel discharge.²⁴ Uranium recoveries greater than 99% and uranium decontamination factors in excess of 10^9 were consistently demonstrated.

More recently the Fused Salt Fluoride Volatility Process was used for removal of the ^{235}U - ^{238}U mixture from the MSRE fuel salt at the MSRE site after the reactor had operated for about 1.5 years.²⁵ This operation was also highly successful, and the fuel carrier salt was subsequently combined with ^{233}U and returned to the MSRE for an additional year of operation.

While there are a number of differences between the experience gained with the Fluoride Volatility Process and information required for continuous removal of uranium from MSBR fuel salt, the Volatility Process experience indicates conclusively that uranium can be removed from a variety of fused fluoride mixtures in essentially a quantitative manner, and the broad experience on fission product behavior, materials of construction, and remote operation is directly applicable in many important cases.

3.3.2.2 Recombination of UF_6 with processed fuel carrier salt

There is a vast experience in the high-temperature gas phase reduction of UF_6 to UF_4 by contact with hydrogen, and this operation has been successfully carried out in a number of uranium processing facilities. Initially, attention was given to use of a scaled-down reduction reactor of this type for recombining UF_6 with processed MSBR fuel carrier salt. However, consideration of the difficulties associated with equipment scale-down, UF_4 product collection and holdup, and remote operation prompted a search for a more direct means for recombining UF_6 with molten fluoride mixtures. The known interactions between UF_6 and UF_4 in the absence of molten salt leading to the formation of slightly volatile fluorides such as UF_5 , and the observation that UF_5 is formed during fluorination of molten fluorides containing UF_4 , suggested that

UF₆ could be absorbed directly into molten salt that contained UF₄. Subsequent experiments verified that the absorption reaction is rapid and that UF₆ can be combined quantitatively with molten fluorides containing UF₄ with the simultaneous formation of intermediate fluorides having a low volatility.¹

In the fuel reconstitution step, a gas stream containing UF₆ and F₂ will be reacted with a recirculating salt stream containing dissolved UF₄ according to the reactions



and



The dissolved UF₅ will be reduced in a separate chamber according to the reaction

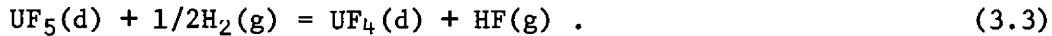

Preliminary results¹ indicate that reaction (3.3) occurs more slowly than reaction (3.2); however, the full significance of this in the fuel reconstitution step is not known.

3.3.2.3 Distribution of metals between molten salts and bismuth

Bismuth is a low-melting (271°C) metal that is essentially immiscible with molten halide mixtures consisting of fluorides, chlorides, and bromides. The vapor pressure of bismuth in the temperature range of interest (500 to 700°C) is negligible, and the solubilities of lithium, thorium, uranium, protactinium, and most of the fission products are adequate for processing applications.

Under the conditions of interest, reductive extraction reactions between materials in salt and metal phases can be represented by the following reaction:

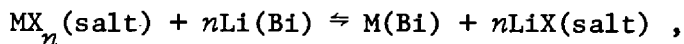

in which the metal halide MX_n in the salt reacts with lithium from the bismuth phase to produce M in the bismuth phase and the respective lithium halide in the salt phase. The valence of M in the salt is +n, and X represents fluorine, chlorine, and bromine. It has been found² that the distribution coefficient *D* for metal M depends on the lithium concentration in the metal phase (mole fraction, X_{Li}) as follows:

$$\log D = n \log X_{\text{Li}} + \log K_m^* \quad .$$

The quantity K^* is dependent only on temperature, and the distribution coefficient is defined by the relation:

$$D = \frac{\text{mole fraction of M in metal phase}}{\text{mole fraction of } MX_n \text{ in salt phase}}$$

The ease with which one component can be separated from another is indicated by the ratio of the respective distribution coefficients, that is, the separation factor. As the separation factor approaches unity, separation of the components becomes increasingly difficult. On the other hand, the greater the deviation from unity, the easier the separation.

Distribution data have been obtained² for a large number of elements, including all of those of importance, between fuel salt (72-16-12 mole % LiF-BeF₂-ThF₄) and bismuth. Under the expected process conditions, the Pa-Th separation factor is about 1200, which indicates that protactinium as well as uranium and zirconium can be easily extracted from a salt stream containing ThF₄. However, the rare-earth--thorium separation factors are close to unity (1.2 to 3.5), indicating that direct selective extraction of the rare earths from a salt containing thorium fluoride would be difficult. A previous rare-earth removal method was based on these low separation factors and required a large number of stages, a high metal-to-salt flow ratio, and a large electrolytic cell for providing thorium and rare-earth reflux at the ends of the extraction cascade (ref. 3, pp. 170-78; ref. 4, pp. 52-77).

It was found subsequently that with LiCl or LiBr, much more favorable thorium--rare-earth separation factors are obtained (ref. 21, p. 285). Distribution data for LiCl (ref. 5, p. 171;7) falls roughly into three groups. The divalent rare-earth and alkaline-earth elements distribute most readily to the LiCl, with thorium--rare-earth separation factors of about 10⁸. The trivalent rare earths have thorium--rare-earth separation factors of about 10⁴. Tetravalent materials, such as thorium and protactinium, distribute only slightly to LiCl. Studies on the temperature dependence of the distribution data show essentially no effect for the divalent elements, a minor effect for the trivalent elements, and a somewhat greater effect for the tetravalent elements. The distribution coefficient for thorium is decreased sharply by the addition of fluoride to the LiCl, although the distribution coefficients for the rare earths are affected by only a minor amount. Thus, contamination of the LiCl with several mole percent fluoride will not affect the removal of the rare earths but will cause a sharp increase in the thorium removal rate. Data with LiBr⁶ are similar to those with LiCl, and the distribution behavior with LiCl-LiBr mixtures would likely not differ appreciably from the data with the pure materials.

3.3.2.4 Protactinium removal system

The reference protactinium removal system (ref. 7, pp. 3-21) is based on fluorination for uranium removal and reductive extraction for protactinium isolation. Fuel salt containing 0.33 mole % UF_4 and approximately 0.0035 mole % PaF_4 is withdrawn from the reactor. About 99% of the uranium is removed from the salt by fluorination in order to avoid the use of large quantities of reductant in the subsequent protactinium removal step. The salt stream is fed countercurrent to a bismuth stream containing lithium and thorium, where the remaining uranium and the protactinium transfer to the metal stream. These materials are transferred from the bismuth to a captive secondary salt by hydrofluorinating the bismuth stream leaving the extraction column in the presence of the secondary salt. The secondary salt which flows through the hydrofluorinator also circulates through a fluorinator, where about 90% of the uranium is removed, and through a tank that contains most of the protactinium. Lithium is added to the bismuth leaving the hydrofluorinator, and the resulting stream is returned to the top of the extraction column. The salt leaving the extraction column is essentially free of uranium and protactinium but contains the rare earths at essentially the reactor concentration. This stream is fed to the rare-earth removal system.

3.3.2.5 Rare-earth removal process

In the reference rare-earth removal system (ref. 8, pp. 1-15) fuel salt, which is free of uranium and protactinium but contains the rare earths, is countercurrently contacted with bismuth containing reductant in order to extract a significant fraction of the rare earths into the bismuth. The bismuth stream, which contains the rare earths and thorium, is then countercurrently contacted with lithium chloride. Because of highly favorable distribution coefficients, significant fractions of the rare earths transfer to the $LiCl$ along with a negligible amount of thorium. The final steps of the process consist in extracting the rare earths from the $LiCl$ by contact with bismuth having lithium concentrations of 5 and 50 at. %.

This process has a number of very desirable characteristics. Of primary importance is the fact that there is no net consumption of reductant in the two upper contactors. The process is not sensitive to minor variations in operating conditions. Essentially no materials other than the rare-earth and alkaline-earth elements are removed from or added to the fuel salt; the major change consists in replacing the extracted rare earths with an equivalent amount of lithium as LiF . The amount of LiF added to the fuel salt in this manner during 30 years of operation would be less than 10% of the LiF inventory in the reactor.

3.3.2.6 Conceptual processing plant flowsheet

The reference processing flowsheet (ref. 7, pp. 3-21) is shown in Fig. 3.1. Fuel salt is withdrawn from the reactor on a 10-day cycle; for a 1000-MW(e) reactor, this represents a flow rate of 0.88 gpm. The fluorinator removes 99% of the uranium. The protactinium extraction contactor is equivalent to five equilibrium stages. The bismuth flow rate through the contactor is 0.13 gpm, and the inlet thorium concentration in the stream is 90% of the thorium solubility at the operating temperature of 640°C. The protactinium decay tank has a volume of 160 ft³. The uranium inventory in the tank is less than 0.2% of that in the reactor. Fluorides of lithium, thorium, zirconium, and nickel accumulate in the tank at a total rate of about 0.1 ft³/day. These materials are removed by periodic withdrawal of salt to a final protactinium decay and fluorination operation.

The bismuth flow rate through the two upper contactors in the rare-earth removal system is 12.5 gpm, and the LiCl flow rate is 33 gpm. Each contactor is equivalent to three equilibrium stages.

The trivalent and divalent rare earths are removed in separate contactors in order to minimize the amount of lithium required. Only 2% of the LiCl, or 0.66 gpm, is fed to the two-stage divalent rare-earth removal contactor, where it is contacted with a 0.58-gal/day bismuth stream containing 50 at. % lithium. The trivalent stripper, where the LiCl is contacted with bismuth containing 5 at. % lithium, is equivalent to one equilibrium stage.

The bismuth stream containing the reductant necessary for the isolation of protactinium is actually fed to the recirculating bismuth stream in the rare-earth removal system. An equivalent amount of bismuth is withdrawn from the stream and is fed to the protactinium isolation column. This allows for more nearly complete extraction of the protactinium and provides a means for removing materials which might otherwise accumulate in the recirculating stream.

The remaining steps in the flowsheet consist in combining the processed salt with uranium and purifying the resulting fuel salt. The uranium addition is accomplished by absorbing the UF₆-F₂ stream from the fluorinators into fuel salt containing UF₄, which results in the formation of soluble UF₅. The UF₅ is then reduced to UF₄ by contact with hydrogen. The HF resulting from reduction of UF₅ is electrolyzed in order to recycle the contained fluorine and hydrogen. These materials are recycled in order to avoid waste disposal charges on the material that would be produced if the HF were absorbed in an aqueous solution of KOH.⁹ The salt will be contacted with nickel wool in the purification step in order to ensure that the final bismuth concentration is acceptably low.

The protactinium removal time obtained with the flowsheet is 10 days, and the rare-earth removal times range from 17 to 51 days, with the rare earths of most importance being removed on 27- to 30-day cycles. Calculations (ref. 7, pp. 3-21; ref. 8, pp. 1-15) indicate that the flowsheet is relatively insensitive to minor variations in operating conditions, such as

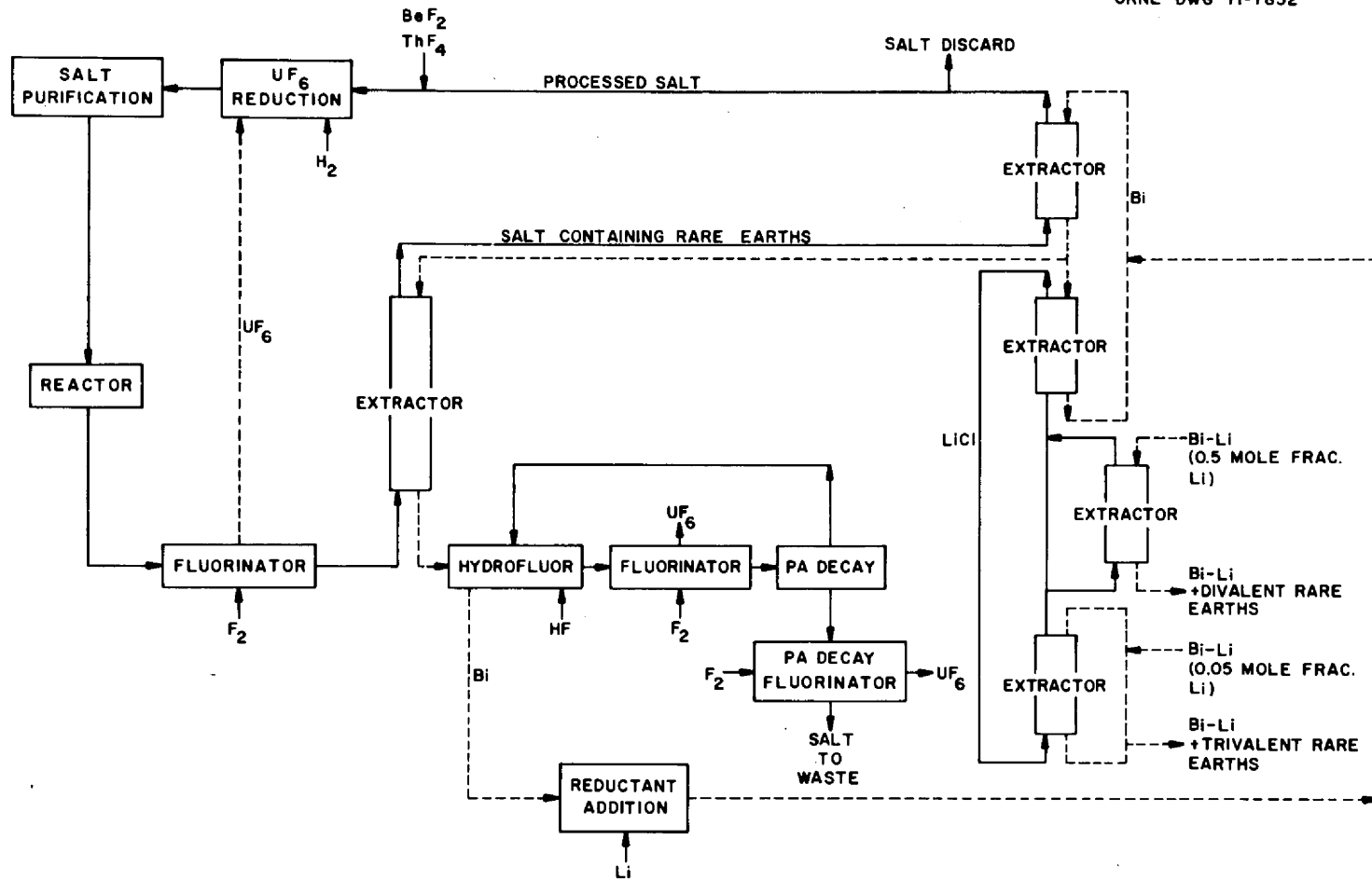

Fig. 3.1. Conceptual flowsheet for processing a single-fluid MSBR by fluorination-reductive extraction and the metal transfer process.

changes in temperature, flow rates, reductant concentrations, etc. It was noted earlier, however, that the thorium--rare-earth separation factor decreases sharply as the concentration of fluoride in the LiCl is increased; contamination of the LiCl would result from entrainment of fuel salt by the bismuth stream leaving the upper contactor. The effect is largely an increase in the rate at which thorium is removed with the rare earths. The thorium removal rate increases from about 0.4 mole/day with no fluoride in the LiCl to about 280 moles/day when the LiCl contains the equivalent of 5 mole % LiF. It appears that the fluoride concentration in the LiCl could economically be as high as 2 mole %, which corresponds to a thorium discard rate of 7.7 moles/day. Discard of thorium at this rate would add only about 0.0013 mill/kWhr to the power cost; however, the presence of thorium in the resultant waste complicates waste disposal considerations. The effect of fluoride in the LiCl on the removal of rare earths is negligible. In fact, the rare-earth removal efficiency increases slightly as the fluoride concentration in the LiCl increases. In addition, contact of LiCl containing fluoride with volatile BiCl_3 results in formation of volatile BF_3 (ref. 10, p. 106), and thus fluoride can be removed from LiCl easily by this means.

The reliable removal of decay heat from the processing plant is an important consideration because of the relatively short decay time before the salt enters the processing plant. A total of about 6 MW of heat would be produced in the processing plant for a 1000-MW(e) MSBR. Since molten bismuth, fuel salt, and LiCl are not subject to radiolytic degradation, there is not the usual concern encountered with processing of short-decayed fuel.

3.3.3 Status of development

3.3.3.1 Continuous fluorinator development

Studies have been carried out previously¹¹ on fluorination of molten salt in a 1-in.-diam, 72-in.-long nickel fluorinator that allowed countercurrent contact of molten salt with fluorine. In these tests, molten salt (41-24-35 mole % NaF-LiF-ZrF₄) containing UF₄ was countercurrently contacted with a quantity of fluorine in excess of that required for the conversion of UF₄ to UF₆. Experiments were carried out with temperatures ranging from 525 to 600°C, UF₄ concentrations in the feed salt ranging from 0.12 to 0.35 mole %, and a range of salt and fluorine feed rates. The fraction of the uranium removed from the salt ranged from 97.5% to 99.9%.

Axial dispersion in the salt phase will be important in the design of continuous fluorinators, and gas holdup and axial dispersion have been measured in columns having diameters ranging from 1 to 6 in. using air and aqueous solutions. Data were obtained for wide ranges of viscosity, surface tension, and superficial gas velocity. Correlations for gas holdup and axial dispersion were developed¹² which are believed to be applicable to countercurrent contact of molten salt and fluorine in a continuous fluorinator. These correlations and the data on uranium

removal in the 1-in.-diam continuous fluorinator were used for estimating the performance of larger diameter continuous fluorinators (ref. 12, p. 41).

The combination of molten salt and fluorine results in a highly corrosive environment, and it will be necessary to protect a continuous fluorinator from corrosion by maintaining a layer of frozen salt on surfaces that would otherwise contact both molten salt and fluorine. Use of a frozen salt layer for preventing the dissolution of nickel fluoride from a nickel surface will allow passivation of the nickel to occur.

The feasibility of maintaining frozen salt layers in gas-salt contactors was demonstrated previously⁸ in tests in a 5-in.-diam, 8-ft-high simulated fluorinator in which molten salt (66-34 mole % LiF-ZrF₄) and argon were countercurrently contacted. An internal heat source in the molten region was provided by Calrod heaters contained in a 3/4-in.-diam pipe along the center line of the vessel. A frozen salt layer was maintained in the system with equivalent volumetric heat generation rates of 10 to 55 Kw/ft³. For comparison, the heat generation rates in fuel salt immediately after removal from the reactor and after passing through vessels having holdup times of 5 and 30 min are 57, 27, and 12 kW/ft³, respectively.

Operation of a continuous fluorinator with nonradioactive salt requires a means for generating heat in the molten salt that is not subject to corrosion. Radio-frequency induction heating was studied in fluorinator simulations using nitric acid¹³ and auto-resistance heating using 60-Hz power with molten salt (65-35 mole % LiF-BeF₂) was studied in a 6-in.-diam fluorinator simulator.¹⁴ Autoresistance heating is the preferred method, since it can be used over a wider range of operating conditions and since the electrical power supply is much simpler than that required for induction heating.

3.3.3.2 Fuel reconstitution

Studies of the absorption of UF₆ by MSBR fuel carrier salt containing UF₄ have been carried out.¹⁴ Absorption of UF₆ in fuel carrier salt containing UF₄ has been shown to result in the formation of soluble nonvolatile UF₅ according to the following reaction:

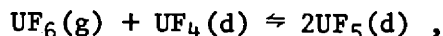

in which (g) denotes gas and (d) denotes species dissolved in the salt. The recent studies have also shown that gaseous hydrogen reacts with dissolved UF₅ according to the reactions:

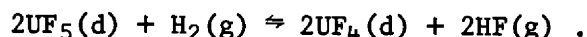

Since both UF₆ and UF₅ are strong oxidants, the initial experiments were conducted primarily to find a material that was inert to these species.

It was found that at 600°C, nickel, copper, and graphite are not sufficiently inert but that gold is stable both to gaseous UF_6 and to salt containing up to 6 wt % UF_5 . Consequently, current studies are being conducted in gold apparatus. Future experiments will be carried out with UF_6 - F_2 mixtures in order to determine the effect of the presence of fluorine in the gas stream. The behavior of the fluorides of iodine and neptunium in this step will also be determined.

Results from several experiments show that UF_5 undergoes gas phase disproportionation to UF_6 and UF_4 . The studies also indicate that the solubility of UF_6 in the salt is low. Engineering experiments are being designed for further study of the absorption of UF_6 - F_2 mixtures in molten salt containing UF_4 and the subsequent reduction of UF_5 by contact of the salt with hydrogen.

3.3.3.3 Protactinium removal

A salt-bismuth reductive extraction facility has been operated successfully in which uranium and zirconium were extracted from salt by counter-current contact with bismuth containing reductant (ref. 7, pp. 64-89; ref. 14). More than 95% of the uranium was extracted from the salt by a 0.82-in.-diam, 24-in.-long packed column. The inlet uranium concentration in the salt was about 25% of the uranium concentration in the reference MSBR. These experiments represent the first demonstration of reductive extraction of uranium in a flowing system. Information on the rate of mass transfer of uranium and zirconium has also been obtained in the system using an isotopic dilution method, and HTU values of about 4.5 ft were obtained.

Correlations have been developed (ref. 15, pp. 102-17; ref. 12) for flooding and dispersed-phase holdup in packed columns during countercurrent flow of liquids having high densities and a large difference in density, such as salt and bismuth. These correlations, which have been verified by studies with molten salt and bismuth (ref. 7, pp. 64-89), were developed by study of countercurrent flow of mercury and water or high-density organics and water in 1- and 2-in.-diam columns packed with solid cylinders and Raschig rings varying in size from 1/8 to 1/2 in. Data on axial dispersion in the continuous phase during the countercurrent flow of high-density liquids in packed columns has also been obtained (ref. 16, pp. 58-89; ref. 17), and a simple relation for predicting the effects of axial dispersion on column performance¹⁸ has been developed.

The successful operation of salt-metal extraction columns is dependent upon the availability of a bismuth-salt interface detector. The successful operation of an eddy-current-type interface detector that consists of a ceramic form on which bifilar primary and secondary coils were wound was demonstrated recently.¹⁴ Contact of the coils with molten salt or bismuth is prevented by enclosing the element in a molybdenum tube. Passage of a high-frequency alternating current through the primary coil induces a current in the secondary coil whose magnitude is dependent on the conductivities of the adjacent materials; since the conductivities of bismuth and salt are quite different, the induced current

reflects the presence or absence of bismuth. The detector appears to be a practical and sensitive indicator of either salt-bismuth interface location or bismuth level.

Because column-type contactors will be expensive to build and because of the likelihood of entraining bismuth into the fuel salt and introducing it into the reactor, a mechanically agitated contactor in which the phases are relatively mildly agitated and are not dispersed is being considered. Most of the experimental work reported in the literature for this type contactor has been done with partially miscible solvent-water systems that produce Reynolds numbers almost an order of magnitude lower than those expected in salt-bismuth systems. The variables of greatest significance in correlating mass transfer rates in this type contactor are believed to be the surface tension and the kinematic viscosity (μ/ρ). These properties of the mercury-water system are close to the same properties of molten salt-bismuth systems, and experiments were carried out for determining mass transfer coefficients with the mercury-water system in order to verify the applicability of reported mass transfer correlations to salt-bismuth systems. The mass transfer performance of this type of contactor is strongly dependent on cell geometry, and tests were carried out using rectangular contactors having cross sectional areas as large as 1 ft². Agitators having a range of diameters and paddle characteristics were used. In the tests, the rate of transfer of lead from dilute Pb(NO₃)₂ solutions into a zinc-mercury amalgam was measured and the mass transfer rates were compared with literature correlations. Although all literature correlations reproduced the aqueous-organic data fairly well, they did not correlate the mass transfer data from the water-mercury system. A correlation was developed which correlates the aqueous-organic data of others as well as the water-mercury data. A 6-in.-diam contactor was installed in the flow-through reductive extraction facility in place of the packed column contactor previously used in order to obtain additional mass transfer coefficient data. The mass transfer rates observed in the salt-bismuth system are higher than those predicted by the recently developed correlation.

Design and development work has been initiated on a Reductive Extraction Process Facility¹⁴ that will allow operation of the important steps for the reductive extraction process for protactinium isolation. The facility will allow countercurrent contact of salt and bismuth streams in various types of contactors at flow rates as high as about 25% of those required for processing a 1000-MW(e) MSBR. The facility will operate continuously and will allow measurement of mass transfer and hydrodynamic data under steady-state conditions.

3.3.3.4 Rare-earth removal

An engineering experiment was carried out which demonstrated all aspects of the metal transfer process¹² for the removal of rare earths. The equipment consisted of a 6-in.-diam compartmented vessel in which were present about 1 liter each of MSBR fuel carrier salt, bismuth saturated

with thorium, and LiCl. The fluoride salt initially contained $^{147}\text{NdF}_3$ at the tracer level and LaF_3 at a concentration of 0.04 mole fraction. During the experiment, the rare earths were selectively extracted into the LiCl along with a negligible amount of thorium. Provision was made for circulating the LiCl through a chamber containing bismuth having a lithium concentration of 38 at. %, where the rare earths and thorium were removed. The distribution ratios for the rare earths remained constant during the experiment at about the expected values. About 50% of the neodymium and about 70% of the lanthanum were collected in the Li-Bi solution. The final thorium concentration in the Li-Bi solution was below 5 ppm, making the ratio of rare earths to thorium in the Li-Bi greater than 10^5 times the initial concentration ratio in the fuel salt and thus demonstrating the selective removal of rare earths from a fluoride salt containing thorium.

A larger metal transfer experiment (ref. 19, pp. 254-55; ref. 20, pp. 209-12; ref. 14) has been operated that used salt and bismuth flow rates that were about 1% of the values required for processing a 1000-MW(e) MSBR, and the preliminary design has been carried out for an experiment that will use a three-stage salt-metal contactor and flow rates that are 5 to 10% of those required for a 1000-MW(e) MSBR.¹⁴

3.3.3.5 Bismuth removal and uranium valence adjustment

In a processing plant, the fuel salt will be contacted with bismuth containing reductant in order to remove protactinium and the rare earths. It will be necessary that entrained or dissolved bismuth be removed from the salt before it is returned to the reactor, since nickel is quite soluble in bismuth (about 10 wt %) at the reactor operating temperature. Efforts to measure the solubility of bismuth in salt have indicated that the solubility is lower than about 1 ppm, and the expected solubility of bismuth in the salt is very low under the highly reducing conditions that will be used. For these reasons, it is believed that bismuth can only be present at significant concentrations in the salt as entrained metallic bismuth.

In order to characterize the bismuth concentration likely to be present in the salt after it is contacted with bismuth, we have done periodic sampling of salt in engineering experiments involving contact of salt and bismuth. The results indicated that the bismuth concentration in the salt in most cases ranges from 10 to 100 ppm after countercurrent contact of the salt and bismuth in a packed-column contactor; however, concentrations below 1 ppm are observed in salt leaving a stirred-interface salt-metal contactor in which the salt and metal phases are not dispersed. One of the present difficulties is preventing contamination of the samples with small quantities of bismuth during cleaning of the samples and the ensuing chemical analyses.

A natural circulation loop constructed of Hastelloy N and filled with fuel salt has been operated for about two years; a molybdenum cup containing bismuth was placed near the bottom of the loop. To date, the

reported concentrations of bismuth in salt from the loop (<5 ppm) are essentially the same as those reported for salt from a loop containing no bismuth. No degradation of metallurgical properties for corrosion specimens removed from the loop containing bismuth has been noted.

Operation of a molten-salt reactor with a small fraction (less than 1%) of the uranium present as UF_3 is advantageous in order to minimize corrosion reactions and the oxidizing tendency of the fission process. The $[U^{+4}]/[U^{+3}]$ ratio in the MSRE was maintained at the desired level by reduction of U^{+4} with beryllium metal, and a voltammetric method for the determination of this ratio in the MSRE fuel was developed. The final step in the processing plant will consist in continuously measuring and adjusting the $[U^{+4}]/[U^{+3}]$ ratio of the fuel salt returned to the reactor.

3.3.3.6 Actinide separation and recycle

It appears to be desirable to separate the transuranium actinides and recycle these elements to the reactor for transmutation to less undesirable isotopes in order to minimize difficulties associated with the storage and disposal of wastes containing such materials. A preliminary examination of a recycle flowsheet indicated that actinide separation and recycle should be possible in a processing plant not significantly more complex than the one presently being considered.

3.4 TASK GROUP 2.1 FLOWSHEET ANALYSIS AND DEVELOPMENT

Work in this task group is concerned with computer analyses of processing systems, and the evaluation and development of processing plant flowsheets.

3.4.1 Objective

The objective of this task group is to identify and to develop flowsheets for processing the fuel from a molten-salt reactor which will be optimum with respect to criteria such as practicability, power costs, resource utilization, and environmental effects.

3.4.2 Schedule

The schedule for Task Group 2.1 is shown in Table 3.4.2.

3.4.3 Funding

Operating funds required for Task Group 2.1 are shown in Table 3.4.3.

Table 3.4.2. Schedule for Task Group 2.1 -- Flowsheet analysis and development

	Fiscal year					
	1975	1976	1977	1978	1979	1980
2.1.1 Heat balances		—	—	—		
2.1.2 Mass balances		—	—	—		
2.1.3 Parametric and optimization studies		—				
2.1.4 Waste characterization						
2.1.4.1 Waste types and production rates			—			
2.1.4.2 Waste hazard studies			—			
2.1.5 Processing plant conceptual design and cost estimate			—	—		
2.1.6 Processing system control						
2.1.6.1 Steady state				—		
2.1.6.2 Transients				—		
2.1.6.3 Off-design operation				—		
2.1.6.4 Information required for control					—	
2.1.7 Resource requirements and utilization				—		
2.1.8 Alternate process development		—	—	—		

Table 3.4.3. Operating budget for Task Group 2.1 -- Flowsheet analysis and development
(costs in 1000 dollars)

	Fiscal year					
	1975	1976	1977	1978	1979	1980
2.1.1 Heat balances		10	10	10		
2.1.2 Mass balances		10	10	10		
2.1.3 Parametric and optimization studies		20				
2.1.4 Waste characterization						
2.1.4.1 Waste types and production rates			10			
2.1.4.2 Waste hazard studies			10			
Subtotal 2.1.4			20			
2.1.5 Processing plant conceptual design and cost estimate			75	60		
2.1.6 Processing system control						
2.1.6.1 Steady state				10		
2.1.6.2 Transients				20		
2.1.6.3 Off-design operation				10		
2.1.6.4 Information required for control					70	
Subtotal 2.1.6				40	70	
2.1.7 Resource requirements and utilization				15		
2.1.8 Alternate process development		65	65	65		
Total operating funds for Task Group 2.1		105	180	200	70	

3.4.4 Task 2.1.1 Heat balances

An existing general computer code will be used and additional codes will be developed when necessary to calculate the amount of decay heat release for each operation in the processing plant. This work is necessary to determine the heat transfer area required in each piece of equipment. Codes based upon equilibrium stage models will be modified to allow models in which mass transport effects predominate. In some cases the allowable heat release rate will limit the fission product concentrations because of heat removal considerations. Decay heat generation rates will be obtained from concentration data determined in mass balance calculations.

3.4.5 Task 2.1.2 Mass balances

For the more promising flowsheets, mass balance calculations will be made for each fission product nuclide and for all transuranium isotopes using the computer codes mentioned in the previous section. The mass balance calculations will be coupled with a calculation for the reference reactor design in order that the effect of calculated removal times and the effect of recycle of transuranium isotopes on the reactor performance can be determined. All calculations will be continually updated as new process data (equilibria, mass transfer coefficients, etc.) become available.

3.4.6 Task 2.1.3 Parametric and optimization studies

The computer code which calculates mass balances, heat generation rates, and waste production rates will be used to do parametric studies in order that modifications of the reference flowsheet will reflect an optimization of the effect caused by each characteristic which is studied. Parameters to be varied include reductant concentrations, salt and bismuth flow rates, and modifications to the flowsheet.

3.4.7 Task 2.1.4 Waste characterization

3.4.7.1 Subtask 2.1.4.1 Waste types and production rates

The material balance calculations using the previously mentioned computer codes will be used to describe volumes and compositions of waste streams associated with each proposed flowsheet. Waste disposal considerations associated with each flowsheet will be assessed from these calculations.

3.4.7.2 Subtask 2.1.4.2 Waste hazard studies

For each waste stream, calculations using the computer code ORIGEN will be made to determine the activity and waste hazard as a function of time. This subtask is necessary for evaluating the environmental effects of MSBR operation, and for comparing waste hazards of MSBR's with waste hazards of other reactor concepts.

3.4.8 Task 2.1.5 Processing plant conceptual design and cost estimate

For particularly attractive flowsheets, preliminary plant designs will be performed in which equipment sizes, materials of construction, heat transfer surface areas, line sizes, and pump sizes will be specified. Material balance and heat generation calculations discussed in previous sections will also serve as the basis for these studies in which plant costs will be estimated.

3.4.9 Task 2.1.6 Processing system control

3.4.9.1 Subtask 2.1.6.1 Steady state analyses

An analysis of steady state operation of proposed flowsheets will be done to identify those variables to which the process will be sensitive and to identify possible control methods.

3.4.9.2 Subtask 2.1.6.2 Transient analyses

Once important control variables are identified from steady-state analyses, transient analyses must be performed in order to assess the severity of control problems and to suggest various means for effecting the desired control. Equipment models which accurately describe time-dependent behavior would be developed.

3.4.9.3 Subtask 2.1.6.3 Effects of off-design operation

Off-design operation of the processing plant could result from startup, undetected equipment failure, and control difficulties. The consequences of events such as failure of the fluorinator to remove the required fraction of uranium, increases in mass transfer resistances in salt-metal contactors, changes in flow rates, etc., will be assessed. Actions necessary for return to normal operation will be determined. The effect on breeding performance of prolonged or periodic off-design operation will be assessed.

3.4.9.4 Subtask 2.1.6.4 Information required for control

The analyses described above will identify those variables which must be controlled and the degree of control required. Quantities which can be measured and used as control signals will be identified.

3.4.10 Task 2.1.7 Resource requirements and utilization

The flowsheet analyses which have been discussed will allow the identification of the requirements for all material used in the construction

and operation of an MSBR processing plant. These material requirements will be compared to projections of domestic and world resources and reserves of these materials in order to identify any materials that are likely to limit a growing MSBR industry, and allow for any necessary modification in order to avoid a significant resource limitation.

3.4.11 Task 2.1.8 Alternate process development

The current reference processing flowsheet consists of a sequence of operations, the failure of any one of which has a significant effect on the overall processing efficiency. Moreover, alternatives do not presently exist for most of the processing steps. It is the objective of this task to define alternates for each of the processing steps and, if possible, define a completely new and different processing scheme.

Initially, the effort in this task will be devoted to a thorough review of the pertinent literature relating to the chemistry of protactinium and fission products in molten fluoride salts. Hopefully, ideas for new separations methods will be generated. Concurrently, preliminary laboratory studies of potential sorption and ion-exchange processes will be made. If attractive alternates are defined, they will be emphasized in further work.

3.5 TASK GROUP 2.2 CONTINUOUS FLUORINATOR DEVELOPMENT

This task group covers activities necessary for the development of technology related to the continuous removal of uranium from MSBR fuel salt by contact with elemental fluorine. The initial work is concerned with the development of autoresistance heating methods for simulating heat generation resulting from fission product decay in fluorinators, and with the study of the fluorination chemistry of uranium and other elements which can be oxidized to higher valence states by contact with fluorine. Subsequent work is related to the design, construction and operation of a facility for engineering development and testing of continuous fluorinators. The task group culminates in the design, construction, and operation of a facility for engineering development and testing of equipment in which the removal of uranium from MSBR fuel salt by fluorination and the recombination of uranium with MSBR fuel carrier salt can be carried out simultaneously.

3.5.1 Objective

The objective of this task group is to develop the technology required for the design of fluorinators for the continuous removal of uranium from salt streams in MSBR processing systems.

3.5.2 Schedule

The schedule for Task Group 2.2 is shown in Table 3.5.2.

Table 3.5.2. Schedule for Task Group 2.2 - Continuous fluorinator development

	Fiscal year				
	1975	1976	1977	1978	1979
2.2.1 Nonradioactive heat generation studies	—				
2.2.2 Fluorination chemistry					
2.2.2.1 Uranium removal					
2.2.2.2 Fluorination chemistry of elements other than uranium					
2.2.3 Frozen-wall corrosion studies	—				
2.2.4 Mass transfer in open bubble columns	—				
2.2.5 F ₂ -H ₂ reaction kinetics		—			
2.2.6 Continuous Fluorinator Experimental Facility					
2.2.6.1 Conceptual design and experimental program	—				
2.2.6.2 Final design	—				
2.2.6.3 Fabrication, installation, and testing		—			
2.2.6.4 Operation			—		
2.2.7 Fluorination-Reconstitution Engineering Facility					
2.2.7.1 Conceptual design and experimental program	—				
2.2.7.2 Development required for final design		—			
2.2.7.3 Final design			—		
2.2.7.4 Fabrication, installation, and testing				—	
2.2.7.5 Operation					—

3.5.3 Funding

Operating funds required for Task Group 2.2 are shown in Table 3.5.3. Capital equipment funds are required in the amounts of \$50,000 during FY 1975 for design and construction of the Continuous Fluorinator Experimental Facility and of \$125,000 during FY 1976 for covering one half of the cost of the Fluorination-Reconstitution Engineering Facility. The remaining cost of this facility is covered in Task Group 2.3. Capital equipment funds in the amount of \$75,000 will be required during FY 1976 to provide automatic data-logging equipment for the Fluorination-Reconstitution Engineering Facility.

3.5.4 Facilities

A Continuous Fluorinator Facility is planned for installation in Bldg. 4505 at ORNL. This facility will be used for study and demonstration of continuous fluorination from mid FY 1976 through FY 1977, and will require a capital equipment obligation of \$50,000 in FY 1975. In this facility, a frozen-wall continuous fluorinator would be operated that has a molten zone diameter of 5 in. and a height of about 5 ft. The facility will operate with salt and fluorine flow rates up to 50% of those required in a 1000-MW(e) MSBR.

A Fluorination-Recombination Engineering Facility is planned for installation in Bldg. 7503 at ORNL for study and demonstration of the integrated operations of fluorination and fuel reconstitution using flow rates that are about 50% of those required for a 1000-MW(e) MSBR. The facility will operate from mid-FY 1977 through FY 1978. This facility is also discussed in Task Group 2.3 Fuel Reconstitution under Task 2.3.3 Fluorination-Reconstitution Engineering Facility.

3.5.5 Task 2.2.1 Nonradioactive heat generation studies

The fluorinator will be an open bubble column made of nickel having a frozen layer of salt on the walls to protect against corrosion by fluorine. An internal heat source is necessary for maintaining the frozen salt layer. Fission product decay will provide this heat source in the processing plant, but in initial experiments where no radioactive heat source is available another means must be found. This task would provide a heat source which can be used in nonradioactive experiments to study fluorination in frozen wall fluorinators.

Studies of autoresistance heating must be done to demonstrate the operability of an electrode side arm design on a fluorinator mockup and the ability to maintain stable salt films using the $\text{LiF-BeF}_2\text{-ThF}_4$ salt mixture. Experiments with presently installed equipment indicates that the wall temperature must be held significantly lower than the temperature for which this equipment was designed. Experimental equipment will be designed which will allow external heating and recirculation of

Table 3.5.3. Operating budget for Task Group 2.2 -- Continuous fluorinator development
(costs in 1000 dollars)

	Fiscal year				
	1975	1976	1977	1978	1979
2.2.1 Nonradioactive heat generation studies	30				
2.2.2 Fluorination chemistry					
2.2.2.1 Uranium removal	55	20			
2.2.2.2 Fluorination chemistry of elements other than uranium		50	65	60	
Subtotal 2.2.2	55	70	65	60	
2.2.3 Frozen-wall corrosion studies	20				
2.2.4 Mass transfer in open bubble columns	10				
2.2.5 F ₂ -H ₂ reaction kinetics		70			
2.2.6 Continuous Fluorinator Experimental Facility					
2.2.6.1 Conceptual design and experimental program	15				
2.2.6.2 Final design	73				
2.2.6.3 Fabrication, installation, and testing	5	15			
2.2.6.4 Operation		230	200		
Subtotal 2.2.6	93	245	200		

Table 3.5.3 (continued)

	Fiscal year				
	1975	1976	1977	1978	1979
2.2.7 Fluorination-Reconstitution Engineering Facility					
2.2.7.1 Conceptual design and experimental program	10				
2.2.7.2 Development required for final design	4	40			
2.2.7.3 Final design		30	10		
2.2.7.4 Fabrication, installation, and testing			20		
2.2.7.5 Operation			80	180	
Subtotal 2.2.7	14	70	110	180	
Total operating funds for Task Group 2.2	222	455	375	240	

salt through the fluorinator mockup and forced cooling of the section which will support the frozen salt film. This experiment will also test a method for introducing a salt stream into a fluorinator heated by autoresistance heating.

3.5.6 Task 2.2.2 Fluorination chemistry

The objective of this task is to demonstrate the removal of uranium from MSBR fuel salt and to study the fluorination chemistry of uranium, protactinium, neptunium, plutonium, iodine, and other fission products that will be oxidized to a higher valence state during fluorination. A second objective of this task is to determine the extent to which oxide will be removed from the salt by fluorination.

3.5.6.1 Subtask 2.2.2.1 Uranium removal from fuel salt

The initial objective of this subtask is to confirm the expected ease of removal of uranium from MSBR fuel salt by fluorination to UF_6 . Later objectives are to determine as a function of temperature the kinetics of UF_6 formation and volatilization from the salt. The results of these studies will allow selection of conditions that provide for rapid removal of uranium from the salt with high fluorine utilizations.

3.5.6.2 Subtask 2.2.2.2 Fluorination chemistry of elements other than uranium

The objective of this subtask is to define the behavior during fluorination of elements that are present in the salt only at low concentration. Of particular interest are protactinium, neptunium, plutonium, oxygen and iodine which form volatile fluorides under some conditions. The extent to which such elements form volatile fluorides under optimal conditions for uranium removal will be determined. The oxidation states of these fluorides will be identified, since this knowledge is required in defining the chemistry of the subsequent fuel reconstitution step.

Certain elements (cerium, for example) attain higher oxidation states during fluorination, but the higher-valent fluoride is not volatile. Studies will be made to determine which of the trace elements in the salt are affected in this manner and to determine the ultimate oxidation state of each. The effects of the presence of the higher-valent fluorides on corrosion and on the chemistry of the subsequent reductive extraction step will be assessed.

3.5.7 Task 2.2.3 Frozen wall corrosion protection studies

The objective of this task is to demonstrate that frozen salt films will protect nickel from corrosion in fluorine-molten salt environments.

There are good reasons for believing that frozen salt films will protect against corrosion, but this has not yet been demonstrated. An experiment will be performed in which a frozen salt film is formed on a nickel tube through which fluorine can be sparged into molten salt. This work requires the installation of a fluorine supply system and a fluorine disposal system. Installation of these systems is in progress.

3.5.8 Task 2.2.4 Mass transfer in open bubble columns

The objective of this task is to provide basic design data upon which initial designs of open bubble columns operating with molten-salt systems can be based. Later designs will be based upon this data plus actual operating data obtained with molten-salt systems.

Mass transfer coefficients will be measured in air-aqueous solution systems in order to provide correlations for estimating uranium removal rate and fluorine utilization in the fluorinator. Mass transfer coefficients which are corrected for end effects and for axial dispersion will be measured in glass bubble columns for the bubble flow and the slug flow regimes and for varying physical properties of the liquid phase. End effects are important and methods for estimating the magnitude of end effects will be investigated.

3.5.9 Task 2.2.5 Characterization of the F₂-H₂ reaction

The objective of this work is to provide guidance for the formulation of safety policies concerning areas in the processing plant where fluorine and hydrogen are used in close proximity. The literature will be reviewed for information on the kinetics and explosion (or reaction) limits of the F₂-H₂ reaction. Conditions will be sought under which H₂ and F₂ might form a mixture which might react explosively and destructively if an ignition source were supplied.

Fluorine and hydrogen gases will be mixed in a reaction vessel at low temperatures and pressures. These mixtures will be pressurized at constant temperature or heated at constant pressure until reaction occurs in order to define the limits of spontaneous reaction of mixtures of different compositions. Nonreactive F₂-H₂ mixtures will be exposed to ignition sources of varying types (the presence of atomic fluorine, radiation, spark, light, etc.) in order to determine the effect of ignition source.

3.5.10 Task 2.2.6 Continuous Fluorinator Experimental Facility

The objective of this work is to provide a facility with which continuous frozen-wall fluorinators can be tested.

3.5.10.1 Subtask 2.2.6.1 Definition of experimental program and conceptual design

The work in this subtask will be directed to defining the experimental program and completing the conceptual design for the Continuous Fluorinator Experimental Facility. The experiments carried out in this facility will have the objectives of (1) demonstrating frozen wall corrosion protection in continuous fluorinators, (2) measuring the effect of operating conditions on F_2 utilization, (3) measuring the effect of operating conditions on uranium removal efficiency, and (4) corroborating the correlations derived from air-water measurements. The effect on F_2 utilization and U removal efficiency of the following variables will be measured: gas flow rate, liquid flow rate, temperature, and concentration of UF_4 in the salt. Following the fluorination experiments, the facility will be used to study reconstitution of UF_6 which is mixed with fluorine in order to test methods of fuel reconstitution which do not require separation of the UF_6 and fluorine. Frozen wall corrosion protection will be required.

Equipment for the experiment will include a fluoride salt surge tank, a fluorinator, a salt-hydrogen contactor, UF_6 collection and fluorine disposal systems, means for determining the UF_6 concentration in the fluorinator offgas, and means for sampling the salt streams present in the system. Salt containing UF_4 will be withdrawn from the surge tank and fed to the fluorinator where part of the uranium will be removed as UF_6 . The salt leaving the fluorinator will be fed to the hydrogen-salt contactor for reduction of uranium fluorides to UF_4 before the salt is returned to the surge tank. Salt will be circulated through the system at flow rates in the range 0.3 to 3 liters/min. The fluoride salt surge tank volume (about 5 ft³) is sufficiently large that the uranium concentration in the salt fed to the fluorinator will vary over a useful composition range (approximately 0.35 mole % to 0.00035 mole %) in about 3 hr at a molten salt flow rate of about 1 liter/min. The fluorinator will consist of a 6-in.-OD vessel which will be heated by autoresistance heating using 60-Hz power. The molten salt zone will be about 4.5-in. in diam and the salt depth in the fluorinator will be about 6 ft.

Conceptual design of this facility will consist of a choice of the scale of equipment, identification of auxiliary equipment (gas supplies, excess reagent and waste disposal systems, instrumentation calibration stations, etc.), location of equipment, and preliminary design and layout of equipment.

3.5.10.2 Subtask 2.2.6.2 Final design

The final design of the facility will involve detailed analysis and calculations required to ensure that the facility will meet the desired objectives and that experiments which will be performed will provide the necessary information. Thermal and mechanical stresses will be evaluated and maintained within allowable limits. Instrumentation and control systems will be designed to provide information and necessary control action. The final design will include provisions for equipment maintenance, replacement, or modification.

3.5.10.3 Subtask 2.2.6.3 Fabrication, installation and initial testing

Construction of the facility will be Quality Level III and a quality assurance plan will be prepared in accordance with ORNL quality assurance procedure QA-L-1-104.

Following installation of the facility, the system will be leak checked and salt will be charged to the experiment. Initial testing will include recirculation of salt, formation and maintenance of the frozen wall, and calibration of special instrumentation (salt flow meters, gas chromatographs, etc.). A detailed safety analysis will be prepared before operation of the facility.

Prior to startup detailed check lists will be prepared for the following operations: (1) startup and shutdown of fluorine supply system; (2) startup and shutdown of the fluorine disposal system; (3) operation of instrumentation; (4) salt sampling; (5) operation of the UF₆ disposal system; (6) operation of the hydrogen supply system; (7) formation of frozen salt film; and (8) salt recirculation and drainage.

3.5.10.4 Subtask 2.2.6.4 Operation

The Continuous Fluorination Experimental Facility will be operated during the period from mid FY 1976 to mid FY 1977 in order to develop the technology required for the subsequent design of the Fluorination-Reconstitution Engineering Facility, and to provide improved data on fluorinator performance for processing plant conceptual design and cost estimation studies. Alternate fluorinator designs will be tested as required. Sufficient data will be obtained to show the practicability of frozen-wall fluorinator operation.

3.5.11 Task 2.2.7 Fluorination-Reconstitution Engineering Facility

The objective of this task is to provide a facility in which the operation of a continuous fluorinator and equipment for fuel reconstitution can be integrated in order to determine operating characteristics for the combined steps, to evaluate control methods, and to determine the extent to which surge capacity must be provided between the two operations. Sufficient information will be obtained to allow design of the fluorination-reconstitution systems for the Integrated Process Test Facility as well as for the test reactor mockup.

This facility will allow the testing of fluorinators which will operate under conditions very similar to those expected in a processing plant. The fluorinators in this facility will be designed for much higher uranium removal efficiencies (>99%) than will be possible in the Continuous Fluorinator Experimental Facility (80-90%). The information to be determined from this facility is associated with long-term operability and control of continuous frozen-wall fluorinators. Emphasis will be

placed upon frozen film stability and integrity, accurate corrosion measurements and maintenance of high uranium removal efficiency and fluorine utilization.

The facility will be located in Bldg. 7503 (MSRE Building) and is discussed in detail in Task 2.3.3.

3.6 TASK GROUP 2.3 FUEL RECONSTITUTION

This task group covers activities necessary for the development of technology related to the continuous recombination of MSBR fuel carrier salt and the UF_6 produced by fluorination of fuel salt. The initial work is concerned with the design and operation of small engineering experiments on the recombination operation, and with the study of the recombination chemistry of uranium and other elements which will form volatile fluorides during fluorination. Subsequent work is related to the design and operation of larger engineering experiments on fuel reconstitution. The task group culminates in the design, construction, and operation of a facility for development and testing of equipment in which the removal of uranium from MSBR fuel salt by fluorination and the recombination of uranium with MSBR fuel carrier salt can be carried out simultaneously.

3.6.1 Objective

The objective of this task group is to provide the technology necessary for design of equipment for recombining UF_6 generated in the fluorinators in the processing plant with the processed fuel salt stream returning to the reactor to produce a salt mixture having the proper uranium concentration.

3.6.2 Schedule

The schedule for this task group is shown in Table 3.6.2.

3.6.3 Funding

Operating funds required for Task Group 2.3 are shown in Table 3.6.3. The operating fund requirements for Task 2.3.3 have been shared with Task 2.2.7, since this is the same facility. Capital equipment funds are required in the amounts of \$5,000 during FY 1975 for gas density cells for HF and UF_6 analyses in Task 2.3.2, and of \$125,000 during FY 1976 to cover one half of the cost for designing and constructing the Fluorination-Reconstitution Engineering Facility. The remaining cost of this facility is covered in Task Group 2.2.

Table 3.6.2. Schedule for Task Group 2.3 - Fuel reconstitution

	Fiscal year				
	1975	1976	1977	1978	1979
2.3.1 Fuel reconstitution chemistry					
2.3.1.1 Uranium chemistry					
2.3.1.2 Chemistry of other volatile fluorides					
2.3.2 Engineering studies of fuel reconstitution					
2.3.3 Fluorination-Reconstitution Engineering Facility					
2.3.3.1 Conceptual design and experimental program					
2.3.3.2 Development for final design					
2.3.3.3 Final design					
2.3.3.4 Fabrication installation and testing					
2.3.3.5 Operation					

Table 3.6.3. Operating budget for Task Group 2.3 — Fuel reconstitution
(costs in 1000 dollars)

	Fiscal year				
	1975	1976	1977	1978	1979
2.3.1 Fuel reconstitution chemistry					
2.3.1.1 Uranium chemistry	55	30			
2.3.1.2 Chemistry of other volatile fluorides		20	65	55	
Subtotal 2.3.1	55	50	65	55	
2.3.2 Engineering studies of fuel reconstitution	90	139			
2.3.3 Fluorination-Reconstitution Engineering Facility					
2.3.3.1 Conceptual design and experimental program	5				
2.3.3.2 Development for final design	2	40			
2.3.3.3 Final design		30	10		
2.3.3.4 Fabrication installation and testing			15		
2.3.3.5 Operation			80	180	
Subtotal 2.3.3	7	70	105	180	
Total operating funds for Task Group 2.3	152	259	170	235	

3.6.4 Facilities

A Fluorination-Reconstitution Engineering Facility is planned for installation in Bldg. 7503 for study and demonstration of the integrated operations of fluorination and reconstitution using flow rates that are about 50% of those required for processing a 1000-MW(e) MSBR. The facility will operate from late FY 1977 through FY 1978. This facility interfaces with Task Group 2.2, Continuous Fluorinator Development.

3.6.5 Task 2.3.1 Fuel reconstitution chemistry

The objective of this task is to determine the fuel reconstitution chemistry of uranium and other elements which form volatile fluorides during fluorination including neptunium, plutonium, and iodine.

3.6.5.1 Subtask 2.3.1.1 Uranium chemistry

The objective of this subtask is to elucidate the chemistry of the reactions of gaseous UF_6 and fluorine with UF_4 dissolved in MSBR fuel salt and the subsequent reduction of the product UF_5 by hydrogen. Previous work has shown that the primary reactions are

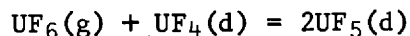

and



but that some UF_5 is volatilized from the melt according to

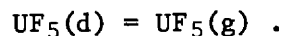

Estimates of the equilibrium constant for these reactions will be made to aid in the design of engineering-scale equipment for fuel reconstitution studies.

Previous work has also shown that the reaction

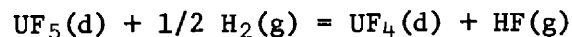

is slower than the UF_6 absorption reactions. Information on the kinetics of this reaction will be obtained. Of particular interest are the determination of the rate-controlling step and the effect of temperature on the reaction rate.

3.6.5.2 Subtask 2.3.1.2 Chemistry of other volatile fluorides

The objective of this subtask is to elucidate the chemistry of such volatile fluorides as NpF_6 , PuF_6 , OF_2 and IF_7 in the fuel reconstitution step.

The initial work will establish whether dissolved UF_4 reduces the gaseous species NpF_6 and IF_7 ; if so, the stoichiometries and equilibrium constants for the reactions will be determined. The oxidation state of the reduced iodine species will be of special interest since this species will be present in the subsequent step in which hydrogen is used to reduce dissolved UF_5 . Some attention will be paid to the fate of such noble metal fluorides as MoF_6 which should be reduced to a lower-valent fluoride by dissolved UF_4 , and possibly would be reduced to the metallic state during the hydrogen reduction of UF_5 . The extent to which oxygen is introduced into the fuel salt during reconstitution via reactions involving OF_2 will also be determined.

3.6.6 Task 2.3.2 Engineering studies of fuel reconstitution

The objective of this task is to study the absorption of UF_6 by salt containing UF_4 and to study the reduction of the resulting UF_5 to UF_4 with hydrogen in an engineering system on a scale which will allow sufficient engineering design data to be obtained to design the Fluorination-Reconstitution Engineering Facility. These tests will require a molten salt metering system, a UF_6 supply and metering system, a UF_6 disposal system, a hydrogen supply, an HF disposal system, and devices for measuring UF_6 and HF concentration in gas streams. The use of gold plated or gold-lined equipment for corrosion protection will be investigated. Studies are planned in a 1-in.-ID combined absorption-reduction system having the shape of a U-tube. The hydrogen reduction side of the U-tube determines the overall height of the column, which will be about 10 ft. Salt flow rates up to 300 cc/min, H_2 flow rates up to 720 std cc/min, and UF_6 flow rates up to 360 std cc/min will be investigated. Reconstitution experiments in which the UF_6 is associated with fluorine, as would be the case from an actual fluorinator, will be carried out in the Continuous Fluorinator Experimental Facility. Frozen wall corrosion protection would be required in this case.

3.6.7 Task 2.3.3 Fluorination-Reconstitution Engineering Facility

The objective of this task is to provide a facility in which the operation of a continuous fluorinator and equipment for fuel reconstitution can be integrated in order to determine operating characteristics for the combined steps, to evaluate control methods, and to determine the extent to which surge capacity must be provided between the two operations. Sufficient information will be obtained to allow design of fluorination-reconstitution systems for the Integrated Process Test Facility and for the test reactor mockup.

3.6.7.1 Subtask 2.3.3.1 Definition of experimental program and conceptual design

The reconstitution experiments carried out in this facility will have the following objectives: (1) to determine if uranium losses can occur during long-term operation, (2) to test the effects of using recycle streams in the reconstitution step, (3) to determine the need for surge capacity between operations, (4) to determine long-term corrosion rates, and (5) to test operability of combined processes. This facility will be located in Bldg. 7503 (MSRE Building). Conceptual design will consist of a choice of the scale of the equipment, identification of auxiliary equipment (gas supplies, excess reagent and waste disposal systems, instrumentation calibration stations, etc.), and preliminary design and layout of equipment consistent with experimental objectives. The areas which will require development work before completing the final design will be identified.

3.6.7.2 Subtask 2.3.3.2 Development work required for final design

Plans for required development will be detailed, and schedules determined which are consistent with the overall schedule for this task.

3.6.7.3 Subtask 2.3.3.3 Final design

The final design of the facility will involve detailed analyses and calculations required to ensure that the facility will meet the objectives and that experiments which will be performed in it will provide the necessary information. Thermal and mechanical stresses will be maintained within allowable limits. Instrumentation and control systems will be designed to provide information and necessary control action. The final design will include provisions for equipment maintenance, replacement, or modification.

3.6.7.4 Subtask 2.3.3.4 Fabrication, installation, and initial testing

Construction of the facility will be to Quality Level III standards and a quality assurance plan will be prepared in accordance with ORNL quality assurance procedure QA-L-1-104.

Following installation of the facility, the system will be leak checked and salt will be charged to the experiment. Initial testing will include recirculation of salt at rates up to the design limit, formation of frozen walls where required, and calibration of special instrumentation (salt flow meters, gas chromatographs, etc.). A detailed safety analysis will be prepared.

Prior to startup detailed check lists will be prepared for the following operations: (1) startup and shutdown of the fluorine supply system;

(2) startup and shutdown of the fluorine disposal system; (3) operation of instrumentation; (4) salt sampling; (5) operation of the hydrogen supply system; (6) formation of frozen salt film; and (7) salt recirculation and drainage.

3.6.7.5 Subtask 2.3.3.5 Operation

The Fluorination-Reconstitution Engineering Facility will be operated from late FY 1977 through FY 1978 in order to develop the technology required for the subsequent design of the associated portions of the Integrated Process Test Facility, and to provide improved data on fluorination and reconstitution equipment performance for processing plant conceptual design and cost estimation studies. Alternate equipment designs for the primary operations of fluorination and reconstitution will be tested as required. Sufficient information will be obtained to show the practicability of the combined fluorination-reconstitution steps.

3.7 TASK GROUP 2.4 PROTACTINIUM REMOVAL

This task group covers activities necessary for the development of technology related to the removal of protactinium from MSBR fuel salt by selective extraction into liquid bismuth containing reductant. The initial work is concerned with study of mass transfer and hydrodynamics in salt-metal contactors, and with the development of equipment for hydrofluorinating or hydrochlorinating molten salts in the presence of liquid bismuth. Subsequent work is related to the design, construction, and operation of a facility for engineering development and testing of components necessary for protactinium removal. The task group culminates in the design, construction, and operation of a small engineering experiment that will use representative concentrations of ^{231}Pa (an energetic alpha emitter) for demonstrating all steps in the protactinium removal operation.

3.7.1 Objective

The objective of this task group is to develop the technology necessary for designing systems for removing protactinium from the fuel salt in order to allow it to decay to ^{233}U outside the reactor.

3.7.2 Schedule

The schedule for carrying out Task Group 2.4 is shown in Table 3.7.2.

Table 3.7.2. Schedule for Task Group 2.4 - Protactinium removal

	Fiscal year					
	1975	1976	1977	1978	1979	1980
2.4.1 Salt-metal contactor development						
2.4.1.1 Mass transfer studies with salt-metal	—					
2.4.1.2 Hydrodynamics and mass transfer studies	—					
2.4.2 Engineering studies of hydrofluorination and hydrochlorination		—				
2.4.3 Reductive Extraction Process Facility						
2.4.3.1 Conceptual design and experimental program	—					
2.4.3.2 Development for final design		—				
2.4.3.3 Final design			—			
2.4.4.4 Fabrication, installation, and testing				—		
2.4.3.5 Operation				—		
2.4.4 Protactinium Isolation Demonstration Experiment						
2.4.4.1 Modification of cell 2		—				
2.4.4.2 Conceptual design and experimental program		—				
2.4.4.3 Development for final design			—			
2.4.4.4 Final design				—		
2.4.4.5 Fabrication, installation, and testing				—		
2.4.4.6 Operation					—	
2.4.4.7 Equipment disposal and Pa recovery						—

3.7.3 Funding

Operating funds required for Task Group 2.4 are shown in Table 3.7.3. Capital equipment funds will be required in the amounts of \$190,000 in FY 1976 for the Reductive Extraction Process Facility (Task 2.4.3), and \$400,000 in FY 1977 for the Protactinium Isolation Demonstration Experiment (Task 2.4.4).

The program will require alpha containment space for the Protactinium Isolation Demonstration Experiment. This space will be provided by converting cell 2, Bldg. 3019, into a multilevel alpha facility. GPP funds in the amount of \$355,000 will be required in early FY 1976 for this modification.

3.7.4 Facilities

The Salt/Bismuth Flow-Through Facility is an existing facility for studying various types of contactors for reductive extraction of ^{237}U and ^{97}Zr from molten salt into molten bismuth, and for studying hydro-fluorination of bismuth in the presence of molten salt. This facility is located in Bldg. 3592 and will operate through FY 1975.

A Reductive Extraction Process Facility will be installed in Bldg. 7503 for study and demonstration of all steps of protactinium removal with flow rates that are 25% of those required for a 1000-MW(e) MSBR. This facility will operate from early FY 1977 to mid FY 1978. A capital equipment obligation of \$190,000 is required in FY 1976 for construction of this facility.

A Protactinium Isolation Demonstration Experiment would be installed in Cell 2 in Bldg. 3019 to demonstrate all process steps for the removal from fuel salt using representative concentrations of protactinium. This demonstration will begin in late FY 1977 and end in early FY 1979. A capital equipment obligation of \$400,000 is required during FY 1977.

3.7.5 Task 2.4.1 Salt-metal contactor development

The objective of this task is to provide the technology required for designing equipment for contacting molten salt and molten bismuth in order to carry out the transfer of protactinium from salt streams into bismuth streams. The equipment which is developed must not be unreasonably large; and must not be expensive to fabricate.

3.7.5.1 Subtask 2.4.1.1 Mass transfer in a stirred interface contactor

Measurement of mass transfer rates of ^{237}U and ^{97}Zr tracers between fluoride fuel carrier salt and bismuth will be continued in a nondispersed stirred interface contactor installed in the Salt/Bismuth Flow-Through Facility. These results will permit the evaluation of contactors of

Table 3.7.3. Operating budget for Task Group 2.4 - Protactinium removal
(costs in 1000 dollars)

	Fiscal year					
	1975	1976	1977	1978	1979	1980
2.4.1 Salt-metal contactor development						
2.4.1.1 Mass transfer studies with salt-metal	30					
2.4.1.2 Hydrodynamics and mass transfer studies	5					
Subtotal 2.4.1	35					
2.4.2 Engineering studies of hydrofluorination and hydrochlorination	20	50				
2.4.3 Reductive Extraction Process Facility						
2.4.3.1 Conceptual design and experimental program	48					
2.4.3.2 Development for final design	81	35				
2.4.3.3 Final design		65				
2.4.3.4 Fabrication, installation, and testing		40	30			
2.4.3.5 Operation			170	105		
Subtotal 2.4.3	129	140	200	105		
2.4.4 Protactinium Isolation Demonstration Experiment						
2.4.4.1 Modification of cell 2		16				
2.4.4.2 Conceptual design and experimental program	25					
2.4.4.3 Development for final design	10	90				
2.4.4.4 Final design		70	35			
2.4.4.5 Fabrication, installation, and testing			70			

Table 3.7.3 (continued)

	Fiscal year					
	1975	1976	1977	1978	1979	1980
2.4.4.6 Operation			100	240		
2.4.4.7 Equipment disposal and Pa recovery				15	25	
Subtotal 2.4.4	35	176	205	255	25	
Total operating funds for Task Group 2.4	219	366	405	360	25	

this type for MSBR processing systems. A sufficient range of flow rates, distribution coefficients, etc., will be used to allow testing of a general design relation.

3.7.5.2 Subtask 2.4.1.2 Hydrodynamics and mass transfer in stirred interface contactors

Development of correlations for predicting mass transfer rates and dispersion of phases in stirred interface contactors of the Lewis type will be continued. Experiments with aqueous-mercury systems will be conducted to measure mass transfer coefficients in metal and aqueous phases. The effect of physical property variations will be investigated. Improved methods for predicting the conditions under which the phases are dispersed will be developed. Mechanically agitated contactors in which the phases are dispersed will be developed for use with LiCl-Bi contactors where bismuth entrainment in the salt will not be a problem.

3.7.6 Task 2.4.2 Engineering studies of hydrofluorination and hydrochlorination in salt-bismuth systems

The objective of this task is to provide the three phase (two-liquid phases and a gas phase) contactors which will be required for oxidizing materials from bismuth streams to return them to salt streams. Such operations will be required for the HF-fluoride salt-bismuth system in the reference processing flowsheet, and for the HCl-chloride salt-bismuth system for flowsheets under consideration for actinide recycle.

Following the salt-metal contactor studies in the Salt/Bismuth Flow-Through Facility, this facility will be modified to allow testing and development of the required three-phase hydrofluorinators.

Design, installation, and operation of an experimental hydrofluorinator for use with the fluoride salt-bismuth system is planned. This system will allow for the measuring of rates of hydrofluorination of materials from the bismuth phase to the fluoride salt phase and for obtaining sufficient information for the subsequent design of a hydrofluorinator for the Reductive Extraction Process Facility (Task 2.4.3). This hydrofluorinator will use either HF or H₂-HF mixtures. Experience gained in the operation of this equipment will permit the design of a hydrochlorinator for use with chloride salts.

3.7.7 Task 2.4.3 Reductive Extraction Process Facility

The objectives of this task are: (1) to conduct engineering experiments to measure mass transfer data in contactors of sufficient size and with sufficient accuracy to be used in the design of processing plant components and in the subsequent design of associated portions of the Integrated Process Test Facility, (2) to advance the technology of manipulating

molten salt and bismuth in engineering equipment, and (3) to advance the technology of fabrication of equipment suitable for use in an MSBR processing system.

3.7.7.1 Subtask 2.4.3.1 Definition of program and conceptual design

The reductive extraction process facility will allow testing and development of equipment of a design suitable for use in a full-scale protactinium removal process. The facility will operate continuously and will be used to develop multi-stage salt-bismuth contactors, salt-bismuth hydrofluorinators, methods for reductant addition, and other equipment items. An experimental program will be defined to accomplish these objectives.

Conceptual design of this facility will consist of a choice of the scale of the equipment, identification and design of auxiliary equipment (gas supplies, excess reagent and waste disposal systems, instrumentation calibration stations, etc.), and preliminary sketching and layout of equipment. This facility will be installed in Bldg. 7503.

3.7.7.2 Subtask 2.4.3.2 Development work required for final design

Components of this facility which require further development before the final design include the following: (1) a continuous hydrofluorinator, (2) mechanical joints between molybdenum and graphite components, (3) salt and bismuth pumps, and (4) a device for continuous reductant addition. These components will be designed and tested to the extent necessary before incorporation into the final design.

3.7.7.3 Subtask 2.4.3.3 Final design

The final design of the facility will involve detailed analysis and calculations required to ensure that the facility will meet the program objectives and that experiments which will be performed in it will provide the necessary information. Thermal and mechanical stresses will be maintained within allowable limits. Instrumentation and control systems will be designed to provide information and necessary control action. The final design will include provisions for equipment maintenance, replacement, or modification.

3.7.7.4 Subtask 2.4.3.4 Fabrication, installation, and testing

Construction of the facility will be to Quality Level III standards and a quality assurance plan will be prepared in accordance with ORNL quality assurance procedure QA-L-1-104.

Following installation of the facility the system will be leak checked, and the salt and bismuth will be charged to the system and will be

purified by circulation through the hydrofluorinator. Initial testing will include this operation and the calibration of special instrumentation (salt and bismuth flowmeters and interface detectors).

3.7.7.5 Subtask 2.4.3.5 Operation

Prior to initial testing and startup detailed check lists will be prepared for the following operations: (1) startup and shutdown of HF supply system; (2) startup and shutdown of the HF disposal system; (3) operation of instrumentation; (4) salt and bismuth sampling; (5) salt and bismuth recirculation; (6) reductant addition; (7) hydrofluorinator operation; and (8) salt and bismuth drainage.

The REPF will operate continuously and be used to develop multistage salt-bismuth contactors, salt-bismuth hydrofluorinators, and other required equipment items. Data will be obtained on materials of construction, corrosion, the rate of mass transfer of uranium, zirconium, thorium, and lithium between salt and bismuth phases and other data required for evaluation and design of protactinium removal systems. Sufficient information will be obtained for the subsequent design of the associated portions of the Integrated Process Test Facility (Task Group 2.9).

3.7.8 Task 2.4.4 Protactinium Isolation Demonstration Experiment

The objective of this experiment is to demonstrate with representative concentrations of protactinium the process for removing Pa from fuel salt. The process is based upon data from small equilibrium experiments using Pa at the tracer level and upon extrapolations of results from engineering experiments which did not actually use Pa. Completion of this task is complicated by the fact that no stable isotope of Pa exists and the resulting experiments must be conducted with ^{231}Pa which is an energetic alpha emitter which requires special containment and operating considerations.

3.7.8.1 Subtask 2.4.4.1 Modification of Cell 2, Bldg. 3019

A large laboratory area capable of containing high level alpha activity is required for the demonstration. Cell 2 in Bldg. 3019 will be converted into two alpha laboratory spaces in which MSBR fuel processing experiments involving alpha-emitting materials, specifically protactinium, will be conducted. This conversion will include extensive modification of the present facilities including new flooring, a new hot change room, modification of the present ventilation system, and new utilities.

3.7.8.2 Subtask 2.4.4.2 Program definition and conceptual design

A review of the development program and identification of areas requiring development will be completed. This will include locating and obtaining sufficient quantities of protactinium for experimental purposes. Upon determination of the amount of protactinium available, a flowsheet and preliminary layout of equipment will be completed.

3.7.8.3 Subtask 2.4.4.3 Development work required for final design

Prototypes of the necessary experimental equipment will be designed, constructed, and tested prior to the final design of the Protactinium Isolation Demonstration Experiment.

3.7.8.4 Subtask 2.4.4.4 Final design

Final design, detailed flowsheet, and final equipment layout for the Protactinium Isolation Demonstration Experiment to be installed in Cell 2 of Bldg. 3019 will be completed. A detailed safety analysis will be prepared.

3.7.8.5 Subtask 2.4.4.5 Installation and initial testing

Fabrication of experimental equipment will be completed and the equipment will be installed and tested before protactinium is added to the system.

3.7.8.6 Subtask 2.4.4.6 Operation

Detailed check lists for all operations will be prepared. This experiment will be operated continuously from late FY 1977 to late FY 1978. These experiments will corroborate protactinium removal flowsheets which were developed solely from chemical laboratory data and extrapolations from engineering experiments in which no Pa was used.

3.7.8.7 Subtask 2.4.4.7 Equipment disposal and protactinium reclamation

The protactinium will be recovered from the experimental equipment in a form which will be convenient for storage and reuse, probably as a reduced form in Li-Bi alloy. The process will be designed for this recovery as the final step. The equipment will be decontaminated or removed and the facility will be decontaminated.

3.8 TASK GROUP 2.5 RARE-EARTH REMOVAL

This task group covers activities necessary for the development of technology related to the removal of rare-earth fission products from MSBR fuel carrier salt by selective extraction into liquid bismuth containing reductant and transfer to molten LiCl. The initial work is concerned with study of mass transfer and hydrodynamics in salt-metal contactors, and with operation of an engineering experiment that uses salt and bismuth flow rates that are about 1% of those required for processing a 1000-MW(e) MSBR. The task group culminates in the design, construction and operation of a facility for engineering development and testing of components necessary for rare-earth removal that will use salt and bismuth flow rates which are about 10% of those required for a 1000-MW(e) MSBR.

3.8.1 Objective

The objective of this task is to develop the technology required for design of equipment for separating the rare-earth fission products from MSBR fuel salt.

3.8.2 Schedule

The schedule for execution of Task Group 2.5 is shown in Table 3.8.2.

3.8.3 Funding

Operating funds required for Task Group 2.5 are shown in Table 3.8.3. Obligation of capital equipment funds in the amount of \$200,000 will be required during FY 1976 for construction of the Metal Transfer Process Facility.

3.8.4 Facilities

The Metal Transfer Process Facility would be located in the high bay area of Bldg. 7503. This facility will be used for study and demonstration of the metal transfer process for rare-earth removal with flow rates which are about 10% of those required in a 1000-MW(e) MSBR. This facility will operate continuously from early FY 1977 to mid FY 1978.

An existing facility, the Salt/Bismuth Flow-Through Facility, located in Bldg. 3592 is currently being used to test mechanically agitated non-dispersing salt-bismuth contactors.

Table 3.8.2. Schedule for Task Group 2.5 - Rare earth removal

	Fiscal year				
	1975	1976	1977	1978	1979
2.5.1 Metal transfer experiment MTE-3B					
2.5.2 Salt-metal contactor development					
2.5.2.1 Hydrodynamics					
2.5.2.2 Mass transfer					
2.5.2.3 Removal of interfacial solids					
2.5.3 Metal Transfer Process Facility					
2.5.3.1 Conceptual design and experimental program					
2.5.3.2 Development for final testing					
2.5.3.3 Final design					
2.5.3.4 Fabrication, installation, and testing					
2.5.3.5 Operation					

Table 3.8.3. Operating budget for Task Group 2.5 -- Rare-earth removal
(costs in 1000 dollars)

	Fiscal year				
	1975	1976	1977	1978	1979
2.5.1 Metal transfer experiment MTE-3B	160				
2.5.2 Salt-metal contactor development					
2.5.2.1 Hydrodynamics	5				
2.5.2.2 Mass transfer	5				
2.5.2.3 Removal of interfacial solids	10				
Subtotal 2.5.2	20				
2.5.3 Metal Transfer Process Facility					
2.5.3.1 Conceptual design and experimental program	5				
2.5.3.2 Development for final design	15	35			
2.5.3.3 Final design	8	15			
2.5.3.4 Fabrication, installation, and testing		105			
2.5.3.5 Operation			180	150	
Subtotal 2.5.3	28	155	180	150	
Total operating funds for Task Group 2.5	208	155	180	150	

3.8.5 Task 2.5.1 Metal transfer experiment MTE-3B

Metal transfer experiment MTE-3B is of similar design to experiment MTE-3, which was an engineering scale experiment using salt and bismuth flow rates that were about 1% of the estimated flow rates required for processing a 1000-MW(e) reactor. The rates of transfer of rare earths between the three salt and metal phases in experiment MTE-3 ranged between 10 and 30% of the rates predicted by literature correlations.

The study of mass transfer rates of rare earths in MTE-3B will be continued. Mass transfer rates will be compared with literature and other correlations being developed. In addition, the long-term stability of the transfer rates, the effect of solids accumulation at the salt-metal interfaces on transfer rates, and the effect of rare-earth concentrations on transfer rates will be investigated.

3.8.6 Task 2.5.2 Salt-metal contactor development

The objective of this task is to develop the technology necessary for designing equipment for contacting molten salt and molten bismuth in order to carry out the transfer of rare earths from salt streams into bismuth streams. This task interfaces with Task 2.4.1, Salt-Metal Contactor Development.

3.8.6.1 Subtask 2.5.2.3 Removal of interfacial solids

One possible reason for the lower than expected rare-earth transfer rates observed in MTE-3 could be that air and/or moisture entered the equipment (in spite of careful operation to prevent such contamination) and reacted with the salts, metals, or other constituents to form insoluble oxides, etc. These materials would collect at the interfaces to perhaps form a thin film and be a barrier to material transfer. Means to remove any such films during operation of metal transfer process equipment will be developed.

3.8.7 Task 2.5.3 Metal Transfer Process Facility

The objective of this task is to provide a facility for testing and development of equipment of a design suitable for use in a full-scale process for removal of rare earths from a MSBR fuel carrier salt. Experiments will be carried out in the facility to develop multistage salt-bismuth contactors as well as other required equipment which will provide data on the rate of removal of rare earths from the fuel carrier salt and evaluate the suitability of materials of construction and long-term reliability of system components. Provisions for maintenance of process equipment and removal of system components for modification, repair or installation of equipment of alternate design will be included in the design of the facility.

The facility will be located in the high bay area of Bldg. 7503 and will require the installation of purified HF, H₂, and Ar supply systems. Initially the facility will be used for Metal Transfer Experiment MTE-4 with salt and metal flow rates 5 to 10% of those required for a 1000-MW(e) MSBR.

3.8.7.1 Subtask 2.5.3.1 Definition of experimental program and conceptual design

The experimental program to be conducted during Metal Transfer Experiment MTE-4, which will be carried out in the Metal Transfer Process Facility, includes the following objectives:

1. demonstration of the removal of rare-earth fission products from MSBR fuel carrier salt and accumulation of these materials in a lithium-bismuth solution in equipment of a significant size;
2. determination of mass transfer coefficients between mechanically agitated salt and bismuth phases;
3. determination of the rate of removal of rare earths from the fluoride salt in multistage equipment;
4. evaluation of potential materials of construction, graphite in particular;
5. testing of mechanical devices, such as pumps and agitators, that will be required in a processing plant; and
6. development of instrumentation for measurement and control of process variables such as salt-metal interface location, salt flow rate, and salt or bismuth liquid level.

The proposed metal transfer process facility consists basically of the following systems: (1) a fluoride salt system with which molten fluoride salt containing rare-earth fluorides can be circulated at a controlled rate through a salt-metal contactor, (2) a salt-metal contactor in which the rare earths are extracted from the fluoride salt and transferred to a stream of molten LiCl, (3) a LiCl system for circulating the LiCl at a controlled rate between the salt-metal contactor and a Li-Bi stripper where the rare earths are removed from the LiCl and deposited in a bismuth solution containing from 5 to 50 at. % Li, (4) a salt-metal hydro-fluorinator for removing oxide impurities from the salt and metal or for returning the rare earths from the Li-Bi solution to the fluoride salt after a run has been completed, and (5) drain and waste tanks for storing salt and bismuth that are removed from the system. The system will contain provisions for sampling the salt and bismuth phases in each vessel and for sampling the salt streams from the salt-metal contactor.

The principal equipment items are the fluoride salt surge tank, which has a volume of about 300 liters and will consist of a carbon steel liner in a stainless steel vessel; a three-stage salt-metal contactor made of graphite and enclosed in a stainless steel containment vessel; a stainless steel vessel having a graphite or carbon-steel liner in which rare earths will be accumulated in a lithium-bismuth solution having a volume of about 100 liters; and a hydrofluorinator that has a volume of about 150 liters and consists of a graphite crucible enclosed in a stainless steel vessel. Conceptual designs for this equipment will be completed.

3.8.7.2 Subtask 2.5.3.2 Development work required for final design

Development work and further evaluation of existing process equipment required before the final design of the facility can be completed are:

1. Design criteria from the standpoint of ease of fabrication and accepted design technology for graphite vessels.
2. Instrumentation for measurement and control of process variables such as salt-metal interface locations, salt flow rates, and salt and bismuth liquid level.
3. Pumps required to circulate the salts (fuel carrier salt and LiCl). Check valve pumps were used satisfactorily in Metal Transfer Experiment MTE-3; however, centrifugal salt pumps of the type developed at ORNL for use in forced circulation salt loops may have advantages.

3.8.7.3 Subtask 2.5.3.3 Final design

The final design of the facility will involve detailed analysis and calculations required to ensure that the facility will meet the program objectives. The adequacy of the containment of the hazardous materials such as beryllium and thorium at elevated temperatures, radioactive rare-earth tracers and HF and H_2 gases require careful attention. Thermal and mechanical stresses need to be evaluated and maintained within allowable limits. The final design will take into account the planned operating procedures so that these are not unduly difficult. Instrumentation and control systems will provide information and control actions necessary to maintain the specified operating conditions, take corrective action, as needed, if operating limits (temperature, pressure, flow rates, etc.) are exceeded, and operating data required to evaluate experimental results.

Further, the final design will include provisions for equipment maintenance, replacement, or modification.

3.8.7.4 Subtask 2.5.3.4 Fabrication, installation, and initial testing

Construction of the facility will be Quality Level III and a quality assurance plan will be prepared in accordance with ORNL quality assurance procedure QA-L-1-104.

Gas supply systems to provide purified HF, H₂, and Ar will be installed in Bldg. 7503. An emergency electric power system consisting of a 300-kVA, 480-V, three-phase diesel-driven motor-generator will be used to provide sufficient power to maintain experiment operating conditions and prevent salt freezing in the event of loss of normal building power.

After installation of Metal Transfer Experiment MTE-4, the entire system will be pressure tested to ensure that it is leak tight and then treated with hydrogen at 650°C to reduce any oxides on the interior surfaces of the vessels. After the hydrogen treatment has been completed, the system will be flushed with argon and maintained under an argon atmosphere to prevent entry of air and moisture.

All heater, instrumentation, and control circuits will be checked for proper operation. Calibration of temperature and pressure indicators and controllers will be performed and documented.

Prior to startup and initial operation of experiment MTE-4, detailed operating procedures for all phases of operation will be written. These will include: (1) heatup of the MTE-4 system, (2) bismuth purification and addition, (3) fuel carrier salt purification and addition, (4) Li-Bi preparation and addition, (5) LiCl purification and addition, (6) salt and bismuth sampling, (7) system shutdown (normal and emergency), (8) draining of salts and bismuth, and (9) addition of rare earths to system.

After the hydrogen treatment has been completed the system will be flushed with argon, and salt and metal will be charged to the individual vessels. Fluoride salt that has previously been purified will be transferred as a liquid into the fluoride salt storage tank. Bismuth that has previously been purified by treatment with hydrogen will be charged in molten form to the salt-metal contactor. Initially, the Li-Bi solution for the Li-Bi stripper may be prepared either in the Li-Bi stripper or in the salt-and-metal hydrofluorination vessel to remove oxide impurities before it is transferred to the Li-Bi stripper. All of these operations have been carried out successfully on a smaller scale in previous experiments.

After the salt and metal phases have been charged to the system, the LiCl and fluoride salt pumps and flow meters will be tested and calibrated. To test the fluoride salt system, salt will be circulated from the fluoride salt storage vessel to the salt-metal contactor and back to the fluoride salt storage vessel. The LiCl pump and flow meter will be tested and calibrated by circulating LiCl from the Li-Bi stripper to the salt-metal contactor, and back to the Li-Bi stripper. The system will then be ready to begin normal operation.

3.8.7.5 Subtask 2.5.3.5 Operation

Operation of Metal Transfer Experiment MTE-4 will begin with the addition of rare-earth fluorides to the fluoride storage tank. Both stable rare earths and tracer quantities of radioactive rare earths will be added. During operation, the rate of removal of rare earths from the fluoride salt and the concentration of rare earths at points throughout the system will be determined by periodically taking samples of the various phases. This data will permit evaluation of the effectiveness of salt-metal contactors of various designs for transferring rare earths between the salt and metal phases. The length of an experiment will vary up to about a week depending on the operating conditions and the rare earths used. After a run has been completed, the system will be prepared for the next run either by adding additional rare earths to the fluoride salt storage tank and reductant (lithium) to the Li-Bi stripper or the rare earths used in the previous run can be transferred from the Li-Bi solution to the fluoride salt by treating the two phases with HF in the salt-metal hydrofluorination vessel.

Normally, the system will be kept at operating temperature between runs with the normal charge of salt and metal in the system. For replacement of the salt-metal contactor, the salt and bismuth will be drained from the contactor into a drain tank. The salt-metal contactor and connecting lines will be cooled to room temperature for maintenance or replacement. Freeze valves and argon purges will be used to prevent air and moisture from entering the remaining vessels when the lines to the contactor are opened. During a complete shut down, salt and metal will be drained from the salt-metal contactor, the Li-Bi stripper, and the salt-and-metal hydrofluorination vessel into drain tanks before these vessels are cooled down, since freezing of salt or bismuth in these vessels could cause damage to the graphite or molybdenum liners. The salt will remain in the fluoride salt storage vessel during a shutdown for maintenance.

3.9 TASK GROUP 2.6 FUEL SALT PURIFICATION

3.9.1 Objective

The purpose of this task group is to develop the technology for purifying the processed fuel salt of bismuth and corrosion products and adjusting the valence of uranium before the salt is returned to the reactor.

3.9.2 Schedule

The schedule for this task group is shown in Table 3.9.2.

3.9.3 Funding

Operating funds required for this task group are shown in Table 3.9.3. Capital equipment funds in the amount of \$25,000 will be required during FY 1977 for a computerized voltammeter to allow $[U^{3+}]/[U^{4+}]$ measurements.

Table 3.9.2. Schedule for Task Group 2.6 -- Fuel salt purification

	Fiscal year			
	1975	1976	1977	1978
2.6.1 Uranium valence adjustment				
2.6.2 Bismuth removal				
2.6.2.1 Removal of entrained bismuth				
2.6.2.2 Removal of soluble bismuth				

Table 3.9.3. Operating budget for Task Group 2.6 -- Fuel salt purification (costs in 1000 dollars)

	Fiscal year				
	1975	1976	1977	1978	1979
2.6.1 Uranium valence adjustment		10	60	60	
2.6.2 Bismuth removal					
2.6.2.1 Removal of entrained bismuth		10			
2.6.2.2 Removal of soluble bismuth		25	15	15	
Subtotal 2.6.2		35	15	15	
Total operating funds for Task Group 2.6		45	75	75	

3.9.4 Facilities

The Reductive Extraction Process Facility (Task 2.4.3) and the Metal Transfer Process Facility (Task 2.5.3) will be used to test methods for bismuth removal. The Fluorination-Reconstitution Engineering Facility (Tasks 2.2.7 and 2.3.3) will be used to test methods for uranium valence adjustment.

3.9.5 Task 2.6.1 Uranium valence adjustment

The object of this task is to develop the technology for continuously controlling the $[U^{4+}]/[U^{3+}]$ ratio in the fuel salt stream returning to the reactor. A method by which the $[U^{4+}]/[U^{3+}]$ ratio can be adjusted, such as electrolytic reduction of $[U^{4+}]$, will be developed. Equipment will be installed in the Fluorination-Reconstitution Engineering Facility to study continuous closed-loop control of uranium valence in the salt from the reconstitution step of this facility.

3.9.6 Task 2.6.2 Bismuth removal

The object of this task is to develop the technology for removing both entrained and dissolved bismuth from fuel salt before it enters the reactor from the processing plant. Experiments for demonstrating continuous bismuth removal will be carried out in the Metal Transfer Process Facility, and the Reductive Extraction Process Facility. Sampling techniques will be developed for use with low bismuth concentrations in fluoride salts. Tests to study the effectiveness of nickel wool beds for removing entrained bismuth will be performed. Chemical studies to identify the dissolved bismuth species will be carried out and methods for removing these species will be developed.

3.10 TASK GROUP 2.7 ACTINIDE-FISSION PRODUCT SEPARATION AND ACTINIDE RECYCLE

3.10.1 Objective

The objective of this task group is to develop a flowsheet for fuel processing which will allow the transuranium actinides to be separated from the fission products and returned to the reactor for transmutation to less undesirable isotopes.

3.10.2 Schedule

The schedule for this task group is shown in Table 3.10.2.

Table 3.10.2. Schedule for Task Group 2.7 - Actinide-fission product separation and actinide recycle

	Fiscal year	
	1975	1976
2.7.1 Chemistry studies		
2.7.1.1 Chemistry of zirconium chlorides	—	
2.7.2 Flowsheet development		
2.7.2.1 Heat balances	—	
2.7.2.2 Mass balances	—	
2.7.2.3 Parametric studies	—	
2.7.2.4 Waste characterization	—	
2.7.3 Identification of required development	—	

Table 3.10.3. Operating budget for Task Group 2.7 - Actinide-fission product separation and actinide recycle (costs in 1000 dollars)

	Fiscal year	
	1975	1976
2.7.1 Chemistry studies		
2.7.1.1 Chemistry of zirconium chlorides	20	
Subtotal 2.7.1	20	
2.7.2 Flowsheet development		
2.7.2.1 Heat balances	5	
2.7.2.2 Mass balances	5	
2.7.2.3 Parametric studies	10	
2.7.2.4 Waste characterization	5	
Subtotal 2.7.2	25	
2.7.3 Identification of required development	5	
Total operating funds for Task Group 2.7	50	

3.10.3 Funding

The operating budget for this task group is shown in Table 3.10.3. No capital equipment funds will be required.

3.10.4 Facilities

This work will require only the use of ORNL computing facilities and general chemical laboratory facilities.

3.10.5 Task 2.7.1 Chemistry of zirconium chlorides

The primary objective of this task is to determine the oxidation state of zirconium chloride dissolved in molten LiCl when the chloride melt is in equilibrium with Li-Bi alloys or in equilibrium with HCl-H₂ mixtures. Initially, the oxidation state will be determined as a function of the lithium concentration in the alloy. A special effort will be to determine conditions under which gaseous zirconium chloride is present at significant partial pressures above the LiCl solution. Some effort will be devoted to determining activity coefficients for ZrCl₄ (or ZrCl₃) in molten LiCl solution. Work in this task group is required for determining the behavior of zirconium in actinide-recycle flowsheets under consideration.

3.10.6 Task 2.7.2 Flowsheet analysis

3.10.6.1 Subtask 2.7.2.1 Heat balances

An existing general computer code will be used to calculate the amount of decay heat release for each operation in the processing plant. This is necessary to determine the heat transfer area required in each piece of equipment. In some cases, the allowable heat release rate will limit the fission product concentrations because of heat removal considerations. Decay heat generation rates will be obtained from concentration data determined in mass balance calculations.

3.10.6.2 Subtask 2.7.2.2 Mass balances

For the proposed flowsheet mass balance calculations will be made for each fission product nuclide and for all transuranium isotopes. The computer codes mentioned in the previous section will also be used here. The mass balance calculations will be coupled with a calculation for the reference reactor design in order that the effect of calculated removal times and the effect of recycle of transuranium isotopes on the reactor performance can be determined. All calculations will be continually updated as new process data (equilibria, mass transfer, etc.) become available.

3.10.6.3 Subtask 2.7.2.3 Parametric studies

The computer code which calculates mass balances, heat generation rates, and waste production rates will be used to do parametric studies in order that modifications of the flowsheet will reflect an optimization of the effect caused by each characteristic which is studied. Parameters to be varied include reductant concentrations, circulation rates, and modifications of the flowsheet.

3.10.6.4 Subtask 2.7.2.4 Waste characterization

The material balance calculations using the previously mentioned computer codes will be used to describe volumes and compositions of waste streams associated with each proposed flowsheet. Waste disposal problems associated with each flowsheet will be assessed from these calculations.

For each waste stream, calculations using the computer code ORIGEN will be made to determine the activity and waste hazard as a function of time and to compare waste hazards of MSBR's with waste hazards of other reactors.

3.10.7 Task 2.7.3 Identification of required development

Analysis of flowsheets generated in this task will allow identification of areas in which development work must be carried out in order to assess the desirability and feasibility of the resultant flowsheets. A report summarizing the results of this analysis and indicating the required development work will be issued.

3.11 TASK GROUP 2.8 MSBR PROCESSING ENGINEERING LABORATORY DESIGN AND CONSTRUCTION

3.11.1 Objective

The objective of this task group is to provide space for engineering and chemical development activities associated with the development of the technology for processing the fuel from molten-salt breeder reactors.

The available work space for chemical and engineering development of MSBR fuel reprocessing consists of one small alpha laboratory in Bldg. 3019; two standard chemical laboratories in Bldg. 4500; Bldg. 3592, which has two equipment areas, each about 15 x 15 x 8 ft high; Bldg. 3541, equipped with three standard laboratory hoods and two walk-in hoods; and Bldg. 4505, where two 6 x 8 x 26-ft-high cell spaces have been converted to permit experiments with beryllium salts; and a portion of the high-bay area in Bldg. 7503 (MSRE building). These work areas have been obtained by modifying existing facilities. The facilities permit work with alpha materials in Bldg. 3019 and beryllium only in

all other areas. Change room entrances and other provisions are marginal for all areas except Bldg. 3541 and Bldg. 7503. The existing facilities are adequate only for limited alpha laboratory work, small bench-scale engineering tests of individual system components, and tests of 1/2-scale individual process equipment units. None of the engineering facilities will permit proof-testing with alpha-active materials or demonstration of a complete processing plant system, even on a very small scale. Full-scale testing of the complete processing system with molten salt and bismuth, alpha materials, and perhaps low-level beta-gamma radioactive tracers will be required to demonstrate process performance. The existing facilities are crowded, are inefficient because of the assignment of personnel to widely separated facilities, and are completely inadequate for the planned development program. No other facilities exist at the Laboratory that could meet the specific and unique requirements for engineering development of MSBR processing.

Engineering-scale experiments planned for the facility will range in complexity from simple test loops for pump and valve development for molten salt or bismuth systems to a full-scale integrated processing equipment installation for operation with low-level beta-gamma tracers and alpha materials.

3.11.2 Schedule

The schedule for Task Group 2.8, MSBR Processing Engineering Laboratory Design and Construction, is given in Table 3.11.2.

3.11.3 Funding

The operating budget for Task Group 2.8 is shown in Table 3.11.3. This task will require GPP funds of about \$12,000,000, to be authorized in FY 1977.

3.11.4 Task 2.8.1 Conceptual design

This project will consist of a new building which will be capable of containing laboratory and large-scale engineering experiments with beryllium and thorium compounds and alpha-emitting materials. The building will be a three-story concrete and masonry building with a metal high-bay area. Overall dimensions will be 125 ft by 152 ft by 45 ft high. The high-bay area will be 45 ft high. An 18 ft by 32 ft by 15 ft truck air lock will be provided in the high-bay area. The building, plus air lock, will have a gross floor area of 33,000 ft² and a gross volume of about 800,000 ft³. Portions of the building will be sealed and operated at a negative pressure of 0.3 in. H₂O to provide suitable containment of hazardous materials.

Task 2.8.1 consists of establishing (1) the criteria for the building; (2) preparing a safety analysis and an environmental statement; (3) developing preliminary site preparation plans, floor plans, architectural

Table 3.11.2. Schedule for Task Group 2.8 - MSBR Processing Engineering
Laboratory design and construction

	Fiscal year						
	1975	1976	1977	1978	1979	1980	1981
2.8.1 Conceptual design	-----						
2.8.2 Title I design			-----				
2.8.3 Title II design				-----			
2.8.4 Construction				-----			
2.8.5 Acceptance of facility (system tests)						-----	

Table 3.11.3. Operating budget for Task Group 2.8 — MSBR Processing
 Engineering Laboratory design and construction
 (costs in 1000 dollars)

	Fiscal year						
	1975	1976	1977	1978	1979	1980	1981
2.8.1 Conceptual design	80	50					
2.8.2 Title I design			187				
2.8.3 Title II design			63	225			
2.8.4 Construction				70	150	150	
2.8.5 Acceptance of facility							40
Total operating costs for Task Group 2.8	80	50	250	295	150	190	

and structural plans, utility plans, and waste disposal plans; (4) preparing a cost estimate for the project; and (5) preparing and submitting a long form construction project data sheet for FY 1977 project authorization.

3.11.5 Task 2.8.2 Title I design

Title I design for the building will begin after project authorization in FY 1977. This work represents the first definitive design work and must be completed before construction starts in order to verify the conceptual design, the scope of the project, and the estimate of project cost. Operating fund requirements during Title I design cover 5 to 6 personnel, including the program and project engineers; design work not covered by capital funds; advance procurement, estimating, and liason between the program and project activities.

3.11.6 Task 2.8.3 Title II design

Title II design will start immediately after the Title I design has been completed. This effort defines the construction activities to be undertaken and some construction, such as site preparation, will begin before completion of Title II design. Operating funds are required during Title II design for purposes similar to those discussed above for Title I design.

3.11.7 Task 2.8.4 Construction

Construction will begin in mid FY 1978 and continue through FY 1980. This period includes the time required for acceptance tests. Operating funds are required for support of the project and program engineers.

3.11.8 Task 2.8.5 Acceptance of facility

All equipment in the facility must be tested before the facility will be accepted. These systems tests will take place during the last three months of construction.

3.12 TASK GROUP 2.9 INTEGRATED PROCESS TEST FACILITY

3.12.1 Objective

The objective of this task group is to provide a facility for the demonstration of processes and equipment for fuel processing at the pilot plant level in a nonradioactive system. This facility is needed (1) to demonstrate the safety and performance reliability of processing systems, (2) to provide information for development of maintenance methods, and

(3) to provide a basis for evaluation of continuous, on-site processing of MSBR fuel salt. Information will be obtained that is necessary for the development of overall plant design for molten-salt reactor processing systems. No viable alternative MSBR fuel processing development facilities exist, and this facility cannot be deferred if the fuel processing data and plant design information are to be available on a schedule allowing the timely development of molten-salt breeder reactors.

3.12.2 Schedule

The schedule for this task group is shown in Table 3.12.2.

3.12.3 Funding

The operating budget for this task group is shown in Table 3.12.3.1. Authorization of capital funds in the amount of \$7,000,000 will be required during FY 1978. Capital equipment fund requirements are shown in Table 3.12.3.2.

3.12.4 Facilities

The Integrated Process Test Facility will consist of the equipment necessary for the simultaneous operation of all parts of a processing system for study and demonstration of continuous processing of molten-salt breeder reactor fuel salt on a scale that is 25% to 75% of that required for a 1000-MW(e) MSBR. Operation of the system will be carried out using tracer-level activity suitable for determining the behavior of key actinide and fission product elements. The operations to be tested include fluorination of fuel salt for removal of uranium, reductive extraction for removal of protactinium, rare-earth removal by the metal transfer process, and reconstitution of MSBR fuel salt from UF_6 recovered in the fluorination operation and the processed fuel carrier salt. The total estimated cost for the Integrated Process Test Facility is \$7 million and authorization is required during 1978.

3.12.5 Task 2.9.1 Definition of experimental program and preliminary design

The experimental program will be defined and the facility will be designed accordingly. Preliminary design of this facility will consist of a choice of the scale of the equipment, identification of auxiliary equipment (gas supplies, excess reagent and waste disposal systems, instrumentation calibration stations, etc.), location of equipment, and preliminary sketching and layout of equipment. The areas where further development will be required for completion of final design will be identified. Experimental programs to carry out this development will be planned.

Table 3.12.2. Schedule for Task Group 2.9 - Integrated Process Test Facility

	Fiscal year											
	1975	1976	1977	1978	1979	1980	1981	1982	1983	1984	1985	1986
2.9.1 Preliminary design and experimental program		—										
2.9.2 Development for final design		—	—									
2.9.3 Conceptual design		—										
2.9.4 Title I design				—								
2.9.5 Title II design					—							
2.9.6 Equipment fabrication					—	—						
2.9.7 Equipment installation							—	—				
2.9.8 Initial testing and operator training								—	—			
2.9.9 Operation									—	—	—	—

Table 3.12.3.1. Operating budget for Task Group 2.9 — Ingegrated Process Test Facility
(costs in 1000 dollars)

	Fiscal year												
	1975	1976	1977	1978	1979	1980	1981	1982	1983	1984	1985	1986	
2.9.1 Preliminary design and experimental program		25											
2.9.2 Development for final design		60	170	15									
2.9.3 Conceptual design		80	20										
2.9.4 Title I design				150									
2.9.5 Title II design				75	150								
2.9.6 Equipment fabrication					200	200							
2.9.7 Equipment installation						75	300						
2.9.8 Initial testing and operator training							291	291					
2.9.9 Operation								2167	2824	2824	2700		
Total operating costs for Task Group 2.9		165	190	240	350	275	591	2458	2824	2824	2700		

Table 3.12.3.2. Capital equipment fund requirements for Task Group 2.9 - Integrated Process Test Facility (costs in 1000 dollars)

	Fiscal year						
	1980	1981	1982	1983	1984	1985	1986
2.9.7 Computer for data processing and process control	400						
2.9.9 Miscellaneous equipment and instrumentation			200	300	400	300	
Total capital equipment funds for Task Group 3.12	400		200	300	400	300	

3.12.6 Task 2.9.2 Development work required for design

Development work which will be required includes (1) development of special instrumentation, and (2) development of filtration techniques for particulate removal. Other areas requiring development will be defined during preliminary design.

3.12.7 Task 2.9.3 Conceptual design

This task consists of (1) establishing criteria for the processing plant, (2) preparing a safety analysis and an environmental statement, (3) developing a preliminary layout and design for the processing system, including instrumentation and controls, (4) preparing a cost estimate for the project, and (5) preparing and submitting a long form construction project data sheet for FY 1978 authorization.

3.12.8 Task 2.9.4 Title I design

Title I design for the facility will begin after authorization in FY 1978. This work represents the first definitive design work and must be completed before construction starts in order to verify the conceptual design, the scope of the project, and the estimate of project cost. Operating fund requirements during Title I design cover 5 to 6 personnel including the program and project engineers, design work not covered by capital funds, advance procurement, estimating and liason between the program and project activities.

3.12.9 Task 2.9.5 Title II design

Title II design will start immediately after the Title I design has been completed. This effort defines fabrication and construction activities to be undertaken and some equipment fabrication can begin before completion of Title II design. Operating funds are required during Title I design for purposes similar to those discussed above for Title I design.

3.12.10 Task 2.9.6 Equipment fabrication

Some equipment fabrication will begin soon after Title II design begins. Operating funds are required to support four personnel for project engineering and liason between design and fabrication activities.

3.12.11 Task 2.9.7 Equipment installation

Equipment installation will begin as individual equipment items become available. Operating funds supporting six personnel will be required for liason between fabrication and installation activities.

3.12.12 Task 2.9.8 Initial testing and operator training

Acceptance tests will include leak checks and testing of all pumps, motors, and electrical equipment. Salt and bismuth will be charged to the system and will be circulated at flow rates up to the design limits. This period will also be used for training operating personnel.

3.12.13 Task 2.9.9 Operation

Following initial testing the portions of the process requiring HF, F₂, HCl, and Li will be charged with these materials. The necessary uranium, rare-earth, and zirconium compounds will be added and operation of the plant will start. Operation will continue for about 3.5 years.

REFERENCES FOR SECTION 3

1. M. R. Bennett and L. M. Ferris, *J. Inorg. Nucl. Chem.* 36: 1285 (1974).
2. L. M. Ferris, J. C. Mailen, J. J. Lawrance, F. J. Smith, and E. D. Noguera, *J. Inorg. Nucl. Chem.* 32: 2010-2035 (1970).
3. M. E. Whatley, L. E. McNeese, W. L. Carter, L. M. Ferris, and E. L. Nicholson, *Nucl. Appl. Tech.* 8: 170-178 (1970).
4. L. E. McNeese, *Engineering Development Studies for Molten-Salt Breeder Reactor Processing No. 2*, ORNL-TM-3137 (February 1971).
5. *MSR Program Semiannu. Progr. Rep. Feb. 28, 1970*, ORNL-4548.
6. L. M. Ferris, F. J. Smith, J. C. Mailen, and M. J. Bell, *J. Inorg. Nucl. Chem.* 34: 313-20 (1972).
7. L. E. McNeese, *Engineering Development Studies for Molten-Salt Breeder Reactor Processing No. 8*, ORNL-TM-3258 (May 1972).
8. L. E. McNeese, *Engineering Development Studies for Molten-Salt Breeder Reactor Processing No. 6*, ORNL-TM-3141 (December 1971).
9. W. L. Carter and E. L. Nicholson, *Design and Cost Study of a Fluorination--Reductive Extraction--Metal Transfer Process Plant for the MSBR*, ORNL-TM-3579 (May 1972).
10. *MSR Program Semiannu. Progr. Rep. Aug. 31, 1970*, ORNL-4622.
11. *Chemical Technology Div. Annu. Prog. Rep. May 31, 1967*, ORNL-4145, pp. 95-97.
12. J. S. Watson and L. E. McNeese, *Engineering Development Studies for Molten-Salt Breeder Reactor Processing No. 9*, ORNL-TM-3259, p. 52.
13. L. E. McNeese, *Engineering Development Studies for Molten-Salt Breeder Reactor Processing No. 10*, ORNL-TM-3352 (in preparation).
14. *MSR Program Semiannu. Progr. Rep. Feb. 29, 1972*, ORNL-4782.
15. L. E. McNeese, *Engineering Development Studies for Molten-Salt Breeder Reactor Processing No. 5*, ORNL-TM-3140 (October 1971).
16. L. E. McNeese, *Engineering Development Studies for Molten-Salt Breeder Reactor Processing No. 7*, ORNL-TM-3141 (February 1972).

17. J. S. Watson and L. E. McNeese, "Axial Dispersion in Packed Columns During Countercurrent Flow, Liquids of High Density Difference," *Ind. Eng. Chem. Process Des. Develop.* 11: 120-21 (1972).
18. J. S. Watson and H. D. Cochran, "A Simple Method for Estimating the Effect of Axial Backmixing on Countercurrent Column Performance," *Ind. Eng. Chem. Process Des. Develop.* 10: 83-85 (1971).
19. *MSR Program Semiannu. Progr. Rep. Feb. 28, 1971*, ORNL-4676.
20. *MSR Program Semiannu. Progr. Rep. Aug. 31, 1971*, ORNL-4728.
21. *Chemical Technology Div. Annu. Progr. Rep. March 31, 1973*, ORNL-4883, p. 25.
22. W. H. Carr, "Volatility Processing of the ARE Fuel," *Chem. Engr. Progr. Symp. Series.* 56 (1960), p. 57.
23. *Chemical Technology Div. Annu. Progr. Rep. May 31, 1964*, ORNL-3627, pp. 29-35.
24. W. H. Carr, et al., *Molten Salt Volatility Pilot Plant: Recovery of Enriched Uranium from Aluminum-Clad Fuel Elements*, ORNL-4574, April 1971.
25. R. B. Lindauer, *Processing of the MSRE Flush and Fuel Salts*, ORNL-TM-2578 (August 1969).

4. FUEL-PROCESSING MATERIALS DEVELOPMENT

4.1 INTRODUCTION

The materials requirements for MSBR fuel processing systems depend upon the particular process operation considered and the design of the specific equipment for effecting this operation. The most important operations consist in (1) removing fission products, (2) isolating ^{233}Pa during its decay to ^{233}U , and (3) removing excess uranium for sale. Processes involving uranium removal by fluorination and selective chemical reduction of protactinium and fission products from the fuel salt into liquid bismuth appear to be the most promising process methods currently available.

4.1.1 Objective

The objectives of the fuel-processing materials development program are to identify materials capable of satisfactorily containing the fluids present in an MSBR fuel processing system, and to develop the materials technology necessary for constructing a processing system. It should be clearly recognized that a satisfactory resolution of materials problems will probably involve the use of several materials as discussed below.

4.1.2 Scope

The scope of this program consists in identifying materials which are compatible with the fluids present in a fuel processing system, and conducting fabrication and joining studies to provide information required for construction of processing systems.

4.1.2.1 Task Group 3.1 Identification of corrosion resistant materials

Compatibility tests will be conducted with MSBR fuel salt, Bi-Li-Th solutions, and LiCl under conditions which simulate fuel processing systems in order to identify satisfactory containment materials for the various process steps.

4.1.2.2 Task Group 3.2 Development of fabrication and joining techniques

Based on information obtained in Task Group 3.1, materials will be selected for fabrication of MSBR fuel processing experiments and systems. Fabrication and joining studies will be conducted as required in order to (1) develop fabrication procedures, (2) determine optimum fabrication variables, and (3) develop a basis for improving present procedures.

4.1.2.3 Task Group 3.3 Construction of fuel processing experiments and systems

Once the general details for a fuel processing experiment or system have been fixed, materials and fabrication procedures for construction of the associated equipment will be selected and qualified. In some cases, prototypic construction of components using data obtained in Task Group 3.2 will be required.

4.2 PROGRAM BUDGET AND SCHEDULE

4.2.1 Schedule and key program milestones

The schedule for work on fuel processing materials development is shown in Table 4.2.1.1. The key program milestones associated with the development of fuel processing materials are listed in Table 4.2.1.2 and occur at the times indicated in Table 4.2.1.1.

4.2.2 Funding

Operating fund requirements for work on fuel processing materials development are shown in Table 4.2.2.1, and capital equipment fund requirements are shown in Table 4.2.2.2.

4.3 MATERIAL REQUIREMENTS, BACKGROUND, AND STATUS OF DEVELOPMENT

4.3.1 Materials requirements

In the reference fuel processing flowsheet a number of environments are present:

1. Molten salt and gaseous mixtures of F_2 and UF_6 at 500 to 550°C.
2. Molten salt and bismuth containing lithium and thorium at 550 to 650°C.
3. Bismuth containing 5 to 50 at. % Li and LiCl at 550 to 650°C.
4. $HF-H_2$ mixtures and molten fluorides at 550 to 650°C.

One of the principal requirements of a material (or materials) to be used in constructing fuel processing components is compatibility with the environment which the component will encounter. It is not necessary that a single material be compatible with all of the environments since the system can be designed to allow for segregation of a given environment to a particular portion of the system. It is expected that at least two classes of materials will be necessary: one that can be used in the fluorination and fuel reconstitution steps and another for the reductive-extraction

portions of the system. A fundamental requirement of the materials selected is fabricability, for ultimately the materials must be used in the construction of commercial processing plants. Availability and cost are also important factors that must be considered.

4.3.2 Background

Nickel or a nickel-base alloy, which in some cases must be protected from corrosion by a layer of frozen salt, can be used for construction of fluorinators for removal of uranium from molten fluoride mixtures, and for those portions of a plant that will contain F_2 , UF_6 , and HF. The chemical corrosion of nickel and nickel-base alloys during fluorination operations has been evaluated previously at ORNL. Much of this information has evolved from fuel recovery operations conducted with irradiated metallic reactor fuel elements using molten fluoride mixtures in which UF_4 was converted to UF_6 by contact with fluorine. During these studies, a number of materials were exposed to gaseous fluorine and molten salt. Most of the data were obtained during operation¹ of two plant-scale fluorinators constructed of L-nickel at temperatures ranging from 520 to 730°C which contained a number of corrosion specimens (20 different materials). Several specimens had lower rates of maximum corrosive attack than L-nickel, and the specimen showing the least attack, Hymu 80, had a maximum bulk loss rate of 11 mils/month based on total time in molten salt. Other corrosion coupon tests at 600°C showed that INOR-1 is also more resistant to corrosion than L-nickel.² Although these materials exhibit better corrosion resistance than L-nickel, this material should have acceptable corrosion behavior if protected by a frozen-salt layer and is preferred for use in MSBR processing plants since corrosion of the other materials introduces volatile fluorides of chromium and molybdenum into the fluorinator offgas.

The previous fuel recovery operations afford useful guidelines and background information for the selection of materials for the proposed process applications. They also show the importance, however, of inerting the metal surfaces in a fluorinator with a passive frozen-salt layer. In addition to compatibility evaluations, many years of experience have been accumulated in the fabrication and joining of this class of alloys, stemming from the construction of reactors and associated hardware³ as well as fluoride-salt purification equipment.

For those portions of the process system that will be in contact with bismuth or bismuth solutions, conventional materials of construction such as Fe-, Co-, or Ni-base alloys are not acceptable because of either (1) excessively high solubility in bismuth or (2) a tendency to undergo mass transfer when exposed to bismuth in a system having a temperature gradient. Materials which have shown good compatibility with bismuth include graphite and refractory metals such as tungsten, rhenium, molybdenum and tantalum.³⁻⁶ Except for tantalum, all of these materials are difficult to fabricate and join. All oxidize rapidly in air at process temperatures and require some type of atmospheric protection.

Table 4.2.1.1. Schedule for work on fuel processing materials development

	Fiscal year							
	1975	1976	1977	1978	1979	1980	1981	1982
3.1 Determination of corrosion resistant materials			▽ ^a ▽ ^b				▽ ^c	
3.2 Development of fabrication and joining techniques				▽ ^d	▽ ^e	▽ ^f ▽ ^g		
3.3 Construction of engineering fuel processing experiments				▽ ^h	▽ ⁱ			

Table 4.2.1.2. Key milestones for MSBR fuel processing materials development

Milestone	Description
a	Complete compatibility studies relating to selection of type of graphite for use in Integrated Process Test Facility. Complete thermal convection loop tests of molybdenum in molten salts. Initiate forced circulation loop tests with graphite in Bi-Li-Th.
b	Initiate forced circulation loop tests with molybdenum in Bi-Li-Th (if required). Initiate forced circulation loop tests with tantalum in molten salts (if required).
c	Complete forced circulation loop studies.
d	Complete fabrication development studies with graphite.
e	Complete fabrication studies on molybdenum.
f	Complete joining studies on molybdenum.
g	Complete joining studies on graphite.
h	Complete surveillance program on samples from Reductive Extraction Process Facility.
i	Complete surveillance program on samples from Metal Transfer Process Facility.

Table 4.2.2.1. Operating fund requirements for fuel processing materials development
(costs in 1000 dollars)

	Fiscal year												
	1975	1976	1977	1978	1979	1980	1981	1982	1983	1984	1985	1986	
3.1 Determination of corrosion resistant materials	118	185	200	220	264	200							
3.2 Development of fabrication and joining techniques		95	143	166	165	100							
3.3 Construction of engineering fuel processing experiments	5	20	50	75	60	75	75	75	30	30	30		
Total fuel processing materials development operating funds	123	300	393	461	489	375	75	75	30	30	30		

Table 4.2.2.2. Summary of capital equipment funds required for fuel processing materials development
(costs in 1000 dollars)

	Fiscal year											
	1975	1976	1977	1978	1979	1980	1981	1982	1983	1984	1985	
3.1 Determination of corrosion resistant materials		85	450									
3.2 Determination of fabrication and joining techniques			170	125	20							
3.3 Construction of engineering fuel processing experiments					25	25	25	25	25	25	25	
Total capital equipment funds for processing materials development		85	620	125	45	25	25	25	25	25	25	

4.3.3 Status of development

For the past several years, materials have been investigated that can be used to contain Bi-Li-Th solutions at temperatures ranging from 550 to 700°C. These studies have been concentrated on molybdenum and molybdenum alloys, tantalum and tantalum alloys, and graphite. It currently appears that the use of graphite for vessels and molybdenum or molybdenum alloys for interconnecting lines, agitators, and other components represents the optimum combination of available materials.

4.3.3.1 Molybdenum

The selection of molybdenum as a potential processing plant material was based on corrosion investigations at ORNL³ and elsewhere^{4,5} which showed it to resist dissolution and chemical attack in molten bismuth. The studies at ORNL were conducted in both static capsules and small thermal convection loops which provided a temperature gradient of 100 to 200°C in the bismuth circuit. Tests were conducted on low-carbon molybdenum and the alloy TZM in pure bismuth and bismuth containing up to 3 wt % (50 at. %) Li. Mass transfer of these materials was negligible in the temperature range 500 to 700°C for periods as long as 10,000 hr. Tests carried out in static bismuth also have shown no effect of stress on the corrosion rate for molybdenum.

Although molybdenum has excellent resistance to corrosion, there are difficulties associated with its use. Molybdenum is a particularly structure-sensitive material; that is, its mechanical properties are known to vary widely, depending upon how it has been metallurgically processed. The ductile-brittle transition temperature for molybdenum varies from below room temperature to 200-300°C, depending both upon strain rate and the microstructure of the metal. Maximum ductility is provided in the cold-worked, fine-grained condition. Recent advances in vacuum-melting practices have led to the production of material with improved and more reproducible metallurgical properties. The arc-melted, low-carbon, low-oxygen grade of molybdenum, available commercially, affords relatively good control of grain size and interstitial impurity level. Nevertheless, the use of molybdenum as a structural material requires highly specialized assembly procedures and imposes stringent limitations on system design from the standpoint of geometry and rigidity.

Several advances in the fabrication technology of molybdenum were made at ORNL during construction of a molybdenum system in which bismuth and molten salt could be countercurrently contacted in a 1-in.-ID, 5-ft-high packed column having 3.5-in.-ID upper and lower disengaging sections.⁷ Techniques were developed for the production of closed-end molybdenum vessels by back extrusion, which involves the flow of metal into a die and the backward flow of metal over an advancing plunger. This fabrication process has the advantage that the diameter of the part produced

is as large as or larger than that of the starting metal blank; the configuration of the part can be changed by relatively simple changes in the die and mandrel design; and sufficient deformation can be accomplished that a wrought or fine-grained structure having good mechanical properties is produced. Parts that were free from cracks and had high-quality surfaces were produced consistently with this technique by the use of ZrO_2 -coated plungers and dies and extrusion temperatures of 1600 to 1700°C. Eleven closed-end forgings were produced that had a 3-7/8-in. outside diameter, a 3.5-in. inside diameter, and lengths from 8 to 12 in. The 5.5-ft-long molybdenum pipe for the extraction column, having an outside diameter of 1.16 in. and an inside diameter of 1 in., was produced by floating mandrel extrusion at 1600°C. Three extrusions for producing this material were performed; the second extrusion produced a pipe 11.5 ft in length that was concentric to within 0.007 in. with excellent external and internal surfaces.

In evaluating three sizes of commercially available molybdenum tubing (1/4-, 3/8-, and 1/2-in. OD), it was found that the 1/2-in. tubing was ductile at room temperature, while the 3/8-in. tubing was ductile only at temperatures above 150 to 250°C and the 1/4-in. tubing was ductile only at temperatures above 300°C. It was found, however, that the 3/8-in. and 1/4-in. tubing could be made ductile at room temperature by the removal of 0.001 to 0.003 in. of material from the inside of the tubing by etching. Further investigation showed that tubing which is ductile at room temperature should be produced routinely by careful control of surface contamination during tubing fabrication.

It was also demonstrated that complex components can be fabricated from molybdenum by welding, using either the gas tungsten-arc or electron-beam processes.⁷ Welding procedures were developed to deal with the inherent tendencies of molybdenum toward hot cracking due to contamination (such as from O_2 or N_2) as well as abnormal grain growth, which results in welds that are brittle at room temperature. Mechanical tube-to-header joints were also produced by pressure bonding, using commercial tube expanders. Tubes which were rolled into headers at 250°C remained leak-tight after repeated thermal cycling to 500°C. Welding studies have centered on three major types of joint: tube-to-tube sheet, tube-to-tube, and 3.5-in.-diam circumferential girth welds. Electron-beam and gas tungsten-arc welding techniques both have been investigated. In addition, a commercial orbiting-arc welding head was modified to produce helium leak-tight (5×10^{-8} atm cm^3 /sec) tube-to-tube field welds. Two of the most important factors found to minimize molybdenum weldment cracking have been stress relieving of components and preheating prior to welding.

Although helium leak-tight molybdenum welds have been produced consistently using both the electron-beam and tungsten-arc techniques, the ductile-brittle transition of the resulting welds were above room temperature, and it was necessary to design each joint to mechanically support the welds. The joints were also back-brazed or vapor plated with tungsten to provide a secondary barrier against leakage.

Studies have been carried out for the development of braze materials for joining molybdenum that are resistant to corrosion by bismuth and molten salts.³ An iron-base alloy of the composition Fe-Mo-Ge-C-B (75-15-5-4-1 wt %) has been found to have good wetting and flow properties, a moderately low brazing temperature (<1200°C), and adequate resistance to corrosion by bismuth at 650°C.

The results of work to date on molybdenum fabrication techniques have been quite encouraging, and it is believed that the material can be used in constructing components for processing systems if proper attention is given to its fabrication characteristics.

4.3.3.2 Tantalum

Corrosion tests in molten bismuth and Bi-Li solutions have been conducted with pure tantalum and the tantalum alloy T-111 (8% W, 2% Hf, bal Ta). In quartz thermal-convection loops at 700°C, the mass transfer rate of pure tantalum in these liquid metals was greater than that of molybdenum, although the rate was still less than 3 mils/year. Mass transfer rates for the alloy T-111 were comparable to those for molybdenum, but the mechanical properties of T-111 were strongly affected by interaction of the alloy with interstitial impurities, primarily oxygen, in quartz--pure-bismuth loop experiments. A more recent test carried out at 700°C with a Bi-2.5 wt % Li mixture in a loop constructed of T-111 tubing did not measurably affect the mechanical properties of the T-111, and the mass transfer rate was again insignificant.

The resistance of tantalum or T-111 to corrosion by fuel salt is unknown at this time, but it appears marginal from thermodynamic considerations. However, tantalum should withstand attack by molten LiCl, and experiments are planned to investigate this.

Several complex assemblies have been fabricated at ORNL using the T-111 alloy, the largest of which was a forced convection loop which circulated liquid lithium for 3000 hr at 1370°C.⁸ In contrast to molybdenum, this alloy is quite ductile in the as-welded condition; thus it appears promising for complex geometries that would operate principally in Bi or Bi-Li solutions. The tantalum alloy, however, would require a higher degree of protection from interstitial impurities (O, C, N) than would molybdenum.

4.3.3.3 Graphite

Graphite, which has excellent compatibility with fuel salt, also shows promise for the containment of bismuth. Compatibility tests to date have shown no evidence of chemical interaction between graphite and bismuth containing up to 3 wt % (50 at. %) Li. However, the largest open pores of most commercially available polycrystalline graphites are penetrated to some extent by liquid bismuth. Static capsule tests⁶ of three commercial graphites (ATJ, AXF-5QBG, and Graphitite A) were

conducted for 500 hr at 700°C using both high-purity bismuth and Bi-3 wt % (50 at. %) Li. Although penetration by pure bismuth was negligible, the addition of lithium to the bismuth appeared to increase the depth of permeation and, presumably altered the wetting characteristics of the bismuth.

Although it is not known whether limited penetration of graphite by bismuth solutions is tolerable, there are several approaches that have potential for decreasing the extent to which a porous graphite is penetrated by bismuth and bismuth-lithium alloys. Two well-established approaches are multiple impregnations with liquid hydrocarbons which are then carbonized and/or graphitized and (2) pyrocarbon coatings. Other approaches are based on vapor-deposited molybdenum coatings, and the use of carbide-forming sealants. Each of these sealing approaches is being evaluated. The wetting characteristics of graphite are also being studied as a function of surface pretreatments such as dedusting, alcohol wash and oven dry, and vacuum degassing at 700 to 1000°C.

Fabrication of a processing plant from graphite would necessitate graphite-to-graphite and graphite-to-metal joints. Development studies^{9,10} have been conducted on both types of joints using high-temperature brazes and also metals which bond by carbide formation. Several of these experimental joining techniques show promise for the chemical processing application. Other workers^{11,12} have pioneered mechanical joints which may be satisfactory for the proposed application.

4.3.4 Basis for materials selection

It is expected that a combination of the above materials would be used in the construction of a fuel processing system. Although tantalum alloys present few engineering developmental problems, it is expected that compatibility with molten fluorides and susceptibility to environmental contamination may limit their use. From an engineering view, the use of graphite would require less development work than molybdenum and, therefore, major emphasis will be placed on studies with graphite for the near term. The work outlined for the longer term, however, allows for more complete development of these materials for more extensive processing applications. Near-term compatibility results and fuel processing flow-sheet developments will dictate the extent to which subsequent work will be undertaken for each of the materials.

4.4 TASK GROUP 3.1 DETERMINATION OF CORROSION-RESISTANT MATERIALS

4.4.1 Objective

The purpose of this task group is to determine the compatibility of potential container materials with fuel processing system environments under simulated fuel processing conditions. Materials being investigated include molybdenum, tantalum alloys, and graphite.

4.4.2 Schedule

The schedule for work in this task group is shown in Table 4.4.2.

4.4.3 Funding

Operating fund requirements for this task group are shown in Table 4.4.3.1, and capital equipment requirements are shown in Table 4.4.3.2.

4.4.4 Facilities

This task group will require use of the following facilities:

Bldg. 4500 S, Rm. T-26 — All static and thermal-convection loop tests will be run in this area.

Bldg. 9201-3 — Forced-circulation loops will be conducted on the operating floor of this building.

4.4.5 Task 3.1.1 Compatibility of molybdenum with molten salts and Bi-Li-Th solutions

4.4.5.1 Subtask 3.1.1.1 Thermal-convection loop test in molten salt

The corrosion of molybdenum in molten salt can probably be described by the reaction:

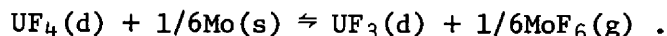

When compared with fluorides of other elements present in the system, MoF_6 is relatively unstable, and it seems unlikely that any serious attack of molybdenum by the fuel carrier salt will occur. To verify this hypothesis, a thermal convection loop test will be constructed of molybdenum and operated with fuel carrier salt at a maximum temperature of 700°C and a temperature difference of approximately 100°C . Test coupons and tensile samples will be included in both hot and cold sections. In addition to mechanical properties changes, evaluation of loop components will be obtained from weight-change measurements, chemical analyses, and metallographic examination.

Table 4.4.2. Scheule for work in Task Group 3.1 — Determination of corrosion-resistant materials

	Fiscal year						
	1975	1976	1977	1978	1979	1980	1981
3.1.1 Compatibility of molybdenum and molybdenum alloys with molten salts and Bi-Li-Th solutions							
3.1.1.1 Thermal convection loop tests in molten salt							
3.1.1.2 Forced circulation loop tests in Bi-Li-Th solutions							
3.1.1.3 Corrosion tests of molybdenum-coated components							
3.1.2 Compatibility of graphite with Bi-Li-Th solutions							
3.1.2.1 Penetration of graphite as a function of Li in bismuth and type of graphite							
3.1.2.2 Studies of intercalation compounds with graphite							
3.1.2.3 Solubility of carbon in Bi-Li							
3.1.2.4 Thermal convection loop tests in Bi-Li							
3.1.2.5 Forced circulation loop tests in Bi-Li-Th solutions							
3.1.3 Compatibility of tantalum and tantalum alloys with molten salts and Bi-Li-Th solutions							
3.1.3.1 Thermal convection loop tests of Ta-10% W in molten salt							

Table 4.4.2 (continued)

	Fiscal year						
	1975	1976	1977	1978	1979	1980	1981
3.1.3.2 Forced circulation loop tests in molten salts							
3.1.3.3 Thermal convection loop tests in Bi-Li							
3.1.3.4 Forced circulation loop tests in Bi-Li-Th solutions							
3.1.4 Compatibility of braze alloys with molten salts and Bi-Li-Th solutions							
3.1.4.1 Capsule tests							
3.1.4.2 Thermal convection loop tests							
3.1.4.3 Forced circulation loop tests							

Table 4.4.3.1. Operating fund requirements for Task Group 3.1 - Determination of corrosion-resistant materials (costs in 1000 dollars)

	Fiscal year						
	1975	1976	1977	1978	1979	1980	1981
3.1.1 Compatibility of molybdenum and molybdenum alloys with molten salts and Bi-Li-Th solutions							
3.1.1.1 Thermal convection loop tests in molten salt		30					
3.1.1.2 Forced circulation loop tests in Bi-Li-Th solutions			50	70	75	35	
3.1.1.3 Corrosion tests of molybdenum-coated components		10	5				
Subtotal 3.1.1		40	55	70	75	35	
3.1.2 Compatibility of graphite with Bi-Li-Th solutions							
3.1.2.1 Penetration of graphite as a function of Li in bismuth and type of graphite	33						
3.1.2.2 Studies of intercalation compounds with graphite	20						
3.1.2.3 Solubility of carbon in Bi-Li	15						
3.1.2.4 Thermal convection loop tests in Bi-Li	20	80					
3.1.2.5 Forced circulation loop tests in Bi-Li-Th solutions			75	75	75	80	
Subtotal 3.1.2	88	80	75	75	75	80	

Table 4.4.3.1 (continued)

	Fiscal year						
	1975	1976	1977	1978	1979	1980	1981
3.1.3 Compatibility of tantalum and tantalum alloys with molten salts and Bi-Li-Th solutions							
3.1.3.1 Thermal convection loop tests of Ta-10% W in molten salt	30	15					
3.1.3.2 Forced circulation loop tests in molten salts			50	70	75		
3.1.3.3 Thermal convection loop tests in Bi-Li		30	10				
3.1.3.4 Forced circulation loop tests in Bi-Li-Th solutions					34	80	
Subtotal 3.1.3	30	45	60	70	109	80	
3.1.4 Compatibility of braze alloys with molten salts and Bi-Li-Th solutions							
3.1.4.1 Capsule tests		15	8				
3.1.4.2 Thermal convection loop tests		5	2				
3.1.4.3 Forced circulation loop tests				5	5	5	
Subtotal 3.1.4		20	10	5	5	5	
Total operating funds for Task Group 3.1	118	185	200	220	264	200	

Table 4.4.3.2. Capital fund requirements for work in Task Group 3.1 —
 Determination of corrosion resistant materials
 (costs in 1000 dollars)

	Fiscal year				
	1975	1976	1977	1978	1979
3.1 Determination of corrosion resistant materials					
3.1.1.2 Forced circulation loop test in Bi-Li-Th (molybdenum)			800*		
3.1.1.3 Corrosion tests of molybdenum coated components		10			
3.1.2.4 Thermal convection loop tests		75			
3.1.2.5 Forced-circulation loop tests with Bi-Li solutions (graphite)			450		
3.1.3.2 Forced-circulation loop tests with molten salt (tantalum)			800*		
3.1.3.4 Forced-circulation loop tests with Bi-Li-Th solutions (tantalum)				800*	
Total capital fund requirements for Task Group 3.1		85	450		

* Construction of these facilities will not be required if graphite is shown to be a satisfactory material for fuel processing systems.

4.4.5.2 Subtask 3.1.1.2 Forced-circulation loop test with Bi-Li-Th solutions

Previous thermal-convection loop tests have shown that molybdenum is compatible with Bi-Li solutions under dynamic conditions. Additional forced-circulation loop tests will allow further testing under conditions more closely simulating processing conditions, and a molybdenum loop will be constructed as a test-bed facility. The design of the loop will allow for removal of samples that will be exposed under varying conditions. Solutions of Bi-Li-Th containing fission product elements will be circulated at variable flow rates, and corrosion rates of molybdenum will be determined as a function of flow rate, fluid composition, and temperature difference.

4.4.5.3 Subtask 3.1.1.3 Corrosion tests of molybdenum-coated components

The coating of conventional materials such as iron- or nickel-base alloys with molybdenum, which does not require complicated fabrication and joining procedures, has been under consideration as a technique for providing resistance to corrosion by Bi-Li solutions. Two types of coating processes have been investigated thus far: chemical-vapor deposition by hydrogen reduction of MoF_6 and deposition from molten-salt mixtures containing MoF_6 by chemical reaction with the substrate. The latter method looks especially promising because more complicated components could probably be coated using this approach. Investigations of coating processes and variables will be continued. The effectiveness can best be determined from compatibility tests in Bi-Li solution. Both static and thermal-convection loop tests will be conducted and evaluation will consist primarily of chemical analyses of the solutions and metallographic examination of the coated samples.

4.4.6 Task 3.1.2 Compatibility of graphite with Bi-Li-Th solutions

4.4.6.1 Subtask 3.1.2.1 Penetration of graphite as a function of lithium concentration and type of graphite

The purpose of this subtask is to determine the types of graphite that will be satisfactory for use in constructing fuel processing systems and experiments which contain Bi-Li solutions. Compatibility tests have shown that bismuth and Bi-Li solutions penetrate the accessible porosity of some graphites, and in several tests with low-quality graphite Bi-Li solutions have penetrated the graphite completely. Capsule tests will be continued to determine the extent of penetration as a function of time, graphite pore size, graphite density, and the concentrations of lithium and fission product elements in Bi-Li solutions. The effectiveness of liquid impregnation, pyrolytic coatings, and refractory-metal coatings for reducing the extent of penetration will be evaluated. Studies will also be carried out in which graphites that are permeated by bismuth solutions are thermal cycled over a temperature range including the solution solidus temperature in order to determine the allowable extent of permeation.

4.4.6.2 Subtask 3.1.2.2 Studies to determine whether Bi-Li-Th solutions interact chemically with graphite

Some materials react with graphite to form lamellar or intercalation compounds. These compounds are formed by chemical interaction at the edge of the carbon layer planes and diffusion of the reactant into the graphite between the layer planes. Compounds of this type are known to form with a large number of salts, a few oxides, fluorine, chlorine, bromine, potassium, rubidium, and cesium.¹³⁻¹⁵ Experiments conducted thus far have not shown intercalation compound formation with Bi-Li solutions at 650°C. Studies will be continued to investigate the effect of temperature and the presence of fission product elements such as cesium in Bi-Li solutions on intercalation compound formation. Studies will also be carried out for determining the extent to which elements dissolved in bismuth interact with graphite to form metal carbides, and for observing the effect of carbide formation on the properties of the base graphite.

4.4.6.3 Subtask 3.1.2.3 Determination of the solubility of carbon in Bi-Li solutions

The solubility of carbon in bismuth has been reported¹⁶ to be <5 ppm at 750°C. In a thermal-convection-loop test in which graphite was in contact with Bi-100 ppm Li for 3000 hr at 700°C (max) and with a 100°C temperature difference between the hot and cold legs, corrosion and mass transfer were not significant. However, recent capsule test results at 650°C have indicated significantly higher carbon solubilities in Bi-3 wt % Li. Because rapid mass transfer kinetics have been observed in bismuth systems with materials having solubilities ranging from 50 to 100 ppm, it is important that the solubility of carbon in Bi-Li solutions be more accurately determined. One important factor in the determination is protection of the Bi-Li samples from exposure to air following equilibration with graphite. When lithium is exposed to air, a surface product believed to be Li_2CO_3 results. Thus, spuriously high carbon values can be obtained if proper sampling and analysis techniques are not used. Samples of various types of graphite will be exposed to Bi-100 wt ppm Li, Bi-1 wt % Li, Bi-2 wt % Li and Bi-3 wt % Li for 1000 and 3000 hr at 650°C. Carbon concentrations in the melt will be determined as a function of Li concentration, equilibration time, and type of graphite.

4.4.6.4 Subtask 3.1.2.4 Thermal-convection loop tests with Bi-Li solutions

One of the principal compatibility problems between graphite and bismuth is mass transfer in systems having a temperature gradient. Rapid kinetics of dissolution and deposition have resulted in significant mass transfer of iron and niobium even though their solubilities in bismuth are only 50-100 ppm at 600 to 700°C. If the solubility of graphite is appreciable in bismuth containing 2 to 3 wt % Li, mass transfer of graphite may be a

significant problem. Graphite samples will be evaluated initially in a molybdenum thermal-convection loop in which Bi-3 wt % Li will be circulated at a 700°C maximum temperature. When satisfactory joining procedures have been developed, a graphite loop will be constructed and the test will be repeated with a Bi-3 wt % Li solution. Tests will be continued to evaluate several grades of graphite using Bi-Li solutions, which in some cases will contain fission-product elements.

4.4.6.5 Subtask 3.1.2.5 Forced-circulation loop tests with Bi-Li solutions

These tests will be an extension of those described above in Subtask 3.1.2.4. The approach will be to construct a graphite loop test-bed facility in which samples of various types of graphite can be included. Variables will include flow rate, temperature difference, and composition of the Bi-Li solutions.

4.4.7 Task 3.1.3 Compatibility of tantalum and tantalum alloys with molten salts and Bi-Li solutions

4.4.7.1 Subtask 3.1.3.1 Thermal-convection loop test with molten salt

The thermodynamic stability of TaF₂ at 600-700°C is comparable to that of CrF₂. Since the activity of tantalum in unalloyed tantalum or Ta-10% W is higher than that of chromium in Hastelloy N, its corrosion rate will probably be somewhat higher for a given redox potential than that for chromium, and the rate of attack will not be diffusion limited as would be the case for attack of chromium in Hastelloy N. A series of thermal-convection loop tests will be carried out to evaluate tantalum and tantalum alloys. Initially, a loop will be constructed of the alloy 90% Ta-10% W which will be used to circulate MSBR fuel carrier salt at a maximum temperature of 700°C with a temperature difference of approximately 100°C. Tabular and tensile specimens will be included in both the hot- and cold-leg sections. Evaluation will consist of weight and mechanical properties changes, chemical analyses, and metallographic examination. Additional tests as indicated will be conducted in which time and alloy material are varied.

4.4.7.2 Subtask 3.1.3.2 Forced-circulation loop tests with molten salt

These tests will be an extension of those described above in Subtask 3.1.3.1, with conditions more closely simulating a fuel processing system. A test-bed facility will be constructed of the most promising tantalum alloy and test variables will include time, flow rate, temperature difference, and U⁺⁴/U⁺³ ratio. Removable samples will be included in several sections of the loop.

4.4.7.3 Subtask 3.1.3.3 Thermal-convection loop tests with Bi-Li-Th solutions

In thermal-convection loop tests of T-111 in Bi-2.5 wt % Li, mass transfer rates were low (comparable to those for molybdenum). If the results from tests with Ta-10% W in molten salt are promising (Subtask 3.1.3.1) a thermal-convection loop will be constructed of Ta-10% W to circulate Bi-2.5 wt % Li at 700°C (maximum) with a 100°C temperature difference. Test coupons and tensile specimens will be included in both hot and cold sections. In addition to mechanical properties changes, evaluation of components will be made by weight change measurements, chemical analyses, and metallographic examination. Additional tests will be necessary to evaluate the effect of Bi-Li composition including the addition of fission product elements.

4.4.7.4 Subtask 3.1.3.4 Forced-circulation loop tests with Bi-Li-Th solutions

Forced-circulation loop tests using Bi-Li-Th solutions will be required to more closely simulate processing conditions. A tantalum alloy loop (probably Ta-10% W) will be constructed as a test-bed facility in which removable samples can be exposed under varying conditions. Solutions of Bi-Li-Th containing fission product elements will be circulated at variable flow rates. Corrosion rates of tantalum alloys will be measured as a function of solution composition, flow rate, temperature, and temperature difference.

4.4.8 Task 3.1.4 Compatibility of braze alloys with molten salts and Bi-Li-Th solutions

Brazing will be a very important joining process in making graphite-to-graphite, graphite-to-molybdenum and, perhaps, molybdenum-to-molybdenum joints. Although it is likely that some portions of a processing plant will require brazed-joint construction, the use of tantalum alloys will not be as dependent on development of a braze alloy because tantalum alloys are more readily weldable than other potential materials of construction. One of the major requirements of a braze alloy is compatibility with molten salt and Bi-Li-Th solutions. In addition, for joints involving molybdenum, the melting point of the braze alloy should be low enough that molybdenum, which is structure sensitive, does not recrystallize during brazing. Alloys of Fe-C-B-Mo-Ge have shown promise for this application. Braze alloys for graphite generally consist of metals or alloys that are strong carbide formers such as molybdenum or titanium, but work with these materials has been limited.

4.4.8.1 Subtask 3.1.4.1 Capsule tests

Initial brazed-joint evaluation will consist of exposure of samples to salt mixtures or Bi-Li solutions in isothermal capsules, and this type of screening evaluation will eliminate alloys which show little promise. Conditions such as time, temperature and composition of the fluids will be varied.

4.4.8.2 Subtask 3.1.4.2 Thermal-convection loop tests

Braze alloys which show promise in the screening compatibility tests will be evaluated further in the thermal-convection loop tests described in Subtasks 3.1.1.1, 3.1.2.4, and 3.1.3.1. Initially, brazed-joint test coupons will be evaluated, but subsequently, loops will be constructed with brazed joints and these will be evaluated as a function of braze-alloy composition, time, and fluid composition.

4.4.8.3 Subtask 3.1.4.3 Forced-circulation loop tests

This is an extension of Subtask 3.1.4.2, above. Brazed joints will be included as samples in several sections of the test-bed loops described in Subtasks 3.1.1.2, 3.1.2.5, and 3.1.3.2. The variables to be studied will consist of temperature, temperature difference, time, flow velocity, and composition of the fluid.

4.5 TASK GROUP 3.2 DEVELOPMENT OF FABRICATION AND JOINING TECHNIQUES

4.5.1 Objective

The purpose of this task group is to develop fabrication and joining techniques for materials that will be used in constructing large-scale engineering fuel processing experiments. These studies will also prove valuable in making the final selection of materials to be used in constructing a fuel processing facility.

4.5.2 Schedule

The schedule for this task group is shown in Table 4.5.2.

4.5.3 Funding

Operating fund requirements for this task group are shown in Table 4.5.3.1, and capital equipment fund requirements are shown in Table 4.5.3.2.

4.5.4 Facilities

This task group will require the use of the following facilities:

Table 4.5.2. Schedule for work in Task Group 3.2 - Development of fabrication and joining techniques

	Fiscal year						
	1975	1976	1977	1978	1979	1980	1981
3.2.1 Fabrication development of molybdenum and molybdenum alloys							
3.2.1.1 Effect of very low concentrations of oxygen and carbon on deformation behavior							
3.2.1.2 Effect of fabrication processes and variables on the mechanical properties							
3.2.1.3 Grain size control during secondary fabrication processes							
3.2.1.4 Molybdenum alloy studies to improve ductility of base material							
3.2.2 Fabrication development of tantalum and tantalum alloys							
3.2.3 Fabrication development of graphite							
3.2.3.1 Evaluation of resistance of commercially available graphites to penetration by bismuth							
3.2.3.2 Development and evaluation of procedures to reduce bismuth penetration in commercial graphite							

Table 4.5.2 (continued)

	Fiscal year						
	1975	1976	1977	1978	1979	1980	1981
3.2.4 Joining of molybdenum and molybdenum alloys							
3.2.4.1 Development of molybdenum alloy with improved resistance to contamination induced embrittlement and/or cracking							
3.2.4.2 Effect of joining processes and variables on welding and mechanical properties							
3.2.4.3 Braze alloy development studies							
3.2.4.4 Mechanical joint development							
3.2.5 Joining of tantalum and tantalum alloys							
3.2.5.1 Effect of joining processes and variables on welding and mechanical properties							
3.2.5.2 Brazing development studies							
3.2.6 Joining of graphite							
3.2.6.1 Brazing development studies							
3.2.6.2 Adhesive bonding studies							
3.2.6.3 High-temperature diffusion bonding studies							
3.2.6.4 Mechanical joint studies							

Table 4.5.3.1. Operating fund requirements for Task Group 3.2 - Development of fabrication and joining techniques (costs in 1000 dollars)

	Fiscal year						
	1975	1976	1977	1978	1979	1980	1981
3.2.1 Fabrication development of molybdenum and molybdenum alloys							
3.2.1.1 Effect of very low concentrations of oxygen and carbon on deformation behavior		25	30				
3.2.1.2 Effect of fabrication processes and variables on the mechanical properties		10	10	15			
3.2.1.3 Grain size control during secondary fabrication processes		15	10				
3.2.1.4 Molybdenum alloying studies to improve ductility of base material			10	15	20	50	
Subtotal 3.2.1		50	60	30	20	50	
3.2.2 Fabrication development of tantalum and tantalum alloys				16	20	20	
Subtotal 3.2.2				16	20	20	
3.2.3 Fabrication development of graphite							
3.2.3.1 Evaluation of the resistance of commercially available graphites to penetration by bismuth		5					

Table 4.5.3.1 (continued)

		Fiscal year						
		1975	1976	1977	1978	1979	1980	1981
3.2.3.2	Development and evaluation of procedures to reduce bismuth penetration in commercial graphite		5	10				
Total 3.2.3			10	10				
3.2.4	Joining of molybdenum and molybdenum alloys							
3.2.4.1	Development of molybdenum alloy with improved resistance to contamination induced embrittlement and/or cracking			15	10	5		
3.2.4.2	Effect of joining processes and variables on welding and mechanical properties			10	15	10		
3.2.4.3	Braze alloy development studies		15	18				
3.2.4.4	Mechanical joint development				5	10		
Subtotal 3.2.4			15	43	30	25		
3.2.5	Joining of tantalum and tantalum alloys							
3.2.5.1	Effect of joining processes and variables on welding and mechanical properties				5	15	5	
3.2.5.2	Brazing development studies				5	15	10	
Subtotal 3.2.5					10	30	15	

Table 4.5.3.1 (continued)

	Fiscal year						
	1975	1976	1977	1978	1979	1980	1981
3.2.6 Joining of graphite							
3.2.6.1 Brazing development studies		10	10	30	10		
3.2.6.2 Adhesive bonding studies		10	10	20			
3.2.6.3 High-temperature diffusion bonding studies			5	20	40	15	
3.2.6.4 Mechanical joint studies			5	10	20		
Subtotal 3.2.6		20	30	80	70	15	
Total operating funds for Task Group 3.2		95	143	166	165	100	

Table 4.5.3.2. Capital fund requirements for work in Task Group 3.2 -
 Development of fabrication and joining techniques
 (costs in 1000 dollars)

	Fiscal year				
	1976	1977	1978	1979	1980
3.2 Development of fabrication and joining techniques for materials selected for engineering experiments					
3.2.1.2 Determine the effect of fabrication processes and variables on the mechanical properties		100			
3.2.1.4 Molybdenum alloying studies to improve ductility of base material			125		
3.2.2 Fabrication development of tantalum and tantalum alloys				20	
3.2.4.1 Development of molybdenum with improved resistance to contamination-induced embrittlement and/or cracking		10			
3.2.4.2 Determine the effect of joining processes variables on welding and mechanical properties		10			
3.2.6.3 High-temperature diffusion-bonding studies		30			
3.2.6.4 Mechanical-joint studies		20			
Total capital equipment funds for Task Group 3.2		170	125	20	

Bldg. 4508, Rm. 225 -- All electron beam welding will be done with the 6-KW Hamilton Standard electron-beam welder in this room.

Bldg. 4508, Rm. 226 -- Gas tungsten-arc welding (including Spot Varestraint tests) will be carried out in the glove box in this room. It will be necessary to provide an impurity addition and monitoring system for the chamber in order to conduct Subtask 3.2.4.1.

Bldg. 4508, Rm. 223 and Rm. 224 -- Brazing studies will be carried out in the furnaces in these rooms.

Bldg. 4508, Rm. 130 -- Fabrication studies will be carried out using the facilities of the Casting and Forming Technology Group. These include arc and electron-beam melting furnaces, vacuum heat treating furnaces, swagers, cold and hot rolling equipment, and a horizontal extrusion press.

Bldg. 3012 -- Tube reducing and large-size plate and sheet rolling will be done with the equipment in this building.

Some work will be done in conjunction with commercial vendors and will require use of their facilities.

4.5.5 Task 3.2.1 Fabrication development of molybdenum and molybdenum alloys

The objective of this task is to evaluate the existing processes for fabrication of molybdenum and to develop improved methods and materials that will facilitate the use of molybdenum or molybdenum alloys in fuel processing systems.

4.5.5.1 Subtask 3.2.1.1 Effect of very low concentrations of oxygen and carbon on deformation behavior

Very little work has been published on the effects of very low concentrations of oxygen and carbon on the deformation behavior of molybdenum. Recent advances in melting technology have resulted in production of very-high-purity base metal which causes variations in the required parameters for deformation. The levels of both oxygen and carbon dictate the temperature required for forming and the forces that are necessary. Impurity levels also have an effect on grain size of the starting blank which in turn changes the fabrication parameters. The effects of impurity levels will be studied by extrusion, back extrusion and tube drawing of selected heats of material, and by comparison of the fabrication parameters required for each material. Products will be evaluated visually and metallographically to determine grain size and microstructure.

4.5.5.2 Subtask 3.2.1.2 Effect of fabrication processes and variables on mechanical properties

In order to assist in the design and construction of molybdenum components for processing systems, it will be necessary to investigate the effect of fabrication processes and variables on mechanical properties. Little mechanical properties data is available on molybdenum product forms except for small diameter rod and sheet. This effort will use extrusion, back extrusion and tube drawing to produce a wide range of specimens for evaluation. Fabrication variables will include forming temperatures, deformation rates and in-process heat treatment. Mechanical properties tests will include measurements of toughness, tensile strength, and ductility as a function of temperature and strain rate.

4.5.5.3 Subtask 3.2.1.3 Grain size control during secondary fabrication processes

Fine-grained molybdenum generally is easier to fabricate and has better mechanical properties than material having a larger grain size. In order to facilitate making molybdenum components for processing systems, it will be necessary to carry out studies on the control of grain size during secondary fabrication. Rotary forging of large-diameter pipe, back extrusion of shapes, and tube drawing will be used in the study. The effort will be of much wider scope than that used previously on the production of commercial arc-cast tubing.⁷

4.5.5.4 Subtask 3.2.1.4 Molybdenum alloying studies to improve ductility of base material

Little, if any, work has been published on the alloying of molybdenum to improve ductility because most work has been directed towards increasing the base-metal strength. This effort will evaluate the effectiveness of small alloying additions for cleaning up grain boundaries and controlling grain size. Elements such as yttrium, hafnium, titanium, and zirconium have sometimes proved effective as oxygen and carbon scavengers. Rare-earth and boron additions have been reported¹⁷ to improve crack resistance. The addition of rhenium improves the ductility of molybdenum considerably, and the alloy Mo-50% Re is reasonably fabricable and weldable. However, high cost and limited availability of rhenium make this alloy less desirable. Alloys containing small concentrations of rhenium in combination with other elements such as those discussed above will be investigated.

4.5.6 Task 3.2.2 Fabrication development of tantalum and tantalum alloys

Tantalum and tantalum-base alloys are not considered to be difficult to fabricate because of their good ductility. After a particular tantalum-base alloy has been selected for use in fuel processing systems, work in

this subtask will be carried out to review fabrication process methods and to determine optimum process parameters. In addition, the effect of surface contamination during forming and fabrication will be determined. The effect of surface coatings used for both protection and lubrication during forming will be evaluated by chemical analysis and changes in mechanical properties. Methods of fabrication will include extrusion, rolling, and drawing. Minor base-metal and alloy additions will be investigated to determine whether they improve fabrication parameters and products.

4.5.7 Task 3.2.3 Fabrication development of graphite

The main fabrication problem associated with graphite for this application is making it impervious to penetration by Bi-Li solutions. Since the graphite used in chemical processing systems will not be exposed to significant neutron fluences, graphites of poor crystalline perfection can be used. Rather than making the entire graphite body impervious, the fabricated components will be surface sealed by liquid or gaseous impregnation.

4.5.7.1 Subtask 3.2.3.1 Evaluation of the resistance of commercially available graphites to penetration by bismuth-lithium solutions

Compatibility tests have shown that Bi-Li solutions will penetrate the open porosity of some types of graphite while high-density, low-porosity graphites almost completely resist penetration. Determination of the type of graphite required for fuel processing experiments and plant construction is the objective of Subtask 3.1.2.1. Based on results from that work, commercial graphite that is available in the size ranges that are required for fuel processing applications will be evaluated by exposure to Bi-Li solutions. Since pore size and pore accessibility of commercial graphites often vary considerably, one important factor in this study will be a statistical determination of the variability of these characteristics for a particular grade of graphite.

4.5.7.2 Subtask 3.2.3.2 Development and evaluation of procedures to reduce bismuth penetration in commercial graphite

If commercially available graphites do not adequately resist penetration by Bi-Li solutions, suitable sealing procedures will be developed. Emphasis will be on conventional techniques that can be used by vendors during fabrication or that are adaptable to complex system designs. The sealing techniques of interest would primarily include liquid hydrocarbon impregnation methods.

4.5.8 Task 3.2.4 Joining of molybdenum and molybdenum alloys

The objective of this subtask is to evaluate existing processes for joining molybdenum and to develop improved techniques and materials that will facilitate the use of molybdenum or molybdenum alloys in fuel processing systems.

4.5.8.1 Subtask 3.2.4.1 Development of molybdenum having improved resistance to contamination-induced embrittlement and/or cracking

Welded molybdenum joints are generally brittle and somewhat fragile at temperatures up to 200 to 400°C. This has been attributed to the presence of carbides, oxides and nitrides, even at very low concentrations.¹⁷⁻²¹ Oxygen has been found to be particularly harmful in causing weld cracking because it apparently forms low-melting films with molybdenum that lead to grain boundary separation. Recent advances in melting technology have allowed the production of very-high-purity base material. However, impurities are generally introduced during welding and studies will be undertaken to evaluate the effect of alloying elements on reducing the tendency for hot cracking and for increasing the room temperature ductility of the weldments. There is evidence¹⁷ that the rare-earth elements and boron may have beneficial effects, and molybdenum alloys containing these elements will be evaluated initially. Standard weld-cracking tests (e.g., spot Vareststraint) will be used to evaluate weldability. Ductility and toughness will be measured as a function of strain rate and temperature.

4.5.8.2 Subtask 3.2.4.2 Effect of joining processes and variables on welding and mechanical properties

In order to assist in the design and construction of molybdenum components for a processing system, it is necessary that studies be carried out to determine how various joining processes (e.g., gas tungsten-arc and electron-beam welding) and the procedural variables in a given joining process affect the weldability of a particular molybdenum base metal. Work of this type is quite important prior to system design so that components can be built utilizing the optimum welding process, joint geometry, etc. Additionally, the mechanical properties (particularly toughness and ductility) of any candidate materials will be determined, especially in the welded condition. This effort will be similar to that carried out previously on commercial arc-cast tubing,⁷ but it would also include other welding processes and procedural variables for a given process as well as for other base-metal forms such as sheet.

4.5.8.3 Subtask 3.2.4.3 Braze-alloy development studies

Although an iron-base alloy of the composition Fe-Mo-Ge-C-B (75-15-5-4-1 wt %) was previously developed which has good brazing characteristics and adequate resistance to bismuth corrosion at 650°C, further development is

needed in this area. This alloy has several undesirable characteristics which make its use difficult, such as a tendency to crack on cooling after brazing and a brazing temperature that is above the recrystallization temperature of molybdenum. Studies will initially emphasize modification of this alloy to improve these characteristics. However, a more nearly corrosion-resistant alloy would be desirable and later studies will emphasize development of an entirely new braze material. Braze alloys will be evaluated to determine their wettability, flowability, mechanical properties and corrosion resistance to salt mixtures and Bi-Li solutions.

4.5.8.4 Subtask 3.2.4.4 Mechanical joint development

The development of mechanical joints could be an important factor in constructing complex systems with molybdenum. Previous work⁷ has shown that resealable mechanical couplings can be made. The objective of this subtask will be to extend the previous developmental work to joint sizes that would be required in experimental and actual process equipment. These studies would also seek to improve reliability and leak tightness of couplings. Joint design and seals are two important factors that will be considered.

4.5.9 Task 3.2.5 Joining of tantalum alloys

The object of this subtask is to provide joining information on specific tantalum alloys selected for engineering experiments on fuel processing.

4.5.9.1 Subtask 3.2.5.1 Effect of joining processes and variables on welding and mechanical properties

Tantalum and tantalum alloys are not generally considered to be difficult to weld. Once a particular tantalum alloy is selected for a fuel processing application, it would be the purpose of this subtask to review joining process methods and determine optimum process parameters for the application. The basic welding method to be used would be gas tungsten-arc and the variables to be optimized would be heat input, travel speed, welding current and the method of filler-metal addition. In addition, the effect of surface preparation and pre- and post-weld heat treatments will be determined. Evaluation of weld joints will consist of penetrant examination, helium leak tests before and after thermal cycles, Vickers tests and ductility and toughness measurements as a function of strain rate and temperature.

4.5.9.2 Subtask 3.2.5.2 Brazing development studies

If brazed joints are to be utilized with tantalum-base materials in processing systems, a braze alloy must be developed. The principal

requirements for such an alloy would be corrosion resistance and mechanical strength and ductility. Brazing temperature would not be as critical as with molybdenum because tantalum alloys do not suffer such a sharp drop in ductility upon recrystallization. Initially, the wettability and flowability characteristics of several alloys will be evaluated visually and metallographically. After these screening tests, brazed samples will be exposed to molten-salt mixtures and Bi-Li solutions in isothermal capsule tests. The mechanical strength and ductility of the most promising alloys will then be determined as a function of temperature. Finally, samples will be exposed to molten-salt mixtures and Bi-Li solutions in flow systems that simulate actual processing conditions.

4.5.10 Task 3.2.6 Joining of graphite

One of the requirements for the use of graphite in fuel processing applications is the development of joining techniques. Several types of joints involving graphite are anticipated such as graphite-to-graphite and graphite-to-refractory metal.

4.5.10.1 Subtask 3.2.6.1 Brazing development studies

A prime difficulty in brazing graphite to graphite and to metals is the differences in coefficient of thermal expansion between the graphite, the brazing alloys, and the metals. In addition, one must also consider the extreme difficulty in obtaining adequate wetting and flow. Other requirements are adequate strength, suitable ductility, and good corrosion resistance.

A limited number of brazing alloys have been developed at ORNL which contain a sufficient amount of carbide-forming elements to adequately braze graphite to itself and to metal. Graded-transition joints have also been developed at ORNL and these appear to be suitable for overcoming large mismatches in expansion.²² However, none of the brazing alloys or transition joints have been corrosion tested in bismuth-lithium solutions or molten-salt mixtures, and a development and testing program will be required.

Initially, the program will consist of compatibility testing of the existing graphite-brazing alloys, and, based on these results, further alloys may be developed. The subsequent brazing-alloy development work will utilize the best-known corrosion-resistant materials, and alloys will be formulated that melt and flow in the proper temperature range and which wet and flow on graphite. These alloys will then be tested for compatibility with the appropriate environments (see Section 4.4.8, Task 3.1.4).

4.5.10.2 Subtask 3.2.6.2 Organic-cemented joint development

Various cements (such as those containing furfural alcohol), joint designs, and curing techniques have been developed for HTGR applications. The purpose of that work was to obtain cemented carbonaceous joints of the lowest-possible permeability. In the HTGR study it was found that joint thickness must be kept at a minimum, preferably at about 0.020-in. Uniform joint clearances are necessary, and a load of about 200 psi must be applied to the pieces being joined while the cement cures. Strict control over cement preparation must be maintained, and the rate of heating during carbonizing must be carefully controlled.

No evaluations of this type of joint have been performed for chemical processing applications, and a compatibility and mechanical property test program involving sample joints will be conducted. It will consist initially of a review of commercial practices and the construction and evaluation of prototype joints. The evaluation will consist of metallographic examination, leak testing, corrosion testing and determination of high-temperature mechanical properties.

4.5.10.3 Subtask 3.2.6.3 High-temperature diffusion-bonding studies

Solid-state joints of the diffusion-bonding type have been made, but there is considerable difficulty in making engineering components using this method. Most diffusion bonding applications utilize some deformation or plastic flow of the base materials during bonding. Two of the most important considerations are joint design and selection of a carbide-forming filler metal. A development and evaluation program will be required before suitable procedures can be formulated. Leak tightness, mechanical strength, and corrosion resistance will be determined as a function of time, temperature, pressure, and surface finish with various intermediate filler metals such as tantalum, niobium, and titanium.

4.5.10.4 Subtask 3.2.6.4 Mechanical joint studies

The development of high-reliability, leak-tight mechanical joints for attaching graphite to graphite and to metals would be extremely beneficial, and only limited information in this area is available.

An attractive alternate approach is that of combining a mechanical joint with brazing. The mechanical joint would provide additional strength while the braze material would provide leak-tightness. Development work will be carried out to investigate these possibilities. The work will consist of evaluating existing joint designs for fuel processing engineering systems. Leak tightness will be measured as a function of temperature and thermal cycles. Based on these tests, second generation designs will be developed and evaluated. Key requirements for these joints will be reliability (leak-tightness), mechanical strength, and low cost.

4.6 TASK GROUP 3.3 CONSTRUCTION OF ENGINEERING FUEL PROCESSING EXPERIMENTS

4.6.1 Objective

The objective of this task is to provide information on materials relative to the design and construction of engineering fuel processing experiments. In addition, a surveillance program will be carried out to evaluate the effect of fuel processing conditions on materials properties.

4.6.2 Schedule

The schedule for work in this task group is shown in Table 4.6.2.

4.6.3 Funding

Operating fund requirements for this task group are shown in Table 4.6.3.

4.6.4 Facilities

Facilities as specified in subsection 4.5.4, will be used in the development of materials fabrication and joining processes which will be applicable to work in this task group.

4.6.5 Task 3.3.1 Continuous Fluorinator Experimental Facility

The objective of this work is to provide and evaluate surveillance specimens for a facility in which continuous frozen-wall fluorinators will be tested, and to evaluate the extent to which a frozen-salt layer protects the fluorinator material of construction (L-nickel) by allowing passivation of the nickel to occur. A description of the facility is given in Task 2.2.6 (see Section 3).

4.6.5.1 Subtask 3.3.1.1 Evaluation of surveillance specimens

A series of surveillance specimens will be exposed in the Continuous Fluorinator Experimental Facility to evaluate the effect of fluorine-molten salt and hydrogen-molten salt environments on corrosion rate. Variables will include flow rates, temperature, and concentration of UF_4 in the salt feed. One of the principal objectives of work in this facility is to demonstrate frozen-wall corrosion protection in continuous fluorinators. Therefore, the changes in wall thickness of the fluorinator material (nickel) will be monitored using non-destructive techniques such as eddy-current measurements. A comparison of results for the surveillance specimens with those for the fluorinator wall material will indicate the extent to which corrosion protection is provided by the frozen-salt layer which should allow passivation of the nickel to occur.

Table 4.6.2. Schedule for work in Task Group 3.3 - Construction of fuel processing experiments

	Fiscal year												
	1975	1976	1977	1978	1979	1980	1981	1982	1983	1984	1985	1986	
3.3.1 Continuous Fluorinator Experimental Facility													
3.3.1.1 Evaluation of surveillance specimens													
3.3.2 Fluorinator-Reconstitution Experimental Facility													
3.3.2.1 Evaluation of surveillance specimens													
3.3.3 Reductive Extraction Process Facility													
3.3.3.1 Fabrication process procedures and parameters													
3.3.3.2 Joining processes and parameters													
3.3.3.3 Construction													
3.3.3.4 Evaluation of surveillance specimens													
3.3.4 Metal Transfer Process Facility													
3.3.4.1 Fabrication process procedures and parameters													
3.3.4.2 Joining processes and parameters													
3.3.4.3 Construction													
3.3.4.4 Evaluation of surveillance specimens													
3.3.5 Integrated Process Test Facility													
3.3.5.1 Fabrication process procedures and variables													
3.3.5.2 Joining processes and parameters													
3.3.5.3 Construction													
3.3.5.4 Evaluation of surveillance specimens													

Table 4.6.3. Operating fund requirements for Task Group 3.3 - Construction of processing experiments
(costs in 1000 dollars)

	Fiscal year											
	1975	1976	1977	1978	1979	1980	1981	1982	1983	1984	1985	1986
3.3.1 Continuous Fluorinator Experimental Facility												
3.3.1.1 Evaluation of surveillance specimens				10								
Subtotal 3.3.1				10								
3.3.2 Fluorinator-Reconstitution Experimental Facility												
3.3.2.1 Evaluation of surveillance specimens					10							
Subtotal 3.3.2					10							
3.3.3 Reductive Extraction Process Facility												
3.3.3.1 Fabrication process procedures and parameters	2	5										
3.3.3.2 Joining processes and parameters		5										
3.3.3.3 Construction		5	5									
3.3.3.4 Evaluation of surveillance specimens				10	10							
Subtotal 3.3.3	2	15	15	10	10							
3.3.4 Metal Transfer Process Facility												
3.3.4.1 Fabrication process procedures and parameters	2											
3.3.4.2 Determination of joining processes and parameters	1											
3.3.4.3 Construction		5										
3.3.4.4 Evaluation of surveillance specimens				5	10							
Subtotal 3.3.4	3	5	5	10	10							
3.3.5 Integrated Process Testing Facility												
3.3.5.1 Fabrication process procedures and variables				15	20	10						
3.3.5.2 Joining processes and parameters				5	25	25						
3.3.5.3 Construction						25	75	75	45			
3.3.5.4 Evaluation of surveillance specimens									30	30	30	30
Subtotal 3.3.5				20	45	60	75	75	75	30	30	30
Total operating funds for Task Group 3.3	5	20	50	75	60	75	75	75	30	30	30	

4.6.6 Task 3.3.2 Fluorination-Reconstitution Engineering Facility

The objective of this task is to provide materials data required for the construction of a facility in which a continuous fluorinator and equipment for fuel reconstitution are operated simultaneously, to provide corrosion surveillance specimens for exposure in the facility, and to evaluate the effect of process conditions on corrosion rate as indicated by the specimens and by equipment after its removal from the facility. A description of the facility is given in Task 2.2.7 (see Section 3).

4.6.6.1 Subtask 3.3.2.1 Evaluation of surveillance specimens

Surveillance specimens will be exposed to conditions closely akin to those expected in a processing plant. Longer term and more accurate compatibility measurements will be made. Weight and/or dimensional changes will be determined. In addition, metallographic examination, bulk chemical or surface analyses, and mechanical properties measurements will be made on selected samples. In-stream surveillance specimens will be compared to those protected by a frozen-salt layer.

4.6.7 Task 3.3.3 Reductive Extraction Process Facility

The objective of this work is to provide materials data required for the construction of a Reductive Extraction Process Facility and to evaluate the effect of molten salts and Bi-Li solutions on materials properties under process conditions.

4.6.7.1 Subtask 3.3.3.1 Determination of fabrication process procedures and parameters

A nickel-base alloy, graphite, and molybdenum have been proposed as materials of construction for various portions of the facility. The objective of this task will be to provide materials assistance during design of the system, which will involve primarily a review of the proposed fabrication procedures. Experimental work on materials will be limited to specific problem areas that may arise.

4.6.7.2 Subtask 3.3.3.2 Determination of joining processes and parameters

The principal objective of this task will be to provide design assistance relative to joining methods required for construction of components for the Reduction Extraction Process Facility. Engineering drawings will be reviewed and prototypic joints made where required.

4.6.7.3 Subtask 3.3.3.3 Construction

During construction of the Reductive Extraction Process Facility, materials assistance will be provided as required. Task Group 3.2 will be initiated in FY 1976, and the resulting baseline data will be helpful during construction, particularly if problems are encountered.

4.6.7.3 Subtask 3.3.3.4 Evaluation of surveillance specimens

During operation of the REPF, surveillance specimens will be examined periodically to determine the corrosion behavior of construction materials as a function of time under process conditions.

4.6.8 Task 3.3.4 Metal Transfer Process Facility

The objective of this task is to provide materials data required for construction of a facility for study of the removal of rare earths from MSBR fuel carrier salt. A description of this facility is given in Task 2.4.3 (see Section 3).

4.6.8.1 Subtask 3.3.4.1 Determination of fabrication process procedures and parameters

The principal objective of this subtask is to provide assistance relating to selection of materials for and design of the Metal Transfer Process Facility. Fabrication procedures will be reviewed and prototype components or parts made, if required.

4.6.8.2 Subtask 3.3.4.2 Determination of joining processes and procedures

The purpose of this subtask is to provide assistance relating to joining components for the Metal Transfer Process Facility. Engineering design drawings will be reviewed and joining procedures recommended. Experimental prototype joints will be constructed, if required.

4.6.8.3 Subtask 3.3.4.3 Construction

Materials assistance will be provided during construction of the Metal Transfer Process Facility. Design, fabrication and joining changes will be reviewed.

4.6.8.4 Subtask 3.3.4.4 Evaluation of surveillance specimens

Surveillance corrosion samples will be included in the Metal Transfer Process Facility and these will be evaluated at selected time intervals. Samples will be exposed to a molten fluoride salt containing rare-earth fluorides, Bi-Li solutions, LiCl, and HF-H₂ mixtures.

4.6.9 Task 3.3.5 Integrated Process Test Facility

The objective of this task is to provide design and fabrication assistance for construction of a nonradioactive process facility for demonstrating processes and equipment on a scale that is 25 to 75% of that required for a 1000-MW(e) MSBR. This subtask will include materials selection, design reviews, construction, and operation of a surveillance corrosion program. A description of the facility is given in Task Group 2.9 (see Section 3).

4.6.9.1 Subtask 3.3.5.1 Determination of fabrication process procedures and variables

Work conducted under Tasks 3.2.1, 3.2.2, and 3.2.3 will be aimed at providing basic information for material and fabrication process selection. In this subtask, prototypic components will be fabricated as required.

4.6.9.2 Subtask 3.3.5.2 Determination of joining processes and parameters

Tasks 3.2.4, 3.2.5, and 3.2.6 will be aimed at providing basic information on joining processes for the materials selected for construction of the Integrated Process Test Facility. Coordination of materials and design requirements will be a principal objective of this subtask. Prototypic joint components will be fabricated as required.

4.6.9.3 Subtask 3.3.5.3 Construction

Materials assistance will be provided as required during construction of the Integrated Process Test Facility. The work will principally consist of reviews of design, fabrication, and joining changes.

4.6.9.4 Subtask 3.3.5.4 Evaluation of surveillance specimens

Surveillance specimens will be included in the Integrated Process Test Facility and these will be periodically evaluated during operation of the facility. Since this is essentially a pilot plant facility, most process environments will be encountered under conditions that will be typical of actual plant operation.

REFERENCES FOR SECTION 4

1. A. P. Litman and A. E. Goldman, *Corrosion Associated with Fluorination in the Oak Ridge National Laboratory Fluoride Volatility Process*, ORNL-2832 (June 5, 1961).
2. L. Hays, R. Breyne, and W. Seefeldt, "Comparative Tests of L Nickel, D Nickel, Hastelloy B, and INOR-1," *Chemical Engineering Division Summary Report, July, August, September, 1958*, ANL-5924, pp. 49-52.
3. *The Development Status of Molten-Salt Breeder Reactors*, ORNL 4812, August 1972, pp. 195-218 and 331-363.
4. H. Shimotake, N. R. Stalica, and J. C. Hesson, "Corrosion of Refractory Metals by Liquid Bismuth, Tin, and Lead at 1000°C," *Trans. ANS* 10: 141-142 (June 1967).
5. J. W. Siefert and A. L. Lower, Jr., "Evaluation of Tantalum, Molybdenum, and Beryllium for Liquid Bismuth Service," *Corrosion* 17(10): 475t-78t (October 1961).
6. *MSR Program Semi-annual Progress Report February 29, 1972*, ORNL-4782.
7. J. R. DiStefano and A. J. Moorhead, "Development and Construction of a Molybdenum Test Stand," ORNL-4874, December 1972.
8. B. Fleischer, *Metals and Ceramics Division Annu. Progr. Rep. June 30, 1970*, ORNL-4570, pp. 103-4.
9. R. G. Donnelly and G. M. Slaughter, "The Brazing of Graphite," *Welding J.* 41(5): 461-69 (1962).
10. J. P. Hammond and G. M. Salughter, "Bonding Graphite to Metals with Transition Pieces," *Welding J.* 50(1): 33-40 (1970).
11. W. J. Hallett and T. A. Coultas, *Dynamic Corrosion of Graphite by Liquid Bismuth*, NAA-SR-188 (September 22, 1952).
12. A. L. Lowe, Jr. (Compiler), *Liquid Metal Fuel Reactor Experiment Graphite Evaluation Program*, BAW-1197 (June 1960).
13. G. R. Hennig, Interstitial Compounds of Graphite, in *Progress in Inorganic Chemistry*, vol. 1, pp. 125-205, Interscience Publishers, Inc., New York 1959.
14. W. Rudorff, Graphite Interclation Compounds, in *Advances in Inorganic Chemistry and Radiochemistry*, vol. 1, pp. 223-266, Academic Press, Inc., New York, 1959.

15. R. C. Croft, Lamellar Compounds of Graphite, *Quart. Revs. London* 14: 1-45 (1960).
16. C. B. Griffith and M. W. Mallett, *J. Am. Chem. Soc.* 75: 1832-1834 (1953).
17. E. M. Savitskii et al., "Rare Earth Alloys," AEC-tr-6151.
18. T. Perry, H. S. Spacil, and J. Wulff, "Effect of Oxygen on Welding and Brazing Molybdenum," *Welding Journal* 33(9): Research Suppl. 442-s to 448-s (1954).
19. W. N. Platte, "Influence of Oxygen on Soundness and Ductility of Molybdenum Welds," *Welding Journal* 35(8): Research Suppl. 369-s to 381-s (1956).
20. W. N. Platte, "Effects of Nitrogen on the Soundness and Ductility of Welds in Molybdenum," *Welding Journal* 36(6): Research Suppl. 301-s to 306-s (1957).
21. A. J. Moorhead and G. M. Slaughter, "Welding Studies on Arc-Cast Molybdenum," *Welding Journal*, 1974, to be published.
22. J. P. Hammond and G. M. Slaughter, "Bonding Graphite to Metals With Transition Pieces," *Welding Journal*, January 1971.

5. CHEMICAL RESEARCH AND DEVELOPMENT

5.1 INTRODUCTION

5.1.1 Objective

The objective of this activity is to obtain the chemical information necessary for the design of molten-salt breeder reactors. Work in this activity will include studies of fuel and coolant salt chemistry, measurements of required physical properties, studies relating to tritium management, delineation of operating parameters, and chemical studies related to off-design events such as temperature excursions or leaks. This activity will also provide chemical support during engineering development activities.

5.1.2 Scope

These laboratory-scale studies will involve detailed investigations of chemistry in MSBR fuel salt including measurement of solubility products for the actinide oxides, studies of the behavior of tellurium under various redox conditions, phase behavior of PuF_3 , fuel-coolant interactions, and determination of physical property data. Similarly, understanding of the chemistry of the coolant salt $\text{NaBF}_4\text{-NaF}$ (92-8 mole %) must be greatly enhanced. Oxide and hydroxide chemistry in fluoroborate will receive intensive study along with investigations of the corrosion chemistry of this salt, methods for purifying the salt, and measurements of physical properties. An assessment of alternate coolants will also be made. Tritium behavior in MSBR systems will also require major study. In addition to measurements of the permeability of various alloys to tritium, the possibility of sustaining an impermeable oxide film on the steam side of the steam generator will be fully explored. Measurements of the solubilities, diffusivities, etc. of T_2 and HT in fuel and coolant salts will be made to aid in predicting tritium behavior in an MSBR system. Studies of fission product chemistry will be focused chiefly on the chemistry of niobium, molybdenum, other noble metals, and iodine. The objective of these studies is the accurate prediction of fission product distribution in an MSBR system. Fundamental studies of $\text{LiF-BeF}_2\text{-ThF}_4$ mixtures will include determination of activity coefficients of both major and minor components of these systems. Porous electrodes will be used to study the chemistry of trace elements such as bismuth in MSBR fuel salt.

Work related to the chemistry of MSBR fuel processing is covered in Section 3 Fuel Processing.

5.2 PROGRAM BUDGET AND SCHEDULE

5.2.1 Schedule and key program milestones

The schedule for work on chemical research and development is shown in Table 5.2.1.1. The key program milestones for this activity are listed in Table 5.2.1.2 and occur at the times indicated in Table 5.2.1.1.

5.2.2 Budget summary

A summary of the operating budget is given in Table 5.2.2.1. Table 5.2.2.2 shows requirements for capital equipment funds.

5.3 REQUIREMENTS, BACKGROUND AND STATUS OF DEVELOPMENT

5.3.1 Requirements

5.3.1.1 Basis for fuel salt composition

The fuel salt for a single-fluid MSBR must satisfy a number of stringent requirements.¹ It must

- (1) have a low capture cross-section for neutrons,
- (2) dissolve more than a critical concentration of uranium or plutonium as well as high concentrations of thorium,
- (3) be thermally stable,
- (4) have a low vapor pressure at 600-750°C,
- (5) possess good heat-transfer and hydrodynamic properties,
- (6) be nonaggressive toward materials of construction,
- (7) be stable to reactor radiation,
- (8) tolerate fission product accumulation, and
- (9) be amenable to recovery of bred fissile material and removal of fission products.

Very few materials can meet these requirements. Fluoride salts of ⁷lithium and beryllium are among the few candidates for the molten salt. Various compositions of UF₄ and ThF₄ dissolved in mixtures of ⁷LiF and BeF₂ have been considered for the fuel salt. The most likely choice — and the present design composition — is LiF-BeF₂-ThF₄-UF₄ (71.7-16-12-0.3 mole %). The fuel salt composition has been thoroughly evaluated in the past and alternate fuel salts, with the exception of minor adjustments in composition or the possible substitution of PuF₃ for UF₄ in converter reactors or for MSBR startup, are not presently under consideration.

5.3.1.2 Basis for coolant salt composition

The coolant salt, used to transfer heat from the fuel salt to the steam-raising system, should meet a number of requirements and constraints² which include the following:

- (1) The consequences of an accidental mixing of coolant and fuel must be minimal and reversible. Primary heat exchangers cannot be guaranteed to be leak-free for the life of an MSBR plant; therefore, there is a finite probability that mixing of fuel salt and coolant will occur. The consequences of such mixing should not lead to dire consequences (such as nuclear excursions, chemical explosions, rapid corrosion, or failure of major plant components) and must be reversible. It is desirable that the expensive fuel salt not be rendered useless.
- (2) It would be highly beneficial and desirable if virtually all of the tritium diffusing into the coolant circuit was sequestered. This would aid in reducing the rate at which tritium transfers to the steam system and minimize the amount released to the environment. Because the fuel salt contains a high atomic density of lithium, a significant quantity of tritium [2420 curies per day in a 1000-MW(e) MSBR] is generated in the reactor core.³ Structural metals being considered for MSRs are permeable to tritium, and it is likely that a significant fraction of the tritium will diffuse into the coolant circuit.
- (3) The coolant must be compatible with components which it contacts normally. Only minimal corrosion of heat exchangers, pumps, steam generators, reheaters, storage tanks, etc., can be tolerated in normal operation or as a result of foreseeable leaks or operating excursions.
- (4) Small leaks in the steam-raising system must be tolerable, and not result in serious consequences. Steam leakage into the coolant should not result in violent reactions with the coolant nor render the coolant seriously corrosive. A practical means for reprocessing the coolant to remove water or its reaction products should be available. Coolant leaks into the steam system should not lead to serious corrosion such as stress-corrosion cracking.

Table 5.2.1.1. Schedule for work on chemical research and development

Chemical research and development	Fiscal year											
	1975	1976	1977	1978	1979	1980	1981	1982	1983	1984	1985	1986
4.1 Fuel salt chemistry		∇ ^a	∇ ^b	∇ ^c	∇ ^d			∇ ^e ∇ ^f				∇ ^g
4.2 Coolant salt chemistry	∇ ^h		∇ ⁱ	∇ ^j		∇ ^k	∇ ^l		∇ ^m			
4.3 Tritium behavior					∇ ⁿ	∇ ^o			∇ ^p	∇ ^q	∇ ^r ∇ ^s	
4.4 Fission product chemistry						∇ ^t	∇ ^u		∇ ^v	∇ ^w		
4.5 Fundamental studies of molten salts			∇ ^x	∇ ^y	∇ ^z							

Table 5.2.1.2. Key milestones for MSBR chemical research and development

Milestone	Description
a	Complete investigation of phase equilibria related to fuel-coolant mixing
b	Establish solubility of tellurium and tellurides in fuel salt
c	Determine reactions of Te_3^- with structural metals
d	Complete dynamic investigations of fuel-coolant interaction
e	Complete $\text{U}^{3+}/\text{U}^{4+}$ equilibria studies
f	Determine solubility of protactinium, neptunium, and thorium oxides in fuel salt
g	Complete physical property determinations on fuel salt
h	Submit interim report on alternate coolant evaluation
i	Complete evaluation of boride formation in Hastelloy N in contact with fluoroborate coolant
j	Submit final evaluation of alternate coolants
k	Complete investigation of oxide species in fluoroborate
l	Complete measurement of free energy of formation of corrosion products in fluoroborate coolant
m	Complete physical property determinations on coolants
n	Complete measurements of tritium permeation of clean and oxidized metals
o	Investigate equilibria between salt-gas systems and measure tritium solubility in fuel salt
p	Complete investigation of stability of oxide coatings in steam systems
q	Complete solubility measurements of T_2 and HT in fuel and coolant
r	Complete diffusivity measurements of T_2 and HT
s	Complete modeling of tritium behavior in MSBRs
t	Obtain full understanding of redox chemistry of noble metals and reactions with oxide ion and graphite
u	Reevaluate MSRE fission product deposition data
v	Investigate iodine distribution and decontamination of Hastelloy N
w	Complete studies in GSTF
x	Complete determination of activity coefficients in fuel salt
y	Complete evaluation of porous electrodes
z	Complete determination of the feasibility of porous electrodes for Bi removal from fuel salt

Table 5.2.2.1. Summary of operating fund requirements for work on chemical research and development
(costs in 1000 dollars)

	Fiscal year											
	1975	1976	1977	1978	1979	1980	1981	1982	1983	1984	1985	1986
4.1 Fuel salt chemistry	168	200	166	165	220	220	345	330	245	110	110	
4.2 Coolant salt chemistry	165	180	180	218	220	270	335	360	220	110	55	
4.3 Tritium behavior		55	105	165	220	270	325	515	550	365	275	
4.4 Fission product chemistry		75	110	165	214	254	250	245	215	25		
4.5 Fundamental studies of molten salts	140	200	250	200	140							
Total operating funds for chemical research and development	473	710	811	913	1014	1014	1255	1450	1230	610	440	

Table 5.2.2.2. Summary of capital equipment fund requirements for work on chemical research and development
(costs in 1000 dollars)

	Fiscal year											
	1975	1976	1977	1978	1979	1980	1981	1982	1983	1984	1985	1986
4.1 Fuel salt chemistry	15	65	85	37	27	15	57	77	77	22		
4.2 Coolant salt chemistry	25	45	110	90	52	22	75	145	40			
4.3 Tritium behavior	16	22	18	16	45	157	82	35	25	19	4	
4.4 Fission product chemistry		20	30	45	5	120	37	10	2			
4.5 Fundamental studies of molten salts	16	5	30	50	10							
Total capital equipment funds for chemical research and development	72	157	273	238	139	314	251	267	144	41	4	

- (5) Radiation within the primary heat exchanger should have minimal detrimental effects upon the vapor pressure, composition and compatibility of the coolant.
- (6) The coolant should have acceptable heat-transfer and fluid properties. Film coefficients should be high; viscosity and density should be low.
- (7) The coolant should have a freezing point below 600°F. Any freezing point below 600°F (316°C) would permit feedwater temperatures (550-580°F) used in conventional supercritical steam cycles. Higher coolant freezing points, perhaps as high as 775°F, can be tolerated if the feedwater is preheated with steam diverted from the steam generators.⁴
- (8) The coolant should exhibit a low vapor pressure at normal operating temperatures. If a significant vapor pressure (>0.01 atm) must be tolerated, the vapor should have a low condensation temperature.
- (9) The coolant should be inexpensive and available in high purity. Elements rare in the earth's crust should not be considered for a future multireactor MSBR system.

Only a few materials meet these requirements and constraints. The present design composition is a mixture of 92 mole % NaBF₄ (sodium fluoroborate) and 8 mole % NaF. The fluoroborate coolant does not completely satisfy all of the above criteria, although its shortcomings can be accommodated by design adjustments. Alternate coolants are also being considered (Sect. 5.5.8, Task 4.2.4). Since some uncertainty exists as to the ultimate choice of coolant, the coolant salt research and development activities are not as firmly defined as those for the fuel salt.

5.3.2 Background

5.3.2.1 Experience with molten salt fuels

Molten salt systems for high-temperature nuclear reactors have been under development since 1947 and extensive experience with fluoride-based salts has been accumulated.⁵ First developed were NaF-ZrF₄-UF₄ mixtures, which fueled the Aircraft Reactor Experiment in 1954. As breeder reactor development received increasing emphasis, a fuel composed of ⁷LiF-BeF₂-ZrF₄-UF₄ was developed and used in the Molten-Salt Reactor Experiment (MSRE) which operated for a total of 2-1/2 years beginning in 1966 until the scheduled shut down. Extensive experience with fluoride-based molten salts was accumulated during this period.⁶ Thus, the present fuel salt selected for MSBRs is based on a long, well-established background of experience and appears most likely to meet the requirements of MSBRs with a minimum of additional research and development.

5.3.2.2 Experience with coolant salt

Previous work with coolant salts has been much more limited than that with fuel salts. The MSRE was designed as an evaluation of the fuel, reactor vessel, and reactor operating characteristics. The coolant for the MSRE, a LiF-BeF₂ mixture, was used to reject heat to an air radiator. Its melting point of 851°F is higher than acceptable for use in a conventional steam-raising system.

The use of sodium fluoroborate as a coolant was first suggested in 1966 and experience has been accumulated since then. Investigations of the phase behavior of the binary system identified the eutectic mixture as NaBF₄-NaF (92-8 mole %) with a melting point of 384°C; this mixture was tentatively selected as the reference coolant for an MSBR. Considerable additional research is needed, however, to assure that this will be a satisfactory coolant. In particular, the ability of NaBF₄ to trap tritium by exchange with OH⁻ species in the melt remains undemonstrated and alternate MSBR designs may be considered.⁷ The NaBF₄-NaF mixture is more corrosive toward Hastelloy N than is the fuel salt and additional knowledge of corrosion reactions is needed. Interactions with fuel salt and with steam, which could result from leaks, need to be more fully considered, and additional measurements of physical properties are needed.

Although fluoroborate can possibly be used as the coolant salt for MSBRs, there is incentive to consider alternate coolant materials. An evaluation of alternate coolants will receive an early priority in addition to research and development on fluoroborate. Resolution of the coolant salt selection must be made early in order that reactor design and engineering development can proceed smoothly.

5.3.3 Status of development

5.3.3.1 Fuel salt chemistry

Phase equilibria among the pertinent MSBR fluorides largely have been studied in detail, and the equilibrium diagrams are relatively well understood. Diagrams for binary systems such as LiF-BeF₂, LiF-UF₄, and LiF-ThF₄ have been developed;^{8,9} similarly, those for ternary systems such as LiF-BeF₂-ThF₄ and LiF-BeF₂-UF₄ have been established.^{8,10}

The requirement that oxide ion either be absent or be present only in very low concentrations in the molten fluoride fuel was recognized in the early stages of development of molten-salt reactors.¹¹ In the MSRE, ZrF₄ served as an oxide "getter", thus preventing the possible formation and precipitation of the sparingly soluble UO₂.¹² The experience gained with the operation of the MSRE indicated that no increase in oxide concentration had occurred during the lifetime of the reactor, and demonstrated the feasibility of performing the necessary reactor operations and maintenance without significant atmospheric contamination. Since the MSBR fuel solvent will not contain ZrF₄, more stringent restrictions

on the presence of oxide are required. If accidental contamination of MSBR fuel with significant amounts of air or water should occur, then not only could UO_2 precipitate but also ThO_2 , PaO_2 , PuO_2 and NpO_2 . It has been established that the actinide dioxides all have the same fluorite type structure; consequently, the presence of two or more actinides is conducive to the formation of insoluble oxide solid solutions.¹³⁻¹⁶ The data obtained indicated that the distribution of heavier actinides between the liquid and solid phases strongly favors the latter. A correlation was found between the measured distribution quotients and the lattice parameters of the pure actinide oxides which allowed prediction of the precipitation behavior of neptunium¹⁶ and the distribution of actinides between the melt and binary and ternary solid solutions.¹⁷

The important effect of the redox potential of the fuel on the corrosion of structural materials in a molten-salt reactor has also been recognized.¹⁸ From an overall standpoint, the fission process is slightly oxidizing; this effect was mitigated in the MSRE by using a redox buffer established by maintaining a small fraction of the uranium present as UF_3 . The UF_3/UF_4 ratio thus established the redox potential of the fuel salt. All of the actinides present in significant quantities in an MSBR, with the exception of thorium, exhibit a multivalent character; thus, the redox potential of the fuel will determine the oxidation state of these elements and, consequently, the valence of the actinides in a precipitated oxide phase. It has been determined that the solubility behavior of the protactinium oxides Pa_2O_5 and PaO_2 is quite different. The former appears as a single phase and has a much lower solubility than PaO_2 , which appears in binary or tertiary solid solutions.^{19,20} Similarly, it has been demonstrated that plutonium will precipitate only as a dioxide in solid solution while trivalent plutonium does not appear to precipitate at all as an oxide from the fuel salt.¹⁵

From the standpoint of reactor safety, it is very important to evaluate accurately the solubility behavior of the various actinide oxides and their interactions as a function of temperature and as a function of redox potential. Some actinide oxide-fluoride systems have been well characterized with regard to their dependence on temperature and redox potential while others are less well defined; thus, the research required on this subject (discussed in detail later) has various degrees of priority.

After shutdown of the MSRE, it was found that some intergranular attack had occurred in Hastelloy N samples and reactor components.²¹ Although the attack was not catastrophic, it appeared to be significant when the specimens were subjected to stress. Analyses of the specimens indicated the presence of fission products, especially tellurium. Preliminary scanning tests made in the laboratory with several of these elements suggested strongly that tellurium was responsible for the intergranular attack.²¹ Little is known about the behavior of tellurium in an MSR environment, especially about the effect of the redox potential of the fuel on the relative concentrations of the various tellurium species

Te_2^0 , Te^{2-} , etc., which may be present.²² It is necessary to study this effect in order to develop methods for dealing with the presence of tellurium.

Plutonium (as PuF_3) has been proposed as a component of the start-up fuel for MSBRs²³ or as the make-up fuel in molten-salt converter reactors; it has already been used as fissionable make-up fuel, replacing the consumed ^{233}U in the MSRE.⁵ In order to start up a molten-salt reactor with plutonium and run it successfully, the behavior of this element under normal operating conditions and in the presence of impurities such as O^{2-} has to be known. The solubility of PuF_3 in molten fluorides must be adequate to satisfy the requirements of converter or breeder reactors. Some solubility measurements in $\text{LiF}-\text{BeF}_2-\text{ThF}_4$ solutions were made at ORNL²⁴ and at Bhabha Atomic Research Centre, India.²⁵ Although there is a discrepancy between the values obtained by the laboratories, the results obtained indicate that even the lower measured solubilities (India) amply satisfy the requirements for an MSBR. Nevertheless, it is necessary to determine the cause of the difference in the values. The effect of oxide on the solubility of PuF_3 under different redox conditions has been studied to some extent at ORNL,^{15,24} but more research will be required in order to completely define the system and to obtain useful thermochemical data for the various plutonium species.

One of the safety aspects of the MSBR that requires scrutiny is the behavior of actinides in the event of accidental mixing of fuel salt and the reference coolant, NaBF_4-NaF (92-8 mole %). It is known from preliminary experiments²⁶ that both phases exhibit partial miscibility under some, although not well defined, conditions. The BF_3 gas pressures thus generated under static or dynamic mixing conditions are not well known for the former condition, and are unknown for dynamic mixing. Although it may be speculated that, in the event of mixing, the actinides may separate as the triple fluoride salt $7\text{NaF}\cdot 6(\text{Th},\text{U})\text{F}_4$ identified to have formed in a large loop,²⁷ the conditions under which separation can occur (such as ratio of volumes of fuel to coolant salt, velocity of mixing, and temperature) have not been defined.

Although physical properties of fluoride mixtures are, in general quite well known,^{28,29} those of the MSBR fuel salt in particular will require more precise measurements, especially its thermal conductivity. The vapor pressure, the predominant species in the vapor phase above the residual fuel salt after vaporization of a specified fraction of the initial liquid, and the latent heat of vaporization of the corresponding liquid will have to be determined since no direct measurements are currently available; the present estimates were obtained by extrapolation from measurements with the systems $\text{LiF}-\text{BeF}_2$ and $\text{LiF}-\text{UF}_4$.

A UF_3/UF_4 ratio will have to be selected for the MSBR which satisfies or reaches a compromise among the numerous equilibria occurring simultaneously in the reactor; e.g. the depletion of chromium from the surface of the Hastelloy N, the oxidation-reduction of tellurium species and of protactinium 4+ and 5+ species, the reaction of UF_3 with graphite leading

to the formation of uranium carbides, etc. The latter equilibrium has been studied,³⁰ and the results indicated that fuel salt with a UF_4/UF_3 ratio larger than 10 is stable at 550°C with respect to the formation of the uranium carbide UC_2 . In the event of atmospheric contamination, not only does the UF_3/UF_4 ratio decrease but the concentration of O^{2-} increases. Evidence has been found recently which suggests that the presence of oxide may lead to the formation of solid uranium oxycarbides, more stable than the binary carbide.³⁰ Since no other data on the subject are available, this aspect of the effect of oxide and redox potential will be examined further.

5.3.3.2 Coolant salt chemistry

In an MSBR it is not possible to couple the circulating fuel directly to the steam-generating system. Two reasons may be cited: first, the melting point of the fuel salt is considerably higher than the feedwater temperatures desired for the steam system; second, leaks would have undesirable economic and potentially hazardous consequences; e.g., steam leaking into the fuel salt would precipitate uranium, thorium, and beryllium as oxides and fuel leaking into the steam system would contaminate the latter with fission products, tritium, and other radioactive substances (Pa, U, Th). Thus, an MSBR requires a coolant system to act as a protective barrier between the fuel circuit and the steam-generating system and to transport the heat to the steam-raising system without freezing either fuel salt or coolant.

Coolants being considered for other advanced reactors are less desirable as coolants for molten-salt reactors. Sodium (as well as other alkali metals) reacts vigorously with fuel salt and with steam. High-pressure helium would require that the primary heat-exchanger system be very large, thereby increasing the fuel inventory and the doubling time of the reactor.

In the MSRE, the coolant was ${}^7LiF - BeF_2$ (66-34 mole %). This coolant discharged its heat at 546°C (1015°F) to an air-cooled radiator which was maintained above the coolant's freezing point, 459°C. The MSRE coolant composition is not suitable for use in an MSBR since the freezing point is too high for transmitting heat to a system in which the feedwater is supplied at or below 371°C (700°F). In addition, there would be a practical necessity for using isotopically pure (and expensive) lithium-7 in the coolant salt. If lithium in natural isotopic abundance were used, leakage of coolant into the fuel circuit would require expensive procedures for removing lithium-6 or acceptance of decreased breeding performance and increased tritium production.

There are two important requirements for an MSBR coolant. One, which is unique and stringent, is that the effects of leakage in the primary heat exchanger must be minimal and reversible. It is also highly desirable that all the tritium that diffuses into the coolant circuit be sequestered in this circuit. The first requirement dictates that chemical reactions between the fuel salt and the coolant must not lead to precipitation

of uranium (and other elements) from the fuel; neither should violent (i.e., strongly exothermic) reactions occur upon mixing of the fuel salt and coolant. In meeting the second requirement, about 800 curies of tritium per day³¹ would have to undergo oxidation, isotope-exchange or some other interaction which interdicts the flow of tritium into the steam system.

A molten mixture of NaBF_4 and NaF provisionally appears to meet the necessary heat-transfer requirements for an MSBR coolant. It is relatively inexpensive and, at normal operating temperatures (454 - 621°C), exhibits acceptable thermal capacity,²⁸ thermal conductivity,³² and favorable viscosity and density.²⁹ The vapor pressure of BF_3 , due to thermal decomposition of this coolant, was found to be less than 1 atm at the highest operating temperature for compositions containing less than 93 mole % NaBF_4 . Accurate studies of phase behavior²⁸ showed that the composition NaBF_4 - NaF (92-8 mole %) had the lowest-melting point, 384°C, in the system.

Fluoroborate coolant contains protonic and oxide impurities which persist at some low level despite attempts to eliminate them by chemical purification. Oxide solubility is high in fluoroborate, indicating that strong boron-oxygen bonds exist, and these effectively resist chemical means of replacing the oxygen with fluorine. The protonic impurities are partly bound³³ in the anion, BF_3OH^- . However, attempts to exchange deuterium with the hydrogen in this anion have thus far been unsuccessful.³³ Oxidizing ions (Ni^{2+} , Fe^{2+} , Cr^{3+}), soluble in low concentration,^{34,35} may possibly be used in schemes for sequestering the tritium within the coolant circuit.

The corrosivity of fluoroborate to Hastelloy N under normal reactor operating conditions seems to be acceptably low, although delayed neutron interaction with a small amount of boron, chemically reduced from the coolant, could conceivably cause embrittlement of heat-exchanger tubes if the diffusivity of the resulting borides in Hastelloy N is sufficiently high. Steam greatly increases the corrosivity of fluoroborate; much additional study of the corrosive effects of steam is necessary before the consequences of steam leakage into this coolant can be reliably predicted.

The consequences of mixing fuel salt and fluoroborate have not been extensively examined. Measurements of BF_3 solubility³⁶ suggest that even gross mixing of coolant with fuel salt will not cause dangerously high BF_3 pressures provided equilibrium is reached; a real mixing situation can conceivably result in more detrimental consequences. Leakage of fuel salt into coolant could pose important safety questions about the precipitation of constituents from the fuel.

A study is underway to assess the attributes of other materials relative to fluoroborate as a coolant. Until these other potential coolants are adequately examined, it is prudent to continue investigating the relevant chemistry of fluoroborate since NaBF_4 - NaF may yet be the best overall choice for an MSBR coolant.

5.3.3.3 Tritium behavior

About 0.25 g of tritium is generated per day in a 1000-MW(e) molten-salt reactor.³⁷ Since metals at high temperatures are permeable to the isotopes of hydrogen, the pathways for tritium flow from the reactor to the environment are numerous. Although many of the pathways do not present serious difficulty, the flow to the steam generator results in tritium contamination of the steam system and release of tritium to the environment via blowdown and leakage to the condenser coolant.

Calculations indicate that, in the reference MSBR, about 790 Ci/day of tritium might reach the steam system.³⁷ Virtually all of this would be released by normal system blowdown into the condenser cooling water. Discharge of 790 Ci/day in a 560,000 gal/min stream³¹ produces a concentration of $260 \times 10^{-3} \mu\text{Ci/liter}$. This is 52 times the $5 \times 10^{-3} \mu\text{Ci/liter}$ concentration used as a design objective for liquid effluents for light-water-cooled nuclear power reactors.³⁸ Molten-salt reactors may possibly be required to attain similarly low concentrations, so the unhindered discharge of tritium in liquid effluents from the reference-design MSBR appears to be unacceptable.³⁷

In addition to the loss of tritium to the environment, contamination of the steam system could reach levels of 4-9 mCi/cc in the 300,000-gal inventory of water in a typical plant.³⁷ This concentration is about the same as in the moderator of a large heavy water reactor,³⁹ and extensive safety precautions would be required to permit maintenance of the MSBR steam system.

Tritium transport to the steam system might be prevented if a combination of techniques can be used to contain and to process the tritium in a MSBR. Containment might be achieved if, for example, an oxide corrosion film formed by steam on steam generator tubing serves to impede tritium permeation. Some varieties of corrosion films on candidate steam generator materials have been found to offer significant impedance to permeation.⁴⁰ The extension of this work to the conditions expected in a steam generator will require experimental development.

Both the chemical form and the transport properties of tritium are significant for consideration of tritium management in MSBR systems. Solubilities and diffusivities of tritium-containing species in fuel and coolant are needed for the development of adequate representations of tritium behavior in MSBRs and for evaluation of potential methods for tritium processing. Some measurements of hydrogen and deuterium solubilities in fluoride salts have been made.⁴¹ The reaction of hydrogen with uranium (IV) fluoride to produce UF_3 and hydrogen fluoride has been studied,⁴² as has the adsorption of hydrogen on graphite.⁴³ The chemical reactions of hydrogen with candidate coolants have also received attention. It is possible that a chemical processing method for removal of tritium from the coolant may be developed. Such development would require additional research and would not obviate the need for an increased resistance to tritium permeation which may be afforded by a corrosion film in the steam generator.

5.3.3.4 Fission product chemistry

Because of the effect of fission products on reactor operation and performance with regard to breeding, materials behavior, afterheat and maintenance, much attention has been given to understanding their fate in the MSRE and more will necessarily be required in future MSBR development. The fission products fall into several groups according to their chemical behavior in molten fluorides. These groups, in order of importance as neutron poisons, are: the noble gases, the stable salt-seeking rare-earth fluorides, the noble metals, and the other stable salt-seeking fluorides. Table 5.3.3.4 shows the distribution of fission products found in the MSRE.

The noble gases have very low solubilities in the fuel salt^{41,42-46} and, consequently, can be removed by sparging with helium. This was effectively demonstrated in the MSRE where over 80% of the ¹³⁵Xe was removed.⁴⁷ More efficient methods of sparging have been proposed for the MSBR and, consequently, noble gas poisoning is expected to be held at a minimum. Since most of the ¹³⁵Xe is produced indirectly by decay of the 6.7-hr half-life ¹³⁵I, the usage of sidestream iodine strippers has been suggested⁷⁶ as a method of minimizing poisoning in an MSBR. This would involve the reaction: $\text{HF(g)} + \text{I}^- \rightarrow \text{F}^- + \text{HI(g)}$, where HF(g) is added in small amounts to the normal helium sparge. If the other methods for holding the ¹³⁵Xe poison fraction⁴⁸ at acceptable levels do not prove successful, it has been proposed that the iodine stripping system might be used in conjunction with the Xe removal process.

The rare earths and other stable soluble fluorides (e.g., Zr, Ce, Nd, Sr, Cs, Y, Ba, Rb) are all expected to be found principally in the fuel salt and can be removed by processing schemes currently under development (see Section 3). The chemical behavior of the above fission products is fairly well understood and, like the noble gas behavior, can be anticipated in operating molten-salt reactors.

The chemical behavior of the so-called noble-metal fission products (Nb, Mo, Tc, Ru, Ag, Sb, and Te) is considerably less predictable — as has been borne out in MSRE operations — and warrants further study. These fission products appear throughout the fuel system: in the salt, metal, graphite and, possibly, the cover gas (Table 1). Based on available thermodynamic data, they are expected to appear in a reduced form at UF₄/UF₃ ratios less than 10². However, in the reduced and presumed metallic state, these fission products can disperse via many mechanisms.

MSRE operation analyses of five noble-metal nuclides, ⁹⁹Mo, ¹⁰³Ru, ¹⁰⁶Ru, ¹²⁹⁻¹³²Te, found in salt samples ranged from fractions to tens of percent of inventory. Based on thermodynamic considerations and a correlation of their behavior with that of ¹¹¹Ag for which no stable fluoride exists under fuel salt conditions, it has tentatively been concluded that they are also metallic species which occur as finely divided particles suspended in the salt.

Table 5.3.3.4. Indicated distribution of fission products in molten salt reactors

Fission product group	Example isotopes	Distribution (%)				
		In salt	To metal	To graphite	To off-gas	Other
Stable salt seekers	^{95}Zr , ^{144}Ce , ^{147}Nd	~99	Negligible	<1 (fission recoils)	Negligible	Processing ^a
Stable salt seekers (noble gas precursors)	^{89}Sr , ^{137}Cs , ^{140}Ba , ^{91}Y	Variable/ $T_{1/2}$ of gas	Negligible	Low	Variable/ $T_{1/2}$ of gas	
Noble gases	^{89}Kr , ^{91}Kr , ^{135}Xe , ^{137}Xe	Low/ $T_{1/2}$ of gas	Negligible	Low	High/ $T_{1/2}$ of gas	
Noble metals	^{95}Nb , ^{99}Mo , ^{106}Ru , ^{111}Ag , ^{129}Te	1-20	5-30	5-30	Negligible	Processing ^b
Iodine	^{131}I , ^{135}I	50-75	<1	<1	Negligible	Processing ^c

^a For example, Zr tends to accumulate with Pa holdup in reductive extraction processing.

^b Particulate observations suggest appreciable percentages will appear in processing streams.

^c Substantial iodine could be removed if side-stream stripping is used to remove ^{135}I [77].

The noble-metal fission products were also found deposited on graphite and Hastelloy N specimens (i.e., surveillance as well as post-operation specimens). However, their distribution on both sets of specimens varied widely and allowed for only very tenuous conclusions to be drawn. It was evident from these studies that net deposition was generally more intense on the metal than on graphite, and for the metal was more intense under turbulent flow.

Gas samples taken from the pump bowl during ^{235}U operation of the MSRE indicated that substantial concentrations of noble metals were present in the gas phase, but improved sampling techniques incorporated during the ^{233}U operation of the MSRE failed to corroborate these observations. Present interpretations of these conflicting data suggest that the earlier ^{235}U -operation samples were contaminated by salt mist, and that only a small fraction of the noble metal fission products escape to the cover gas.

Niobium is the most susceptible of the noble metals to oxidation and was found appreciably in salt samples at the start of the ^{233}U MSRE operation because of the high initial $\text{U}^{4+}/\text{U}^{3+}$ ratio. It could be made to disappear by lowering the redox potential of the fuel,¹ but subsequently reappeared in the salt several times for not always explainable reasons. The ^{95}Nb data did not correlate with the Mo-Ru-Te data mentioned previously nor was there any observable correlation of its behavior with amounts found in gas samples.¹

The actual state of these noble metal fission products is of importance to the effectiveness of MSBR operations. If they exist as metals and plate the Hastelloy N portions of the reactor, they will be of little consequence as poisons although they can be of importance in determining the level of fission product afterheat after reactor shutdown and will complicate maintenance operations and post-operation decontamination. (The effect of Te on structural metal integrity is also realized here but is treated in Section 5.4.6). They can potentially cause difficulty by carbide formation or by adhering in some other way to the graphite moderator; however, examination of the MSRE graphite moderator indicated that the extent of such deposition was limited.

Clearly, most of the future fission product chemical research should be directed at increasing our understanding of noble-metal fission product behavior to a level comparable to that of the other fission products. The major objective should be to determine the controlling mechanisms and associated reaction rates for noble metal interactions with various portions of an MSBR in order that extrapolation to larger and more complex systems can follow. Among factors of importance to future reactors are the redox potential of the system (characterized by the $\text{U}^{4+}/\text{U}^{3+}$ ratio), the presence of oxide and its affinity for various fission products, the possible agglomeration of metals onto gas and bubble interfaces in the absence of colloidal (metallic, graphite, oxide, etc.) particles, the deposition of noble metals onto colloidal particles, and the deposition and resuspension of particles bearing noble metals. The exploitation of suitable mechanisms to remove noble

metal fission products or to control their deposition could be an attractive result of such studies. Finally, future work should take into account handling of the noble metals or structural components contaminated by them.

5.3.3.5 Fundamental studies of molten salts

A fairly comprehensive knowledge of the formation free energies (ΔG^f) of solutes in molten Li_2BeF_4 has been gained over the years from measurements of heterogeneous equilibria involving various gases (e.g., HF or H_2O) and solids (e.g., metals or oxides).⁴⁹⁻⁵⁴ The list of dissolved components for which formation free energies have been estimated includes LiF , BeF_2 , ThF_4 , several rare-earth trifluorides, ZrF_4 , UF_3 , UF_4 , PaF_4 , PaF_5 , PuF_3 , CrF_2 , FeF_2 , NiF_2 , NbF_4 , NbF_5 , MoF_3 , HF, BeO, BeS, $\text{Be}(\text{OH})_2$, and BeI_2 . Some of these ΔG^f values, however, are presently insufficiently accurate for the needs of the MSBR program (e.g., those for PaF_4 , PaF_5 , ThF_4 , MoF_3 , NbF_4 , NbF_5 , BeS) and additional equilibrium measurements involving these solutes are needed. Moreover, there is a need for the ΔG^f values of certain other fission product compounds such as the lower fluorides of Tc and Ru, and various dissolved compounds of Te. A more urgent need is an increased knowledge of how activity coefficients (which have been defined^{50,51} as unity in Li_2BeF_4) vary as the melt composition changes. Such knowledge is required to predict how the numerous chemical equilibrium constants that may be derived from ΔG^f values in Li_2BeF_4 will change as the melt composition is changed to that of an MSBR fuel. It is clear from what is known that the variation of activity coefficients with melt composition depends primarily on the mole fraction of LiF and the size and the charge of the cation involved. Enough additional data reflecting the variation of activity coefficients with melt composition is needed to make this correlation sufficiently quantitative to meet the needs of the MSBR program.

Porous or packed-bed electrodes have been demonstrated to have excellent capability for removal or measurement of species at low concentration in aqueous media.^{55,56} Application of suitable impressed electrochemical potentials to such electrodes results in quantitative deposition of the species of interest. Preliminary considerations suggest the successful development of techniques for utilizing similar electrodes in fused salts of interest to molten-salt breeder reactors. Successful development of such techniques could lead to analytical and process applications for detecting and/or removing various chemical species such as oxide, tellurium, or bismuth at the parts per million level.

5.4 TASK GROUP 4.1 FUEL SALT CHEMISTRY

5.4.1 Objective

Most of the chemical properties of the components of fuel salts have been established either in the pure state or in mixtures. However, due to the complex nature of the fuel salt in the reactor environment

some aspects need further research to determine the variables which will allow the reactor to operate under optimum conditions. The studies covered in this task group, with the exception of the determination of some physical properties, lean heavily toward safety aspects of the reactor, ranging from normal operating conditions to accidental contamination with the atmosphere and accidental mixing of fuel and coolant. These objectives are discussed below as tasks and subtasks and are itemized in the schedule (Section 5.4.2).

5.4.2 Schedule

The schedule for this task group is shown in Table 5.4.2.

5.4.3 Funding

Anticipated funding requirements are shown in Tables 5.4.3.1 and 5.4.3.2 for operating and capital funds, respectively.

5.4.4 Facilities

The research in this task group can be carried out in existing chemical laboratories in Building 4500S and the High-Level Alpha Laboratory in Building 4501. No additional special facilities will be needed.

5.4.5 Task 4.1.1 Solubility products of actinide oxides

The presence of oxide ion in fuel salt above some level has a deleterious effect because it acts as a precipitating agent for the actinide ions. Because several actinides will be simultaneously present in the fuel salt, it is desirable to have accurate measurements of the solubility products of the pure oxides over the range of redox potential values of interest for molten salt reactors. This, in turn, will allow calculation of the solubility and composition of mixed oxides in solid solution. Although thorium oxide exhibits the highest solubility among the actinide dioxides, thorium is by far the most abundant actinide present in the reactor and, thus, its oxide can lower the activity (by solid solution formation) of other actinide oxides.

Additional studies are required on the solubilities of oxides of thorium, protactinium, plutonium and neptunium in fuel salt. It is not believed that data are required for oxides of higher atomic number than plutonium since those elements will be present at very low concentrations.

5.4.5.1 Subtask 4.1.1.1 Thorium oxide

The solubility product of ThO_2 in molten mixtures of $\text{LiF-BeF}_2\text{-ThF}_4$ has been determined indirectly from equilibration studies with other actinide

Table 5.4.2. Schedule for work in Task Group 4.1 - Fuel salt chemistry

	Fiscal year											
	1975	1976	1977	1978	1979	1980	1981	1982	1983	1984	1985	1986
4.1.1 Solubility products of actinide oxides												
4.1.1.1 Thorium oxide												
4.1.1.2 Protactinium oxides												
4.1.1.3 Plutonium oxides												
4.1.1.4 Neptunium oxides												
4.1.2 Tellurium chemistry												
4.1.2.1 Solubility of tellurium and tellurides in molten solvent salts												
4.1.2.2 Behavior of Te_3^{1-} in the presence of metals of construction												
4.1.2.3 Oxidation-reduction chemistry of tellurium in fuel salt containing uranium												
4.1.2.4 Preparation of metallurgical samples												
4.1.3 Phase behavior of PuF_3 in fuel salt												
4.1.4 Fuel-coolant interaction studies												
4.1.4.1 Phase equilibria												
4.1.4.2 Dynamic investigations												

Table 5.4.2 (continued)

	Fiscal year											
	1975	1976	1977	1978	1979	1980	1981	1982	1983	1984	1985	1986
4.1.5 Physical property determinations on fuel salt												
4.1.5.1 Thermal conductivity												
4.1.5.2 Surface properties												
4.1.5.3 Vapor pressure, composition, and heat of vaporization												
4.1.6 U ³⁺ /U ⁴⁺ equilibria studies												

Table 5.4.3.1. Operating fund requirements of Task Group 4.1 - Fuel salt chemistry
(costs in 1000 dollars)

	Fiscal year												
	1975	1976	1977	1978	1979	1980	1981	1982	1983	1984	1985	1986	
4.1.1 Solubility products of actinide oxides													
4.1.1.1 Thorium oxide									55	55	55		
4.1.1.2 Protactinium oxides				25	55	55							
4.1.1.3 Plutonium oxides							55	55	55				
4.1.1.4 Neptunium oxides						25	55	55					
Subtotal 4.1.1				25	55	80	110	110	110	55	55		
4.1.2 Tellurium chemistry													
4.1.2.1 Solubility of tellurium and tellurides in molten solvent salts	40	40	40										
4.1.2.2 Behavior of Te_3^{1-} in the presence of metals of construction		20	36	20									
4.1.2.3 Oxidation-reduction chemistry of tellurium in fuel salt containing uranium				30	55	70	110	55					
4.1.2.4 Preparation of metallurgical samples	25	15	15	15	15	15	15	15					
Subtotal 4.1.2	65	75	91	65	70	85	125	70					
4.1.3 Phase behavior of PuF_3 in fuel salt									15	25			

Table 5.4.3.1 (continued)

	Fiscal year											
	1975	1976	1977	1978	1979	1980	1981	1982	1983	1984	1985	1986
4.1.4 Fuel-coolant interaction studies												
4.1.4.1 Phase equilibria	48	40										
4.1.4.2 Dynamic investigations		30	20	20								
Subtotal 4.1.4	48	70	20	20								
4.1.5 Physical property determinations on fuel salt												
4.1.5.1 Thermal conductivity							55	55				
4.1.5.2 Surface properties								55	55			
4.1.5.3 Vapor pressure, composition, and heat of vaporization									55	55	55	
Subtotal 4.1.5							55	110	110	55	55	
4.1.6 U ³⁺ /U ⁴⁺ equilibria studies	55	55	55	55	95	55	55	25				
Total operating fund requirements for Task Group 4.1	168	200	166	165	220	220	345	330	245	110	110	

Table 5.4.3.2. Capital equipment fund requirements for Task Group 4.1 - Fuel salt chemistry
(costs in 1000 dollars)

	Fiscal year											
	1975	1976	1977	1978	1979	1980	1981	1982	1983	1984	1985	
4.1.1 Solubility products of actinide oxides												
4.1.1.1 Thorium oxide									5	2		
4.1.1.2 Protactinium oxides				10	2							
4.1.1.3 Plutonium oxides							10	5	2			
4.1.1.4 Neptunium oxides						10	5	2				
Subtotal 4.1.1				10	2	10	15	7	7	2		
4.1.2 Tellurium chemistry												
4.1.2.1 Solubility of tellurium and tellurium in molten solvent salts	5	32	25									
4.1.2.2 Behavior of Te_3^{1-} in the presence of metals of construction		10	10									
4.1.2.3 Oxidation-reduction chemistry of tellurium in fuel salt containing uranium				25	25	5	2					
4.1.2.4 Preparation of metallurgical samples		5										
Subtotal 4.1.2	5	47	35	25	25	5	2					
4.1.3 Phase behavior of PuF_3 in fuel salt									10	5		

Table 5.4.3.2 (continued)

	Fiscal year											
	1975	1976	1977	1978	1979	1980	1981	1982	1983	1984	1985	
4.1.4 Fuel-coolant interaction studies												
4.1.4.1 Phase equilibria	5	5										
4.1.4.2 Dynamic investigations	—	10	40									
Subtotal 4.1.4	5	15	40									
4.1.5 Physical property determinations on fuel salt												
4.1.5.1 Thermal conductivity							40	10				
4.1.5.2 Surface properties								50	5			
4.1.5.3 Vapor pressure and composition										60	20	
Subtotal 4.1.5							40	60	65	20		
4.1.6 U ³⁺ /U ⁴⁺ equilibria studies	5	3	10	2								
Total capital equipment funds for Task Group 4.1	15	65	85	37	27	15	57	77	77	22		

oxides, PaO_2 and Pa_2O_5 .^{16,19} Attempts to directly measure the concentration of oxide ion in ThO_2 -saturated melts by chemical analysis yielded less precise values⁵⁷ and EMF measurements using a LaF_3 electrode⁵⁸ were unsuccessful.⁵⁹ At 550°C the solubility product of ThO_2 calculated from the available data^{10,19,57} is respectively 6.9×10^{-8} , 14.8×10^{-8} and 10.7×10^{-8} . Although these values disagree at most by a factor of 2, they are presently quite useful for estimating the behavior of Th^{4+} in the presence of O^{2-} and do not jeopardize reactor safety calculations because ThO_2 is the most soluble of the actinide dioxides that could form in an MSBR. Future research, however, should involve a reexamination of this parameter, although not as a high priority topic. Unless an oxide-sensitive electrode is developed for use in molten fluorides, the solubility studies will be performed by equilibration of the oxide-melt system, and subsequent sampling, grinding etc. in a moisture-free inert atmosphere glove box. An alternative determination can be performed by means of the metathesis reaction:

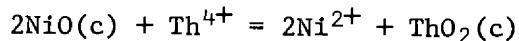

in which the filtered samples will be analyzed for dissolved nickel.

5.4.5.2 Subtask 4.1.1.2 Protactinium oxides

Protactinium can be precipitated from molten fluorides as Pa_2O_5 or as binary or ternary solid solutions of PaO_2 , depending on the redox potential of the system and the other actinides present. The solubility of Pa_2O_5 was determined directly in molten fluorides saturated with ThO_2 ¹⁹ and from measurements of the equilibrium²⁰

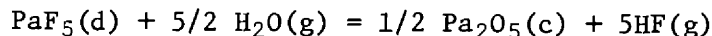

together with measurements of the equilibrium⁶⁰

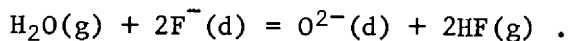

Assuming that all the protactinium in the reactor is pentavalent imposes a minimum limit on the concentration of allowable O^{2-} . If the Pa^{5+} concentration in the reactor⁶¹ is 1.972×10^{-6} mole/cm³, the oxide concentration allowed at 550°C is, respectively, less than 8.6×10^{-5} (ref. 19) and 1.23×10^{-5} (ref. 20). The disagreement in these values is tolerable at 550°C but increases with increasing temperature because the temperature effect on the solubility of Pa_2O_5 is more pronounced in the values obtained from ref. 19. Due to this large temperature effect, it was suggested¹⁹ that the precipitate may have been solvated with LiF . In a long range plan, this discrepancy of the temperature dependence and identity of the precipitate will have to be resolved because Pa_2O_5 also participates in other reactions of relevance to the chemistry of the MSBR, such as

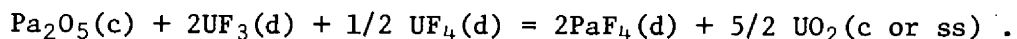

This reaction is important because it indicates the effect of redox potential on the predominant species of protactinium in the melt. From a safety point of view, these data can be used to estimate the minimum ratio of UF_3/UF_4 that should be used to keep the protactinium tetravalent, in which case the corresponding oxide exhibits a higher solubility than Pa_2O_5 .

Although measurements have been made¹⁹ to determine the effect of redox potential by means of the equilibrium

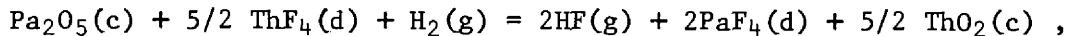

the data showed considerable uncertainty. The redox potential of the couple PaF_5/PaF_4 will be determined with higher precision by means of electroanalytical and spectrophotometric methods or by a transpiration technique.²⁰ The electroanalytical method will determine the redox potential by voltammetry in a system where the value of the ratio is changed by means of sparging with $HF-H_2$ mixtures, i.e.

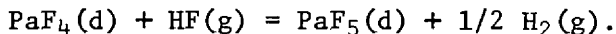

The spectrophotometric method will use the difference in absorptivity of both protactinium species⁶² to determine their ratio and the transpiration technique will be a repetition of earlier measurements²⁰ but with significantly larger amounts of protactinium. Independent experimental work will be performed with appreciable amounts of protactinium, in the order of several grams, in order to provide unequivocal identification of the equilibrium solid phases present in the system.

5.4.5.3 Subtask 4.1.1.3 Plutonium oxides

The oxide chemistry of plutonium was studied in several molten fluoride melts.^{15,24} It was found that the addition of oxide to PuF_3 -containing melts did not precipitate any plutonium oxide under mild reducing conditions, independent of the composition of the melt; i.e., $LiF-BeF_2$ containing ZrF_4 or ThF_4 or the pure solvent $LiF-BeF_2$. When PuO_2 was added to a $LiF-BeF_2$ melt contained in nickel, all of the plutonium ended up as PuF_3 in solution. Spectrophotometric measurements in molten $LiF-BeF_2-ThF_4$ did not reveal the presence of any plutonium oxyfluoride²⁴ although such a compound has been reported to exist in the solid state. However, when the oxidation state of the system was increased, e.g., by the addition of NiF_2 , it was found that, in the presence of thorium, the addition of oxide yielded a solid solution of PuO_2-ThO_2 .¹⁵ The correlation found between distribution quotients and lattice parameters of pure actinide oxides¹⁶ led to the prediction of a large distribution coefficient for Pu^{4+} ($>10^4$); i.e., it is possible to obtain PuO_2-ThO_2 solid solutions with virtually pure PuO_2 . Because the measured distribution quotient of plutonium corresponds to Pu^{4+} , the determination of a large distribution quotient will require a redox potential considerably more oxidizing than that of the couple Ni^{2+}/Ni^0 used in past experiments; this in turn will require the use of metals more noble than nickel for containers.

5.4.5.4 Subtask 4.1.1.4 Neptunium oxides

The correlation developed previously¹⁶ was used for predicting that tetravalent neptunium would behave similarly to tetravalent plutonium, although with a slightly lower distribution quotient. Since no experimental data are available, the behavior of neptunium in oxide-containing molten fluorides will be studied under various oxidizing conditions. These studies will be performed simultaneously with determinations of the redox potential, in molten fluorides in the absence of oxide ion, of couples formed by the most stable species of neptunium in solution.

5.4.6 Task 4.1.2 Tellurium chemistry

Tellurium, present in the MSBR fuel salt as a fission product, is probably responsible for the intergranular attack observed in Hastelloy N samples exposed in the MSRE experiment.²¹ This was an unexpected result and, until recently, the chemistry of tellurium in fluoride melts had not been investigated. The fuel salt is reducing, due to the U^{3+} content, and tellurium would be expected to be present as the dimer, Te_2 , and in smaller quantities as the monomer, Te , and/or in a reduced state. Two lithium tellurides are known⁶³ ($LiTe_3$ and Li_2Te) and the two telluride ions are interrelated through the following equation:

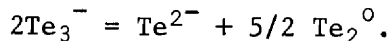

If the equilibrium constant for this reaction has a value near unity, the melt could simultaneously contain significant amounts of both ionic species. The oxidation state is, of course, controlled by the U^{3+}/U^{4+} ratio in the MSBR fuel salt, as shown in the following equation

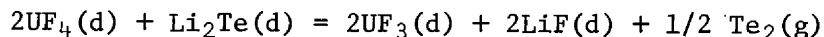

where the most reduced state of tellurium is the telluride Li_2Te . If, at U^{3+}/U^{4+} ratios attainable in an operating MSBR, the equilibrium is shifted predominately to the left, assuming Li_2Te is the stable species, the tellurium would not be available for reaction with structural metals such as Ni^0 or Cr^0 since it cannot be further reduced. If, however, Te_3^- is present, this argument may not be valid due to the disproportionation reaction yielding Te_2^0 . Conversely, if the equilibrium is shifted predominately to the right, the tellurium would be present as an elemental gas which is expected to have a very low solubility in fluoride melts and thus should distribute to the cover gas where it could possibly be removed in a side-stream purification step. Thus, it can be seen that information on these two equilibria must be developed to understand the chemistry of tellurium related to tellurium-induced cracking of Hastelloy N. The following subtasks have been defined to elucidate these reactions.

5.4.6.1 Subtask 4.1.2.1 Solubility of tellurium and tellurides in molten salts

Before a systematic investigation of the equilibria listed above can be initiated, it is necessary to determine the solubility of tellurium gas and of the solid tellurides LiTe_3 and Li_2Te in fluoride melts. This will be done first in Li_2BeF_4 , for experimental simplicity, and then in fuel salt containing thorium fluoride at temperatures ranging from 500 to 800°C to cover the expected minimum and maximum fuel salt temperatures of 1000 and 1300°F to be encountered in an operating MSBR.⁴ It has been calculated⁶⁴ that the solubility of tellurium in molten fluorides at 600°C should be approximately 10^{-11} mole fraction Te_2 and about 10^{-13} mole fraction Te. Direct measurements²² gave a value of less than 7.7×10^{-6} mole fraction at 655°C in Li_2BeF_4 . This apparent low solubility will necessitate a relatively sophisticated experimental design to obtain an accurate measurement of the solubility of tellurium. The use of radiochemical-tracer tellurium may be necessary to obtain analytical data, which could necessitate glove box isolation of the apparatus. A Henry's law constant can then be calculated for the solubility of tellurium gas in Li_2BeF_4 and in fuel salt.

The tellurides LiTe_3 and Li_2Te may be more soluble than elemental tellurium and a different experimental procedure will be required for the determination of their solubility products. Preliminary results²² suggest an appreciable solubility of LiTe_3 in molten fluorides; Li_2Te is known to be soluble to at least 0.05 mole fraction in LiCl-LiF mixtures at 525°C.⁶⁵ Prior to solubility measurements, however, it will be necessary to synthesize LiTe_3 . The Li_3Te can be purchased but most likely will have to be repurified. Attention will be drawn to the detection of significant amounts of Te_2 in the gas phase as a consequence of the dissolution of LiTe_3 . This would indicate the stability in solution of the Te_3^- . A stirred pot or rocking vessel with a graphite or boron nitride crucible or liner could be utilized in the temperature range 500-800°C for these solubility measurements. Samples for analysis would be withdrawn through filtersticks⁶⁶ and the tellurium content of the cooled samples could be determined down to the 1-10 ppm range by isotopic dilution and mass spectrometry or, at higher levels, by wet chemical analysis. If Te_3^- disproportionates significantly, the behavior of this ion would be studied spectrophotometrically with a cell and furnace in the light path of the instrument. Quartz cells were used in previous studies^{22,65} and, for longer-term stability, cells cut from single crystals of lanthanum fluoride or diamond-window graphite cells may be used. It may be possible to measure the concentration of these ions directly at temperature as a function of temperature, melt composition, Te_2 pressure, etc. Since no light absorption which would correspond to the absorption by Te^{2-} was detected,²² the determination of the solubility of Li_2Te will indicate whether Te^{2-} exhibits any absorption in the common spectral range. If the spectra overlap to some extent, it may be possible to resolve them through computer treatment of the data. Measurements would be made in both Li_2BeF_4 and thorium-containing fuel salt.

5.4.6.2 Subtask 4.1.2.2 Behavior of Te_3^- in the presence of metals of construction

Even though Te_3^- is stable in melts contained in quartz, and appears unstable in the presence of strong metallic reductants such as chromium and beryllium,²² it is necessary to know whether more noble metals and alloys (Ni, Hastelloy, etc.) can decompose the Te_3^- . This can be learned from spectrophotometric measurements similar to those described in the previous tasks.

5.4.6.3 Subtask 4.1.2.3 Oxidation-reduction chemistry of tellurium in fuel salt containing uranium

With the information developed in the two previous subtasks it will be possible to design experiments to measure the effect of the $\text{U}^{3+}/\text{U}^{4+}$ ratio in the fuel salt on the species of tellurium present and on their distribution between gas, liquid and solid phases. The solids could be insoluble tellurides of lithium or other melt constituents such as uranium telluride,^{67,68} UTe_2 . The free energies of formation of the various tellurides are not known, with the exception⁶⁹ of Li_2Te , and it is not possible to predict which telluride would be least soluble. From the results of these experiments it may be possible to propose methods for dealing with tellurium in the MSBR system.

The experiments would be carried out in a stirred vessel or rocking reactor at temperatures of 500-800°C. Provision would be made for adjusting the $\text{U}^{3+}/\text{U}^{4+}$ ratio during an experimental run. It would be desirable to use spectrophotometric methods for on-line analysis; however, if uranium absorbance negates that method it may be possible to use potentiometric methods. If the tellurium solubility is high enough, samples could be withdrawn through a filter stick and subsequently analyzed.

5.4.6.4 Subtask 4.1.2.4 Preparation of metallurgical samples

A test facility to expose metallurgical samples to controlled amounts of tellurium at elevated temperatures will be an integral part of the program described in Section 2 to develop modified Hastelloy N alloys which are resistant to tellurium intergranular attack. Facilities will be designed to simulate exposure of the MSBR containment vessel both to tellurium gas in the vapor space above the fuel salt and to contact with salt containing tellurium and/or tellurides. It is important to investigate the attack on samples in fluoride melts since the molten salt could strip protective films of oxide or fluorides from the specimens and accelerate grain boundary corrosion. For the vapor-phase exposure, the tensile test specimens and a calculated amount of tellurium metal will be placed in evacuated quartz tubes such that the sample and the tellurium can be held at different temperatures.⁷⁰ Thus, the specimen

can be maintained at any designated temperature and the deposition rate of the tellurium can be independently established. In the initial tests, a 1000-hr deposition period will be employed.

A different experimental approach will be required to simulate exposure to tellurium-containing fuel salt. Again, a reaction vessel with a graphite or boron nitride liner will be employed. The samples would be placed in the fluoride melt in the crucible and maintained at temperature. The tellurium could be transferred at a controlled rate to the melt by evaporation of tellurium metal at a lower temperature or could be added at intervals as solid Li_2Te and/or LiTe_3 .

5.4.7 Task 4.1.3 Phase behavior of PuF_3 in fuel salt

The solubility of PuF_3 in $\text{LiF-BeF}_2\text{-ThF}_4$ (72-16-12 mole %) has been measured at ORNL²⁴ and at the Bhabha Atomic Research Centre, India.²⁵ The values measured in India are about 20% lower than those at ORNL. The ORNL data resulted from three independent methods of analyses: γ - counting of the ^{241}Am present, α -pulse-height counting, and neutron activation. Determinations of plutonium in India were made by means of potentiometry and α -pulse-height counting. A reexamination of the experimental techniques employed at ORNL and, to a lesser extent of those at BARC, did not reveal the source of the discrepancy.⁷¹ The data revealed good internal consistency for each set, thus suggesting that the difference noted may be due to differences between the plutonium standards used by each analytical group.

Since Bhabha Atomic Research Centre has measured the solubility of PuF_3 in a wide composition range of molten fluorides, it seems reasonable to reevaluate the analytical methods used for plutonium at ORNL followed, if necessary, by measurements of the solubility of PuF_3 in molten fluorides of composition near that proposed for MSBR fuels.

5.4.8 Task 4.1.4 Fuel-coolant interaction studies

The conceptual design of a 1000-MW(e) MSBR power station⁴ calls for four shell-and-tube type primary heat exchangers, each having 5896 tubes of 3/8-in.-diameter and 22.2 ft in length. It is assumed that some tube failures will occur during the life of the power station; therefore, the heat exchanger design incorporates provisions for tube-bundle replacement or tube plugging by remote operation. Tube failures will, of course, lead to mixing of fuel salt and coolant. It is necessary that sufficient knowledge be developed to assure that events resulting from such mixing do not lead to consequences which could endanger the safety or viability of the reactor system.

Some experimental work has been done previously to investigate fuel and coolant mixing. In some cases, however, the results were preliminary in nature and, to some extent inconclusive, at least as far as defining practical operating parameters with regard to reactor safety. It was found²⁶ that two immiscible phases resulted when NaBF_4 or KBF_4 (these experiments did not use the eutectic coolant mixture of NaBF_4 and NaF) and various fluoride mixtures were mixed at 480°C . No chemical analyses of the major components of the phases were obtained and no BF_3 pressure measurements were made. The presence of UF_4 in the NaBF_4 -rich phase could not be detected spectrophotometrically. In another series of tests at 600°C , mixtures of NaBF_4 and Li_2BeF_4 were heated in nickel capsules, quenched, and the two phases analyzed. The resulting phases appeared to be reciprocal mixtures of the ions Li^+ , Na^+ , BF_4^- and BeF_4^{2-} and appreciable quantities of all ions were found in both phases. Changes in miscibility can occur rapidly with changes in temperature, and quenching the melt prior to sampling is not an ideal procedure since substantial redistribution of components could occur during cooling.

One series of experiments was carried out to investigate the BF_3 pressure over one mixture of $\text{LiF}-\text{BeF}_2-\text{ThF}_4$ (72-16-12 mole %) and NaBF_4-NaF (92-8 mole %) coolant.⁷² The mixture was not stirred and was slowly heated in an autoclave. Pressure readings were recorded to 647°C where an overpressure of 95 psia was obtained. The magnitude of the reported pressure was 13 times higher than the BF_3 pressure over NaBF_4-NaF (92-8 mole %) at a given temperature. Equilibration was achieved only slowly, and the pressure continued to increase after the measurements were recorded and BF_3 was then vented to the hood. The BF_3 can be considered to be generated by dissociation of the NaBF_4 and dissolution of the NaF in the fuel salt, thus lowering the NaF activity

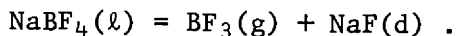

Questions concerning the attainment of equilibrium in this experiment suggest that the results may not represent the maximum pressure. Also, the investigation covered only one ratio of fuel and coolant.

Subsequently, a careful investigation of the solubility of BF_3 in fuel salt was completed³⁶ and the equilibrium BF_3 pressures were measured for several molten salt compositions over a wide temperature range. In some experiments NaF was added, giving a composition of $\text{LiF}-\text{BeF}_2-\text{ThF}_4-\text{NaF}$ (66-15-11-8 mole %) to simulate the in-leakage of NaBF_4 coolant to fuel salt. The equilibrated molten salt was not examined for two-phase formation but discontinuities were not encountered in the BF_3 pressure data, suggesting that no phase disengagement occurred. Consideration of the result of small leaks and massive leaks of coolant into fuel indicated that excessive BF_3 pressures would not be encountered.

In the operation of a large pump loop with NaBF_4 - NaF (92-8 mole %) coolant,⁷³ a uranium-and thorium-containing precipitate was obtained which resulted from the mixing of residual fuel salt in the loop with the flush charge of coolant. This was reported²⁷ to be $7\text{NaF}\cdot 6(\text{Th},\text{U})\text{F}_4$. These results are consistent with the previous finding²⁶ that UF_4 was insoluble in NaBF_4 .

These experiments are subject to criticism in that they are in some instances (a) preliminary, (b) do not cover the temperature range of 850-1300°F expected in the primary heat exchangers,⁴ (c) cover only one or a limited range of fuel-coolant ratios and, (d) in one case, represent a relatively uncontrolled mixing experiment. Regardless, it is possible to draw some generalized conclusions concerning the results of mixing.

If fuel leaks into the coolant, the uranium and thorium will precipitate. Probably most or all of the trivalent or higher-valent cations, such as protactinium, fission products, etc., would also precipitate. Two immiscible phases may be formed when large volumes of fuel leak into the coolant and many of the constituents may distribute between these phases. In addition, radioactive contamination of the coolant system would result.

If coolant leaks into the fuel, it is less clear what events will occur. The NaBF_4 will partially dissociate and BF_3 gas will be evolved. It is not known if this would evolve smoothly or in surges as the two immiscible liquids reacted. Eventually, after some unknown volume of coolant mixes with fuel, two stable immiscible phases may be formed and all the ions may distribute between these two phases. It is not possible to predict what the uranium or thorium concentration would be in each phase. In addition, of course, boron is a nuclear poison and must be removed (as BF_3 gas) for the fuel to be operable; very small concentrations would be removed by neutron absorption.

In order to resolve these important safety-related questions, the following subtasks have been defined to investigate the phase equilibria, the distribution of major and minor components between the two phases and to simulate the dynamic non-equilibrium conditions to be encountered in an actual leak. Leaks in either direction through the heat exchanger will be considered; fuel into coolant as well as coolant into fuel. The experiments should also indicate the events to be encountered in transient situations, for example cooling the salt after reactor shutdown following detection of a leak. Since phase immiscibility can be highly temperature dependent, two-phase formation could be more pronounced at lower temperatures during cool down. If there is substantial distribution of the components between the phases, the freezing point of the new phases could be substantially different from fuel or coolant. If the freezing point is higher, then material could freeze in the heat exchanger in the vicinity of a leak.

5.4.8.1 Subtask 4.1.4.1 Phase equilibria

The preliminary experiments²⁶ suggested that two immiscible phases could be formed when fuel and coolant were mixed, but the ratio of fuel to coolant over which this behavior occurs and the composition of the phases were not well defined. The first series of experiments will investigate the mixing at wide ranges of fuel/coolant ratio, thus simulating leaks in either direction through the primary heat exchanger, and over a temperature range from the maximum anticipated temperature to the freezing point of the phases. The experiments will be designed so that the volume of the resulting phases can be measured and the phases can be sampled at temperature. For short term experiments, quartz containment may be adequate and would simplify observation of the two phases. For longer term experiments at the higher temperatures, the experiments could be repeated in nickel or Hastelloy N reactors to avoid SiF_4 and oxide contamination of the melt. The conductivity of the two phases may be sufficiently dissimilar that an adjustable conductivity probe could be used to locate the interface. A complete analysis would be performed for all melt constituents, both major and minor. The pressure would be maintained arbitrarily at 1 atmosphere and the quantity of BF_3 evolved would be measured. It may be necessary to stir the reaction vessel to ensure rapid attainment of equilibrium. Since, in an MSBR, the gas space over the fuel will be swept with helium, it may be desirable to subsequently introduce that feature in the experimental design to evaluate the residual BF_3 composition of the melt. With the information developed in these experiments, it will be possible to evaluate the problems of phase immiscibility, uranium and thorium distribution and precipitation, and freezing point depression.

Additional experiments may then be needed to define the distribution of plutonium and possibly other actinides since some MSBR concepts include using plutonium as the initial fuel, and molten-salt converter reactors could operate with plutonium fuel makeup. It is desirable to investigate the distribution of fission product elements in the two-phase system. If radioactive tracers are used, these experiments may require some shielding.

5.4.8.2 Subtask 4.1.4.2 Dynamic investigations

The phase equilibria experiments described in the preceding section plus the previously completed BF_3 pressure data³⁶ will be adequate to evaluate the effect of small leaks. Large leaks, or the sudden mixing of large volumes of fuel and coolant, present a more complex situation. They involve a non-equilibrium situation and dynamic experiments must be carried out to investigate reaction rates in addition to equilibrium conditions.

The rate of evolution of BF_3 gas following a sudden mixing is important in determining the maximum transient pressure in a damaged heat exchanger and in evaluating the potential for physical failure of the heat exchanger shell. To measure the rate of reaction of coolant and fuel, a suitable experimental stand allowing for pressure transients would be required. Pressure transducers capable of recording pressure transients would be utilized and volumes of fuel and coolant would be mixed under well defined conditions.

In the case of a leak of coolant into fuel salt, the environment in the area near the leak will be high in BF_4^- concentration, and insoluble fluorides such as the $7\text{NaF}\cdot 6(\text{Th},\text{U})\text{F}_4$ previously observed²⁷ may be formed. These would be dispersed by the fuel salt flow and mixed into the bulk of the fuel salt in the reactor. If they do not readily redissolve, deposits of solids could develop; thus, the rate of redissolution of the uranium-thorium precipitate in fuel salt needs to be examined. Typical solid precipitates would be prepared and their rate of dissolution studied. These experiments could be carried out in conventional stirred nickel reactors and the contents sampled.

The possibility of freezing a phase having a higher melting point in the vicinity of a leak due to non-equilibrium concentrations near the leak would be investigated. In addition to mathematical simulation of the heat transfer in such a situation, a test apparatus could be built to demonstrate the potential for freezing with various controlled leak rates.

5.4.9 Task 4.1.5 Physical property determinations on fuel salt

The last critically-compiled set of physical properties of possible fuel salt compositions was reported²⁸ in August 1968. Since then, density and viscosity of several fluoride melts have been measured.²⁹ From these measurements, the density and viscosity of fuel salt are known, respectively, to $\pm 3\%$ and $\pm 10\%$. The heat-capacity of fuel salt $\text{LiF}-\text{BeF}_2-\text{ThF}_4$ (72-16-12 mole %) has been derived from drop calorimetry;²⁸ on the basis of this determination and a simple model for predicting heat capacity of molten fluorides, one can reliably predict the heat-capacity of the fuel salt.

Thermal conductivity is the key property for predicting heat-transfer coefficients of molten fluorides. Measurements that are probably accurate to ± 10 to 15% have been obtained for $\text{LiF}-\text{BeF}_2-\text{ThF}_4-\text{UF}_4$ (67.5-20-12-0.5 mole %).⁷⁴ It will be helpful for future design considerations to develop an apparatus to measure thermal conductivities of fluorides with greater accuracy and to determine the conductivity of the presently proposed fuel salt composition in such an apparatus.

The surface physical properties (surface tension and interfacial tension between salt and graphite) are only known qualitatively. Such properties are important in assessing wetting behavior and in determining the degree of penetration of salt into graphite.

The vapor pressure, as yet unmeasured, has been extrapolated from measurements of LiF-BeF₂ and LiF-UF₄ mixtures. At the highest normal operating temperature, 704°C, the estimated vapor pressure is approximately 10⁻² torr. The vapor composition has not been measured but would be considerably enriched in BeF₂ and, perhaps, in ThF₄. Vapor pressure and vapor composition are not high-priority measurements. However, calculations of how much salt and of what composition is transported by gas sparging to cool portions of the off-gas system in the primary system will require something more than qualitative estimates. A transpiration experiment would provide firm values of vapor composition and improved values of the vapor pressure. Manometric measurements combined with mass-spectrographic determination would provide more precise information on both.

5.4.9.1 Subtask 4.1.5.1 Thermal conductivity

An investigation would be made to determine if the variable-gap apparatus previously used⁷⁵ is suitable for further measurements. If not, consideration would be given as to whether a modified variable-gap, hot-wire, or some other technique might be more suitable. There is also some virtue in testing all molten-salt thermal conductivity data against models by which thermal conductivity can be adequately predicted.

5.4.9.2 Subtask 4.1.5.2 Surface properties

A visual sessile-drop apparatus would be assembled to examine contact angles of fuel salt on graphites; the same general apparatus would be used with liquid metals and salts of interest to chemical processing. Apparatus would be assembled and operated to measure surface tension of salts (and perhaps metals) by the maximum bubble pressure technique. The salt-graphite interfacial studies initiated previously would be completed.

5.4.9.3 Subtask 4.1.5.3 Vapor pressure and composition

The pressure and composition of vapor of MSBR fuel salt would be measured by a combination of transpiration, vapor-pressure and mass-spectrographic determinations over the temperature range 500° to 1400°C.

5.4.10 Task 4.1.6 U³⁺/U⁴⁺ equilibria studies

Experience with the fuel salt redox chemistry has shown that the upper and lower limits of the U³⁺/U⁴⁺ ratio that are permissible in an MSBR are governed by several factors. The ratio must be high enough to prevent corrosion of the container through the reaction:

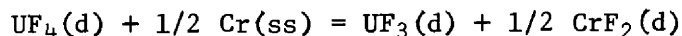

and to prevent the precipitation of Pa_2O_5 through the reaction:

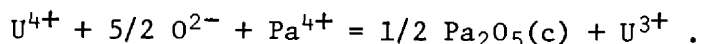

It has been estimated⁷⁶ that ratios greater than 0.05 should be adequate in controlling both of these processes.

On the other hand, the ratio must be low enough to prevent reaction of U^{3+} with graphite through the reaction

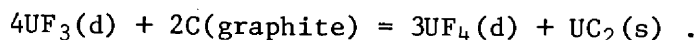

It has been shown³⁰ that, at 550°C, ratios less than 0.1 for typical fuel salt concentrations will be stable in solutions with free fluoride ion concentrations similar to Li_2BeF_4 . Evidence has also been found³⁰ which suggests that oxide impurities may shift the above carbide equilibrium to the right by the formation of more stable uranium oxycarbide phases. If such oxycarbide phases do indeed form, the $\text{U}^{3+}/\text{U}^{4+}$ ratio may have to be held at values less than 0.1.

The effect of oxygen-related impurities on the UF_3 - UF_4 solution equilibrium will be examined to determine to what extent low concentrations of oxide shift the maximum $\text{U}^{3+}/\text{U}^{4+}$ ratio which is otherwise determined by $4\text{UF}_3(\text{d}) + 2\text{C}(\text{graphite}) = 3\text{UF}_4(\text{d}) + \text{UC}_2(\text{s})$. The possible formation of uranium oxycarbide phases when U^{3+} reacts with graphite in the presence of oxide ion will be examined from 450 to 700°C. Identification of these phases will be made and related to the oxide ion concentration of the melt and/or oxygen partial pressure over the system.

The chief experimental technique to be used in this study is the measurement of UF_3 and UF_4 concentrations of fuel salts in the temperature range of interest using a diamond-windowed cell.⁷⁷ Spectra in the near-infrared and visible regions will be generated by means of a Cary-14 H spectrometer. In addition, long term equilibration studies will be conducted in sealed containers involving larger amounts of material in an effort to generate, identify and characterize possible uranium oxycarbide phases or other solid mixed-composition phases. Several analytical tools will be used to characterize the isolated phases, such as x-ray diffraction, chemical analysis, petrography and metallography.

5.5 TASK GROUP 4.2 COOLANT SALT CHEMISTRY

5.5.1 Objective

The objective of this task group is to develop an understanding of the chemical parameters of the coolant. Particular emphasis will be given to tritium trapping and corrosion reactions. This portion of the program plan is complicated by the possible selection of an alternate coolant in place of fluoroborate. If that occurs, the program plan must be changed in light of the research needed for the new coolant.

5.5.2 Schedule

The schedule for work in this task group is given in Table 5.5.2.

5.5.3. Funding

The operating fund requirements for this task group are summarized in Table 5.5.3.1, and the capital equipment fund requirements are summarized in Table 5.5.3.2.

5.5.4 Facilities

No special facilities are needed for this research. Existing laboratories in Building 4500S are adequate.

5.5.5 Task 4.2.1 Oxide and hydroxide chemistry of fluoroborate

The presence of oxide and hydroxide species in $\text{NaBF}_4\text{-NaF}$ (92-8 mole %), even in low concentrations, will have effects on corrosion of the Hastelloy N and on reactions with tritium. At higher concentrations, as would occur if steam leaked into the coolant circuit, more extensive corrosion would occur; in addition, the vapor over the coolant would change from all BF_3 to vapor species also containing hydrogen and oxygen. The hydrogen-containing species may be important in sparging tritium out of the coolant circuit. The experimental efforts of the past¹ have barely begun to elucidate the important, but complex, chemistry of these species.

It is clear that a much more complete understanding of oxide and hydroxide species will have to be achieved before these species can be employed in schemes to control tritium migration, before corrosion can be accurately predicted, or fluoroborate produced at the required purity.

Table 5.5.2. Schedule for work in Task Group 4.2 - Coolant salt chemistry

	Fiscal year											
	1975	1976	1977	1978	1979	1980	1981	1982	1983	1984	1985	1986
4.2.1 Oxide and hydroxide chemistry of fluoroborate												
4.2.1.1 Identification of oxide-containing species												
4.2.1.2 Reactions of H ₂ O with NaBF ₄												
4.2.1.3 Tritium trapping in fluoroborate												
4.2.2 Corrosion chemistry of fluoroborate												
4.2.2.1 Free energy of formation of corrosion products												
4.2.2.2 Boride formation												
4.2.3 Coolant purification												
4.2.3.1 Initial purification												
4.2.3.2 In-reactor purification												
4.2.4 Alternate coolant evaluation												
4.2.4.1 Interim report												
4.2.4.2 Final evaluation												
4.2.5 Physical property determinations on coolants												
4.2.5.1 Thermal conductivity												
4.2.5.2 Surface tension												
4.2.5.3 Solubility of corrosion products												
4.2.5.4 Other physical properties of fluoroborate and alternate coolants												

Table 5.5.3.1. Operating fund requirements for Task Group 4.2 - Coolant salt chemistry
(costs in 1000 dollars)

	Fiscal year											
	1975	1976	1977	1978	1979	1980	1981	1982	1983	1984	1985	1986
4.2.1 Oxide and hydroxide chemistry of fluoroborate												
4.2.1.1 Identification of oxide-containing species	30	30	15	15	5	5						
4.2.1.2 Reactions of H ₂ O with NaBF ₄	25	25	20	20	15	15						
4.2.1.3 Tritium trapping in fluoroborate			20	138	140	155	190	155	55			
Subtotal 4.2.1	55	55	55	173	160	175	190	155	55			
4.2.2 Corrosion chemistry of fluoroborate												
4.2.2.1 Free energy of formation of corrosion products	80	80	50	35	25	25	10					
4.2.2.2 Boride formation		15	25									
Subtotal 4.2.2	80	95	75	35	25	25	10					
4.2.3 Coolant purification												
4.2.3.1 Initial purification					35	40	40					
4.2.3.2 In-reactor purification							30	55	110	55	55	
Subtotal 4.2.3					35	40	70	55	110	55	55	

Table 5.5.3.1 (continued)

	Fiscal year												
	1975	1976	1977	1978	1979	1980	1981	1982	1983	1984	1985	1986	
4.2.4 Alternate coolant evaluation													
4.2.4.1 Interim report	30												
4.2.4.2 Final evaluation	—	30	50	10									
Subtotal 4.2.4	30	30	50	10									
4.2.5 Physical property determinations on coolants													
4.2.5.1 Thermal conductivity							20	20					
4.2.5.2 Surface tension								30	25				
4.2.5.3 Solubility of corrosion products						30	35	55	30	55			
4.2.5.4 Other physical properties of fluoroborate and alternate coolants							10	45					
Subtotal 4.2.5						30	65	150	55	55			
Total operating funds for Task Group 4.2	165	180	180	218	220	270	335	360	220	110	55		

Table 5.5.3.2. Capital equipment fund requirements for Task Group 4.2 -- Coolant salt chemistry
(costs in 1000 dollars)

	Fiscal year									
	1975	1976	1977	1978	1979	1980	1981	1982	1983	1984
4.2.1 Oxide and hydroxide chemistry of fluoroborate										
4.2.1.1 Identification of oxide-containing species	20	20	20	5						
4.2.1.2 Reactions of H ₂ O with NaBF ₄		15	10	10						
4.2.1.3 Tritium trapping in fluoroborate			75	75	50	10				
Subtotal 4.2.1	20	35	105	90	50	10				
4.2.2 Corrosion chemistry of fluoroborate										
4.2.2.1 Free energy of formation of corrosion products	5	5	5							
4.2.2.2 Boride formation		5								
Subtotal 4.2.2	5	10	5							
4.2.3 Coolant purification										
4.2.3.1 Initial purification					2	2				
4.2.3.2 In-reactor purification							5	50	10	
Subtotal 4.2.3					2	2	5	50	10	
4.2.5 Physical property determinations on coolants										
4.2.5.1 Thermal conductivity							40	20		
4.2.5.2 Surface tension								60	30	
4.2.5.3 Solubility of corrosion products						10	5	5		

Table 5.5.3.2 (continued)

	Fiscal year									
	1975	1976	1977	1978	1979	1980	1981	1982	1983	1984
4.2.5.4 Other physical properties of fluoroborate and alternate coolants							25	10		
Subtotal 4.2.5						10	70	95	30	
Total capital equipment funds for Task Group 4.2	25	45	110	90	52	22	75	145	40	

5.5.5.1 Subtask 4.2.1.1 Identification of oxide-containing species

The chemical formula and structure of oxide and hydroxide species both in the melt and in the vapor are vital information that will be applied to the practical problems of corrosion, tritium control and impurity removal in fluoroborate coolant.

The ion BF_3OH^- has been positively identified in fluoroborate coolant from measurements of its infrared absorption spectrum.³³ This species, in low concentration at 425°C, is apparently stable for a few days. Infrared study of the melts suggests that one or more additional oxygen-containing species are also present.³³ Solid NaBF_3OH has been reported⁷⁸ to undergo a bimolecular condensation reaction at 100-120°C to yield $\text{H}_2\text{O}(\text{g})$ and $\text{Na}_2\text{B}_2\text{F}_6\text{O}$. The same paper notes that, at 240°C, $\text{Na}_2\text{B}_2\text{F}_6\text{O}$ disproportionates into $\text{Na}_3\text{B}_3\text{F}_6\text{O}_3$ and NaBF_4 . It is possible that these oxides may exist in molten fluoroborate.

These complex oxides along with some other related compounds will be synthesized for the purposes of "finger printing" (by infrared, NMR, and other techniques) and to study their dissolution and volatilization behavior in molten fluoroborate. The compounds to be prepared will include $\text{Na}_2\text{B}_2\text{F}_6\text{O}$, $\text{Na}_3\text{B}_3\text{F}_6\text{O}_3$, $\text{Na}_3\text{B}_3\text{F}_5\text{O}_3(\text{OH})$, $\text{BF}_3 \cdot \text{H}_2\text{O}$, $\text{BF}_3 \cdot 2\text{H}_2\text{O}$, BF_2OH and $\text{BF}_2\text{OH} \cdot \text{H}_2\text{O}$. This list is necessarily tentative because investigations of reactivity and volatilization may decrease (or possibly increase) the number of significant species in molten fluoroborate or its vapor. Nuclear magnetic resonance (proton, fluorine, boron-11) will be the primary tool by which volatile species will be identified. Infrared absorption spectra will be used for identifying species in the solid or liquid states.

5.5.5.2 Subtask 4.2.1.2 Reaction of H_2O with NaBF_4

Hydrolysis equilibria, the simplest of which may be written as $\text{H}_2\text{O}(\text{g}) + \text{NaBF}_4(\text{d}) = \text{NaBF}_3\text{OH}(\text{d}) + \text{HF}(\text{g})$, are particularly important in assessing corrosion, in devising tritium control schemes, and in coolant purification. Study of these equilibria is hampered by the presence of gaseous BF_3 and B-O-F compounds and possibly by condensation of NaBF_3OH into one or more complex oxides. Nevertheless, fluoroborates have been purified to some extent by sparging with gaseous mixtures of HF and BF_3 ,⁷⁹ the latter serving to maintain the composition of the melt. The limited success of this procedure suggests that the reverse of the above reaction may be used for initial purification of fluoroborate if vendors cannot supply adequately purified material (see Task 4.2.3).

Hydrolysis equilibria will be investigated in parallel with the synthesis and identification efforts (see Subtask 4.2.1.1). Composition of solid, liquid and vapor phases will be studied at MSBR operating temperatures, depending primarily, but not exclusively, upon chemical analysis and upon infrared and NMR spectra.

5.5.5.3 Subtask 4.2.1.3 Tritium trapping in fluoroboroate

An important development objective in the development of molten-salt reactors (converters as well as breeders) is to prevent all, or virtually all, of the tritium which diffuses into the coolant circuit from reaching the steam system. The fluoroborate coolant offers a reasonable potential for meeting this objective through two types of chemical reaction — oxidation and isotope exchange.

Initial attempts⁸⁰ to exchange deuterium for the protium in the ionic species BF_3OH^- were not successful. Instead, BF_3OD^- formed in the melt; this result suggested that oxidation (by structural metal ions) of deuterium occurred rather than isotope exchange. By inference, then, oxidation of tritium may be the more fruitful path toward trapping tritium in the coolant. The reaction

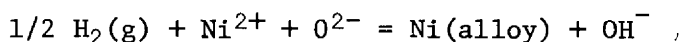

will be studied in a systematic fashion.

Tritium removal schemes via complex volatile species will be investigated after sufficient information has been obtained about these species (Subtasks 4.2.1.1 and 4.2.1.2).

If oxidation reactions can successfully lead to trapping of tritium in fluoroborate coolant, it will still be necessary to process the coolant for removal of the tritium. Reaction with CF_4 may be effective in this regard. Study of the reaction

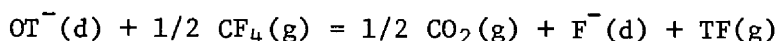

would follow the demonstrated capability of using CF_4 in purification of the coolant (see Subtask 4.2.3.2).

5.5.6 Task 4.2.2 Corrosion chemistry of fluoroborate

5.5.6.1 Subtask 4.2.2.1 Free energy of formation of corrosion products

The chemical nature of the coolant will be a significant factor in fixing the form and stability of the containment metals that are oxidized (i.e., corroded) during reactor operations. With fluoroborate coolant salts, loop and capsule experiments have shown that Ni^{2+} , Fe^{2+} , and Cr^{3+} ions are slightly soluble corrosion products. When the solubility limit of these ions is exceeded, they precipitate as ionic complex compounds — NaNiF_3 , NaFeF_3 , Na_3CrF_6 . The free energies of formation (ΔG_f°) of these compounds must be known not only to characterize the extent of corrosion in fluoroborates, but also to predict what redox reactions are likely to reverse or counter the metal oxidation. The free energies of formation of NaNiF_3 and NaFeF_3 have already been published.³⁵ Experiments are underway to obtain ΔG_f° of Na_3CrF_6 by means of the reaction,

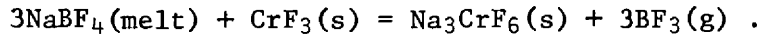

By combining the measured partial pressure of BF_3 , the previously determined activity of NaBF_4 ,⁸¹ and the published⁸² ΔG_f° of $\text{CrF}_3(\text{s})$, ΔG_f° of Na_3CrF_6 will be obtained.

It should be noted that the chemical formula and stability of chromium, nickel and iron corrosion products formed in other NaF-containing coolants may be similar to those which form in fluoroborate coolant.

Since titanium is a significant constituent of MSBR containment alloys, the corrosion thermodynamics of titanium in the coolant will also be studied. This includes investigations of the stability of trivalent titanium and of the existence and solubility of Na_3TiF_6 , NaTiF_4 or other complex salts.

5.5.6.2 Subtask 4.2.2.2 Boride formation

Boron in fluoroborate coolant may possibly oxidize constituents of the containment alloys such that reduced boron may deposit on metal surfaces. Two examples of such possible reactions with negative standard free energy changes are:

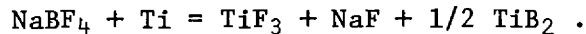
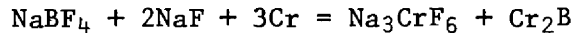

(The latter reaction may lead to Na_3TiF_6 , whose formation free energy will be investigated under Subtask 4.2.2.1). If boron deposition should occur in MSBR primary heat-exchangers and if the diffusivity of the boron in Hastelloy N is sufficiently high, embrittlement of the Hastelloy N might result via helium produced by delayed neutrons in the reaction $^{10}\text{B}(n,\alpha)^7\text{Li}$. On the other hand, if the deposited boron remained on the metal surface, radiation damage would be of little consequence. Thus, as long as fluoroborate is a candidate coolant for breeder reactors, it is necessary to investigate boride formation and diffusion in metals used in the primary heat exchangers.

Initial experiments of boride formation on Hastelloy N and other alloys will be carried out with specimens in contact with NaBF_4 -NaF (92-8 mole %) for times varying between two weeks and six months; the specimens will be analyzed for boron penetration. If these results indicate significant penetration of boron into metal specimens, accurate determinations of boron diffusion rates will be carried out.

5.5.7 Task 4.2.3 Coolant purification

5.5.7.1 Subtask 4.2.3.1 Initial purification

It is known from loop tests that deliberate addition of water, even in rather small quantities, will amplify the corrosivity of fluoroborate coolant.⁸³ It is, therefore, necessary for the salt to be as dry as practicable. Commercially available NaBF₄, when recrystallized from dilute aqueous HF, can be purified to concentrations as low as 4 ppm in protons and 200 ppm in oxide.⁸⁴ Other impurities that cause corrosion are metallic ions, notably ferrous or ferric ions; these may be introduced into commercial NaBF₄ when steel equipment is used in the salt preparation. It is also necessary to guard against the introduction of impurities such as cobalt which would be easily activated by delayed neutrons in the primary heat-exchangers. There is a need to contact and work with a vendor (presumably Harshaw) to determine how the bench-scale purification can be scaled-up and how harmful metallic ions can be either kept out or minimized in the delivered product. If the vendor cannot supply an adequately purified material, application of the HF(g) + BF₃(g) sparging method should be strongly considered (see Subtask 4.2.1.2).

5.5.7.2 Subtask 4.2.3.2 In-reactor purification

During the life of an MSBR there is a finite probability that a steam leak will occur and that it will be necessary to process the coolant for proton removal and possibly to lower the oxide concentration. Corrosion will have to be kept at a low level to prevent entrained solids (like Na₃CrF₆) from clogging coolant passages in steam generators and heat exchangers. Accurate solubilities of corrosion product ions should be known (see Section 5.5.9.3, Subtask 4.2.5.3). Practical on-line purification as well as tritium removal probably involves designing by-pass facilities (such as a coolant drain tank lined with graphite) where one or more processing operations can be carried out. A possible method for removing oxide and protons (tritons) from the coolant involves reactions with CF₄:

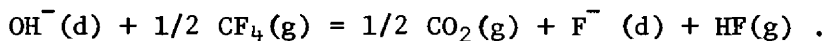

Preliminary experiments⁸⁵ failed to identify CO₂ as a reaction product, but this may have been due to difficulties in analyzing a complicated effluent gas stream containing HF, H₂O, BF₃, CO₂ and unreacted CF₄. A combination of gas chromatographic, mass-spectrographic and infrared analytical methods should solve these difficulties. Experimental work would focus on the equilibrium aspects of the above reactions. However, studies of catalysis may be necessary should these reactions prove to proceed slowly.

5.5.8 Task 4.2.4 Alternate coolant evaluation

Although it now appears that the fluoroborate coolant, $\text{NaBF}_4\text{-NaF}$ (92-8 mole %), can be utilized in an MSBR system with suitable compromise of design parameters and previous considerations of alternate coolants have not revealed a more ideal coolant, it was deemed desirable to make a reevaluation of the coolant selection. Less than ideal attributes of the fluoroborate are its high melting point and corrosivity toward Hastelloy N upon the addition of moisture. Experimentally unresolved aspects include compatibility with fuel salt and tritium trapping. Therefore, alternate coolants will be evaluated.

5.5.8.1 Subtask 4.2.4.1 Interim report

In this investigation, fluoroborate and other fluids will be evaluated in terms of the constraints and requirements imposed upon the coolant of an MSBR. Nine general attributes (constraints and requirements) have been identified:

1. The consequences of accidental mixing of coolant and fuel must be minimal and reversible.
2. It is highly desirable that the coolant should sequester virtually all tritium diffusing into the coolant circuit.
3. The coolant must be compatible with components which it contacts normally.
4. Leaks in the steam-raising system must be tolerable.
5. Radiation within the primary heat-exchanger should have minimal detrimental effects upon the vapor pressure, composition and compatibility of the coolant.
6. The coolant should have acceptable heat-transfer and fluid properties; the properties of the coolant should not necessitate a greatly increased fuel inventory, thereby lessening the breeding performance of the reactor.
7. The coolant should have a freezing point below 600°F.
8. The coolant should exhibit a low vapor pressure at normal operating temperatures.
9. The coolant should be inexpensive and available in high purity.

An in-depth evaluation of potential coolants is underway. Since it is possible that a single coolant may not fill all the requirements of an MSBR, consideration will also be given to two-coolant loops.⁷ A draft report will be prepared and circulated for comment. Comments will be discussed and incorporated into a final report.

5.5.8.2 Subtask 4.2.4.2 Final evaluation

The results of the previous subtask will include recommendations for laboratory experiments. The results of these experiments will have an important bearing on the ultimate selection of the coolant. When the coolant evaluation is completed, a final report containing the results and recommendations will be issued.

5.5.9 Task 4.2.5 Physical property determinations on coolants

The number of measurements and general effort required will depend, to some extent, upon the coolant chosen on the basis of the assessment (Task 4.2.4) currently underway. Viscosity,²⁹ density,²⁹ and heat capacity⁸⁶ of NaBF₄-NaF (92-8 mole %) are known with sufficient accuracy for most purposes.

5.5.9.1 Subtask 4.2.5.1 Thermal conductivity

If NaBF₄-NaF (92-8 mole %) is the ultimate selection as the coolant, its thermal conductivity should be determined with higher precision than previously reported.⁸⁷ The apparatus should be the same as that used for determining thermal conductivity of the fuel salt (see 5.4.9.1, Subtask 4.1.5.1).

5.5.9.2 Subtask 4.2.5.2 Surface tension

The surface tension of the coolant should be measured in the same apparatus as that used for the fuel salt (see 5.4.9.2, Subtask 4.1.5.2).

5.5.9.3 Subtask 4.2.5.3 Solubility of corrosion products

In order to properly assess the consequences of corrosion by the coolant, it is necessary to have an adequate data base. Corrosion-product solubility as a function of temperature is an integral component of the data base. In fluoroborate coolant, the solubility of Na₃CrF₆ (a corrosion product observed in virtually all loop tests) has been measured. However, the reported data³⁴ were quite scattered in the range 450-550°C; also, the data were obtained at lower NaF concentrations than would be used in the fluoroborate coolant. Since removal of Na₃CrF₆ would be important in any coolant loop containing fluoroborate, it would be useful to determine more accurately the solubilities of Na₃CrF₆ in NaBF₄-NaF (92-8 mole %). Once corrosion of chromium becomes limited by diffusion within Hastelloy N, structural metal corrosion in fluoroborate becomes the oxidation of nickel; the corrosion product, Ni²⁺, will precipitate when the coolant is saturated with Ni²⁺. Accordingly, solubility measurements of NiF₂ in fluoroborate are very desirable.

5.5.9.4 Subtask 4.2.5.4 Other physical properties of fluoroborate and alternate coolants

If an alternate coolant is chosen, physical properties would be determined as required. For instance, if a BeF_2 -containing salt were the candidate, the viscosity should probably be measured.

If fluoroborate is retained as coolant, the density change upon melting should be measured. This information is probably necessary in order to predict stresses that may occur in the steam-raising system, assuming some of the coolant is allowed to freeze on baffle plates, etc.

5.6 TASK GROUP 4.3 TRITIUM BEHAVIOR

5.6.1 Objective

The objective of this task group is to obtain the data and develop the technology necessary to limit to acceptable levels the rate at which tritium is released from molten-salt reactors.

The necessary data include permeabilities, solubilities, and diffusivities of tritium, both pure and mixed with other hydrogen isotopes, in salts and metals, and information on equilibria and reactions between tritium and materials present in an MSBR. A major objective is to determine whether an oxide film can be formed on the steam side of the steam generator which will significantly reduce the tritium permeation rate.

5.6.2 Schedule

The schedule for work in this task group is given in Table 5.6.2.

5.6.3 Funding

The operating fund requirements for this task group are summarized in Table 5.6.3.1, and the capital equipment fund requirements are summarized in Table 5.6.3.2.

5.6.4 Facilities

Construction of a high-pressure, high-temperature steam loop test facility may be required as part of the study of oxide stability in steam systems, Subtask 4.3.1.2. This major facility would permit studies to be made of the solubilities, transport, and long-term effectiveness of oxide films as tritium barriers. Control of the steam chemistry and capability of handling tritium could be achieved in the facility. Both permeation rates and chemical changes of oxides with time could be studied. The facility would cost approximately \$200,000 and would require approximately two years for design and construction.

Table 5.6.2. Schedule for work in Task Group 4.3 - Tritium behavior

	Fiscal year											
	1975	1976	1977	1978	1979	1980	1981	1982	1983	1984	1985	1986
4.3.1 Permeation studies												
4.3.1.1 Permeation of clean and oxidized metals												
4.3.1.2 Stability of oxides in steam systems												
4.3.2 Solubility of tritium-containing species in molten salts												
4.3.2.1 Solubility of tritium in fuel salt												
4.3.2.2 Solubility of tritium in coolant salt												
4.3.2.3 Solubility of tritium fluoride in fuel salt												
4.3.3 Equilibria between important species containing tritium in salt-gas systems												
4.3.3.1 Fuel salt equilibria												
4.3.3.2 Coolant salt equilibria												
4.3.4 Isotopic exchange between tritium and chemically bound hydrogen												
4.3.5 TF corrosion behavior at low TF activity												

Table 5.6.2 (continued)

	Fiscal year											
	1975	1976	1977	1978	1979	1980	1981	1982	1983	1984	1985	1986
4.3.6 Diffusivity studies												
4.3.6.1 Diffusivity of HT and H ₂ in fuel salt												
4.3.6.2 Diffusivity of tritium in coolant salt												
4.3.6.3 Diffusivity of HF and TF in fuel salt												
4.3.6.4 Diffusivity of HF and TF in coolant salt												
4.3.7 Modeling of tritium behavior in molten-salt reactors												
4.3.8 Tritium absorption on carbon in contact with the coolant												

Table 5.6.3.1. Operating fund requirements of Task Group 4.3 - Tritium behavior
(costs in 1000 dollars)

	Fiscal year												
	1975	1976	1977	1978	1979	1980	1981	1982	1983	1984	1985	1986	
4.3.1 Permeation studies													
4.3.1.1 Permeation of clean and oxidized metals		55	55	55	55								
4.3.1.2 Stability of oxides in steam systems					25	110	110	165	125				
Subtotal 4.3.1		55	55	55	80	110	110	165	125				
4.3.2 Solubility of tritium-containing species in molten salts													
4.3.2.1 Solubility of tritium in fuel salt			50	55	55	55							
4.3.2.2 Solubility of tritium in coolant salt							55	55	75	35			
4.3.2.3 Solubility of tritium fluoride in fuel salt							55	55	35				
Subtotal 4.3.2			50	55	55	55	110	110	110	35			
4.3.3 Equilibria between important species containing tritium in salt-gas systems													
4.3.3.1 Fuel salt equilibria				55	55	50							
4.3.3.2 Coolant salt equilibria					30	55	55	55	25				
Subtotal 4.3.3				55	85	105	55	55	25				
4.3.4 Isotopic exchange between tritium and chemically bound hydrogen							25	75	75	55			

Table 5.6.3.1 (continued)

	Fiscal year											
	1975	1976	1977	1978	1979	1980	1981	1982	1983	1984	1985	1986
4.3.5 TF corrosion behavior at low TF activity									35	55		
4.3.6 Diffusivity studies												
4.3.6.1 Diffusivity of HT and H ₂ in fuel salt								30	55			
4.3.6.2 Diffusivity of tritium in coolant salt								25	55	110	55	
4.3.6.3 Diffusivity of HF and TF in fuel salt										55	110	
4.3.6.4 Diffusivity of HF and TF in coolant salt									25	35	75	
Subtotal 4.3.6								55	135	200	240	
4.3.7 Modeling of tritium behavior in molten-salt reactors									10	20	35	
4.3.8 Tritium absorption on carbon in contact with the coolant							25	55	35			
Total operating funds for Task Group 4.3		55	105	165	220	270	325	515	550	365	275	

Table 5.6.3.2. Capital equipment fund requirements for Task Group 4.3 - Tritium behavior
(costs in 1000 dollars)

	Fiscal year											
	1975	1976	1977	1978	1979	1980	1981	1982	1983	1984	1985	1986
4.3.1 Permeation studies												
4.3.1.1 Permeation of clean and oxidized metals	14	22	8	4	4							
4.3.1.2 Stability of oxides in steam systems	2				30	150	50	10	5			
Subtotal 4.3.1	16	22	8	4	34	150	50	10	5			
4.3.2 Solubility of tritium-containing species in molten salts												
4.3.2.1 Solubility of tritium in fuel salt			10	8	5	3						
4.3.2.2 Solubility of tritium in coolant salt							3	3	2	2		
4.3.2.3 Solubility of tritium fluoride in fuel salt							12	5	2			
Subtotal 4.3.2			10	8	5	3	15	8	4	2		
4.3.3 Equilibria between important species containing tritium in salt-gas systems												
4.3.3.1 Fuel salt equilibria				4	2	2						
4.3.3.2 Coolant salt equilibria					4	2	2	2				
Subtotal 4.3.3				4	6	4	2	2				
4.3.4 Isotopic exchange between tritium and chemically bound hydrogen							15					

Table 5.6.3.2 (continued)

	Fiscal year											
	1975	1976	1977	1978	1979	1980	1981	1982	1983	1984	1985	1986
4.3.5 TF corrosion behavior at low TF activity									4	2		
4.3.6 Diffusivity studies												
4.3.6.1 Diffusivity of HT and H ₂ in fuel salt								15	5			
4.3.6.2 Diffusivity of tritium in coolant salt									5	5		
4.3.6.3 Diffusivity of HF and TF in fuel salt										8	2	
4.3.6.4 Diffusivity of HF and TF in coolant salt									2	2	2	
Subtotal 4.3.6								15	12	15	4	
Total	16	22	18	16	45	157	82	35	25	19	4	

5.6.5 Task 4.3.1 Permeation studies

5.6.5.1 Subtask 4.3.1.1 Permeation of clean and oxidized metals

Measurements will be made of the rate at which tritium permeates candidate structural and steam generator materials in contact with gas of controlled dewpoint and hydrogen content. Precise measurements will be made using tritium as permeant in the presence of an excess of hydrogen in order to minimize transient and wall effects.

Studies will be carried out to determine the range of alloy compositions which will form useful tritium permeation barriers on potential steam generator materials when oxidized by supercritical steam. Initial work will include the construction of the appropriate apparatus and, then, measuring permeation through clean structural alloys, and through candidate steam generator alloys using steam having a dewpoint below 100°C. Oxides obtained on the potentially useful materials will be analyzed by Auger and ESCA methods and compared with oxides formed with other time-temperature histories. These latter oxides would be prepared in a separate facility - an oxidation test stand. Subsequent work in this subtask will involve additional screening tests for candidate steam generator materials and determination of long-term changes in oxide composition and structure.

5.6.5.2 Subtask 4.3.1.2 Stability of oxides in steam systems

Work in this subtask is concerned with determination of the chemical form, stability, and long-term effectiveness in retarding tritium permeation of oxide films formed on potential steam generator materials in the presence of high-pressure steam. Since the characteristics of corrosion oxide films formed in the boiler and superheater regions may differ, two test devices of small scale (4-cm-diam x 70-cm-long) will be constructed and operated with continuous monitoring of the tritium permeation. Both cool-down and heatup cycles of the boiler will be used to simulate thermal transients expected in MSBR steam systems. The test barrier oxides will be subjected to a variety of operating conditions.

If it is shown that oxide films are stable on candidate steam generator materials and that the oxides provide a significance resistance to tritium permeation, determination of the role of steam chemistry on the oxide formation and effectiveness will be needed. A larger-scale (10-cm-diam x 200-cm-long) pumped-loop facility would be used for studies in which the steam composition would be varied to provide information on the tolerance of the oxide to changes in chemical environment expected in a supercritical steam system.

5.6.6 Task 4.3.2 Solubility of tritium-containing species in molten salts

5.6.6.1 Subtask 4.3.2.1 Solubility of tritium in fuel salt

This subtask is related closely to Task 4.3.6, since both solubility and diffusivity are involved in transport of tritium to sparge gas bubbles or graphite and heat exchanger tube surfaces. The purpose of this subtask is to measure tritium solubility in fuel salt.

This measurement for hydrogen has proven to be difficult in the past,^{41,88,89} principally because of leakage and permeation of the hydrogen from the apparatus coupled with the very small quantities of tritium used in the measurements. However, in the presence of an excess of hydrogen, tritium permeates metals at a lower rate and also can be detected with great sensitivity. A mixed-isotope method should therefore be useful in determining tritium solubility. The high sensitivity with which tritium can be detected will also permit saturation of the salt to occur without using gas bubbles, which can complicate the interpretation of the data. Using a large area of thin-wall tubing, tritium can be introduced by permeation into a salt already saturated with protium. A second tubing section also having a large area would serve to carry permeated tritium to a tritium detector. The delay time between the introduction and detection of the tritium will be a direct measure of the capacity of the salt for dissolved tritium. This method is analogous to methods used to measure hydrogen solubility in refractory metals.

5.6.6.2 Subtask 4.3.2.2 Solubility of tritium in coolant salt

The determination of tritium solubility in coolant salt will be made in the apparatus used in Subtask 4.3.2.1. Since chemically bound isotopes may be present in $\text{NaBF}_4\text{-NaF}$, additional planning based on results from Task 4.3.4 will be required before this work is initiated.

5.6.6.3 Subtask 4.3.2.3 Solubility of tritium fluoride in fuel salt

The principal problems associated with the measurement of tritium fluoride solubility in fuel salt are the chemical interaction with UF_3 and the difficulty in obtaining saturation conditions. These problems probably can be overcome by using a HF-H_2 mixture of appropriately chosen composition to maintain constant oxidation conditions. This mixture would be recirculated through a quantity of salt and replenished at a low rate. The transient behavior on adding tritium would be related to the TF and T_2 solubilities. By appropriate choice of relative and total pressures, salt compositions, container material and the scale of the apparatus, a wide range of parameters relating to TF solubilities would be studied.

5.6.7 Task 4.3.3 Equilibria between important species containing tritium in salt-gas systems

The motivations for studying these equilibria are to obtain methods for preventing tritium, which is generated in the core, from reaching the steam system of the reactor. There are basically three chemical interactions for "trapping" tritium:

- (a) oxidation of molecular or atomic tritium; the oxidized tritium is then chemically bound in a species that does not permeate hot metals,
- (b) isotope exchange with hydrogen (mass number 1); for instance, $\text{TH} + \text{OH}^- = \text{OT}^- + \text{H}_2$,
- (c) sorption onto graphite or carbon; in the reactor core, sorption of tritium on graphite is helpful but insufficient for preventing excessive release of tritium into the coolant circuit.

5.6.7.1 Subtask 4.3.3.1 Fuel salt equilibria

In the fuel salt, the oxidizing conditions are governed by the $\text{U}^{4+}/\text{U}^{3+}$ ratio; this ratio will be fixed at about 100 by the need to prevent corrosion of chromium, formation of uranium carbide, and oxidation of the protactinium (see Section 5.4.10). Since strongly oxidizing conditions, i.e. $\text{U}^{4+}/\text{U}^{3+}$ ratios greater than 1000, appear to be necessary to convert all the elemental tritium to tritium fluoride, it is likely that both T_2 and TF will be present in the fuel salt. The TF/ T_2 ratio will be determined as a function of the $\text{U}^{4+}/\text{U}^{3+}$ ratio. Mixtures of TF and T_2 will be bubbled through molten fuel salt at constant temperature and the resulting $\text{U}^{4+}/\text{U}^{3+}$ ratios will be measured spectrophotometrically.

5.6.7.2 Subtask 4.3.3.2 Coolant salt equilibria

From previous measurements³⁵ and from on-going studies (5.5.6.1, Subtask 4.2.2.1) oxidation equilibria of tritium in fluoroborate coolant can be calculated. However, we do not know the solubility of TF in the coolant. The solubility values determined under 5.6.6.2, Subtask 4.3.2.2, will be complemented by study of the equilibrium

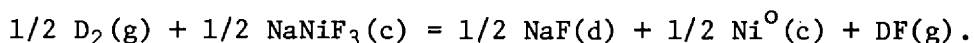

In this study, known amounts of deuterium diffusing into a nickel capsule containing NaNiF_3 and NaBF_4 -NaF (92-8 mole %) will be measured. The same experiment will then be applied to other oxidants (e.g., Na_3CrF_6) and, perhaps, to alternate coolants.

5.6.8 Task 4.3.4 Isotopic exchange between tritium and chemically bound hydrogen

Although previous attempts⁹⁰ to exchange deuterium for protium in the species BF_3OH^- have not proved successful, it is by no means certain that isotope exchange reactions are not feasible in fluoroborate coolant. Capsule experiments similar to that described above (Subtask 4.3.3.2), will be performed to study the general reaction

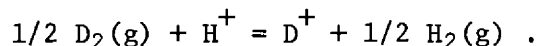

In these experiments, partial pressures will probably be monitored by mass spectroscopy.

5.6.9 Task 4.3.5 TF corrosion behavior at low TF activity

In the MSBR fuel salt, a large fraction of the tritium would be present as TF if the $\text{U}^{3+}/\text{U}^{4+}$ ratio were reduced to 0.001. A significant fraction of the tritium could therefore possibly be removed from the fuel salt as TF if the gas sparge rate were high enough and/or the rate of reaction of TF with the metal surfaces were very low.⁹¹ This subtask will determine the rates of reaction of HF (or TF) with Hastelloy N and similar alloys under conditions of low HF (or TF) activity. Since TF can probably be used in this work, corrosion rates can be determined by measuring the rate of release of T_2 .

5.6.10 Task 4.3.6 Diffusivity studies

5.6.10.1 Subtask 4.3.6.1 Diffusivity of HT and H₂ in fuel salt

A time-lag permeation method will be employed using deuterium permeation coupled with an ultra-high vacuum system mass-spectrometer detection method to determine both the solubility and the diffusivity of deuterium (initially used as a stand-in for HT and as a calibrating gas) in the salt. After ascertaining that there is adequate agreement with the independently measured values of solubility of tritium, Task 4.3.2, the equipment will be modified for a determination with tritium.

5.6.10.2 Subtask 4.3.6.2 Diffusivity of tritium in coolant salt

Substantially the same approach and equipment used in Subtask 4.3.6.1 will be employed.

5.6.10.3 Subtask 4.3.6.3 Diffusivity of HF and TF in fuel salt

An electrochemical method is expected to be applicable to the determination of diffusion constants of hydrogen ions in fuel salt. With adequate solubility of hydrogen fluoride (Subtask 4.3.2.3), the sensitivity of the electrochemical method should permit a relatively straightforward determination as a function of temperature and composition.

5.6.10.4 Subtask 4.3.6.4 Diffusivity of HF and TF in coolant salt

Following the completion of Subtask 4.3.6.3, a study of coolant salts would be undertaken using the same method and equipment.

5.6.11 Task 4.3.7 Modeling of tritium behavior in molten-salt reactors

The data on tritium reactions, solubilities, diffusivities, and permeation obtained in the other tasks of Task Group 4.3 are needed to assess the distribution of tritium in molten-salt reactors. This task is directed toward mathematical modeling of the flow and processing of tritium in the reactor. The approach taken in this task would be similar to that of Briggs and Korsmeyer.⁹² Additions of process variables and the best new data as it is developed to the calculation would permit the necessary detailed exploration of options for control of tritium in molten-salt reactors. Work in this task interacts strongly with reactor design and analysis (Section 8) and reactor technology development (Section 10).

5.6.12 Task 4.3.8 Tritium adsorption on carbon in contact with the coolant

Some of the tritium generated by the MSRE was found within the graphite moderator.³⁸ Although a similar situation in an MSBR will be helpful, it is not likely to prevent excessive amounts of tritium from diffusing into the coolant. However, it is possible that graphite (or carbon) in contact with the coolant could adsorb a large fraction of the tritium. Initial studies have shown that the capacity of carbon for tritium might be adequate (~ 10 Ci of T_2 per kg of carbon), but that kinetics may be inadequate to permit high removal efficiency. A catalytic effect of very thin nickel coatings in enhancing the kinetics would be expected by analogy with many industrial catalytic processes. This subtask would be directed toward the preparation and testing of nickel coatings, and determining the feasibility of this approach for removing tritium from the coolant.

5.7 TASK GROUP 4.4 FISSION PRODUCT CHEMISTRY

5.7.1 Objective

Emphasis will be placed on clarifying the behavior of the noble metal fission products with particular attention focused on identifying actual species (metallic or otherwise) which occur at defined redox conditions. Subsequent studies will be aimed at characterizing those factors which affect the transport behavior of these species in MSBR systems. Although previous data have indicated that these fission products were present as reduced metals in the MSRE, the redox chemistry of those most susceptible to oxidation (e.g., Nb and Mo) should be examined as a function of U^{4+}/U^{3+} ratio and oxide ion concentration to verify these former conclusions. This information will be useful in predicting the amount and nature of these elements entering the fuel processing system.

Other fission products will be investigated for the purposes of evaluating alternate xenon-control schemes (such as hydrofluorination of I^-) and developing structural component decontamination procedures. Finally, in view of new information, a re-examination of the MSRE data may prove fruitful in predicting effects from parameter variations during MSBR operations.

5.7.2 Schedule

The schedule for work in this task group is shown in Table 5.7.2.

5.7.3 Funding

The operating fund requirements for this task group are given in Table 5.7.3.1, and the capital equipment fund requirements are given in Table 5.7.3.2.

5.7.4 Facilities

No new major facilities will be required for this task.

5.7.5 Task 4.4.1 Noble metal chemistry

It is essential that the understanding of noble-metal behavior be increased to a level comparable to that of the other fission products. A wealth of fundamental chemical property and thermodynamic data exists for fission products other than the noble metals. For example, their oxidation states have been characterized and can be accurately predicted based on available free energies of formation both in solution and in pure compounds. The noble metals can exist in several oxidation states

Table 5.7.2. Schedule for work in Task Group 4.4 - Fission product chemistry

	Fiscal year											
	1975	1976	1977	1978	1979	1980	1981	1982	1983	1984	1985	
4.4.1 Noble metal chemistry												
4.4.1.1 Redox chemistry as a function of U^{4+}/U^{3+} ratio												
4.4.1.2 Reactions with oxide ion												
4.4.1.3 Reactions with graphite												
4.4.1.4 Noble metal agglomeration and deposition												
4.4.1.5 Distribution of noble metals between molten salt and He												
4.4.2 Iodine distribution												
4.4.3 Decontamination of Hastelloy N												
4.4.4 Analysis of fission product deposition data from MSRE												
4.4.5 Studies in the Gas-System Technology Facility (GSTF)												

Table 5.7.3.1. Operating fund requirements for Task Group 4.4 - Fission product chemistry
(costs in 1000 dollars)

	Fiscal year										
	1975	1976	1977	1978	1979	1980	1981	1982	1983	1984	1985
4.4.1 Noble metal chemistry											
4.4.1.1 Redox chemistry as a function of U ⁴⁺ /U ³⁺ ratio		25	55	30	30	30					
4.4.1.2 Reactions with oxide ion		25	25	55	55	55					
4.4.1.3 Reactions with graphite		25	30	55	55						
4.4.1.4 Noble metal agglomeration and deposition				25	74	75	75	55	25	25	
4.4.1.5 Distribution of noble metals between molten salt and He						39	65	55	55		
Subtotal 4.4.1		75	110	165	214	199	140	110	80	25	
4.4.2 Iodine distribution						55	75	55	55		
4.4.3 Decontamination of Hastelloy N								25	55		
4.4.4 Analysis of fission product deposition data from MSRE							10				
4.4.5 Studies in the gas system technology facility							25	55	25		
Total operating funds for Task Group 4.4		75	110	165	214	254	250	245	215	25	

Table 5.7.3.2. Capital equipment fund requirements for Task Group 4.4 - Fission product chemistry
(costs in 1000 dollars)

	Fiscal year										
	1975	1976	1977	1978	1979	1980	1981	1982	1983	1984	1985
4.4.1 Noble metal chemistry											
4.4.1.1 Redox chemistry as a function of U^{4+}/U^{3+} ratio		10	10	20							
4.4.1.2 Reactions with oxide ion		10	5	15							
4.4.1.3 Reactions with graphite			15	5							
4.4.1.4 Noble metal agglomeration and deposition				5	5	75					
4.4.1.5 Distribution of noble metals between molten salt and He						10	25	5			
Subtotal 4.4.1		20	30	45	5	85	25	5			
4.4.2 Iodine distribution						35	2				
4.4.3 Decontamination of Hastelloy N								5	2		
4.4.5 Studies in the Gas-System Technology Facility (GSTF)							10				
Total capital equipment funds for Task Group 4.4		20	30	45	5	120	37	10	2		

(cf. Ref. 93 for a description of possible valences and compounds for niobium halides) while often forming species with unusual chemical bonds (e.g., metal-metal bonded complexes) but details concerning their stability are not available.

Realizing that the fission products are formed in the reactor as highly charged species which must rapidly acquire electrons, it is plausible that some of these oxidation states may play key roles in the behavior of the noble fission products as they progress toward the metallic state. Such reduction processes may determine the ultimate particle size and distribution found in the reduced state and should be examined.

5.7.5.1 Subtask 4.4.1.1 Redox chemistry as a function of U^{4+}/U^{3+} ratio

First in the study of the noble metal redox chemistry will be a determination of the possible oxidation states and the nature of the species which these elements form in molten fluoride solution. Spectroscopic and electrochemical techniques will be used, but will require concentrations of fission products several orders of magnitude greater than those anticipated in an MSBR. These studies would nevertheless identify those states which might merit further study.

Having identified the stable soluble species of these fission products, experiments involving equilibration of these species under controlled redox potentials would be made to determine their thermodynamic stability. Standard procedures involving HF-H₂ gas mixtures or U^{4+}/U^{3+} solutions will be used and will be accompanied by electrochemical or spectrophotometric monitoring of the soluble species.

The noble metals will be studied in order of importance based on their susceptibility to oxidation, their fission yield and their neutron cross sections. Because niobium is the most easily oxidized,¹ it will receive the greatest attention. Molybdenum and the remaining noble metal fission product elements will be studied as the work progresses.

It is presently known that niobium can exist in the 5+ and 4+ oxidation states in fluoride solution.⁹⁴⁻⁹⁷ When Nb^{4+} is reduced still further in solution, lower oxidation states have been indicated but have not been well characterized.⁹⁴ The 3+ and 2.5+ states are known in pure halide compounds,⁹³ and could possibly occur in fluoride solutions. The results of Weaver et al.⁹⁶ have not, however, indicated any valences less than 4+ in molten LiF-BeF₂ (66-34 mole %).

Molybdenum is known to exist in the 6+, 5+, 4+ and 3+ states,⁹⁸ with the 3+ state being identified in molten fluoride solutions.⁹⁹ Lower valences have not been reported in fluoride melts.

Solutions of Nb^{4+} and Mo^{3+} will be prepared and reduced by equilibration with their respective metals and eventually with the other redox mixtures mentioned above. Species of lower valence and with unusual bonding

properties will be sought to determine if they can occur as kinetically unreactive intermediates. These experiments are expected to clarify many of the mechanisms and rates which have been presumed to occur under operating reactor conditions.

5.7.5.2 Subtask 4.4.1.2 Reactions with oxide ion

The redox chemistry of noble metals in MSBR fuels may be complicated by reactions involving trace concentrations of oxide. Oxide may cause formation of oxyions and precipitation of sparingly soluble oxides in which the valence of the metallic element is higher than would be stable at the same U^{3+}/U^{4+} ratio in the absence of oxide. Hence, the amount of noble metal that can enter solution as an ionic species or be converted to a solid oxide depends on the oxide concentration as well as the redox potential.

A recent study¹⁰⁰ has revealed that Nb^{5+} forms the very stable oxyion NbO_2^+ in molten fluorides, rendering the pentavalent state more stable in solution and the oxide Nb_2O_5 more soluble than would otherwise be the case. The object of this subtask is to conduct similar studies of the chemistry of molybdenum and ruthenium in molten fluorides in order to define the behavior of these noble-metal fission products in an MSBR fuel.

In the absence of oxide, molybdenum apparently¹⁰¹ can be oxidized from the metal to the trivalent state in molten fluorides at a redox potential intermediate between that required to oxidize Fe^0 to Fe^{2+} and Ni^0 to Ni^{2+} . In the presence of oxide, oxidation should lead to the formation of very insoluble MoO_2 ; however, from available formation free energies, the reaction

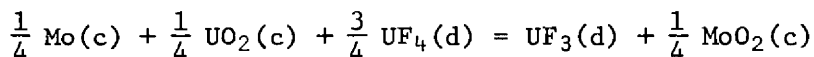

should not proceed until the U^{3+}/U^{4+} ratio falls to $<10^{-5}$. Yet, the Mo^{4+} ion is smaller than Zr^{4+} ion (0.69 vs 0.79 Å), which has a slight tendency to form an oxyion. Formation of an oxyion of Mo^{4+} sufficiently stable to persist at the low oxide concentration of an MSBR fuel is a distinct possibility that should be investigated.

A similar study would be undertaken for ruthenium which is expected to be more noble than molybdenum. The fluoride formed on oxidation of the metal is expected to be RuF_3 , while the stable oxide is probably RuO_2 , though its formation by a reaction analogous to the one above for molybdenum should occur at much lower U^{3+}/U^{4+} ratios ($\sim 10^{-9}$). The ion size of Ru^{4+} is somewhat smaller than Mo^{4+} ; hence, oxyions in solution are again a possibility.

5.7.5.3 Subtask 4.4.1.3 Reactions with graphite

Molybdenum can form Mo_2C and MoC at MSBR operating temperatures. The free energies of formation of these compounds become negative at 450°C and the compounds become more stable at increasing temperatures.¹⁰² Niobium likewise forms two carbides Nb_2C and NbC ¹⁰³ with negative free energies of formation (< -20 kcal/mole) and would be stable at MSBR operating temperatures. Nothing appears to be known concerning the carbides of technetium, but it seems certain that no carbide formation is expected from the platinum metals, Ag, Te, Cd, Sb, and Sn.¹

Experiments will be conducted with dilute solutions of potential carbon-seeking fission products in graphite containers under various redox conditions. It will be determined whether carbide formation does occur and what factors govern it at typical MSBR operating conditions. Identification of the carbide phases will be made by x-ray analysis and the soluble (partially oxidized) species giving rise to the carbides will be followed by electrochemical and/or spectrophotometric means.

5.7.5.4 Subtask 4.4.1.4 Noble-metal agglomeration and deposition

The noble metals, molybdenum, ruthenium, etc., are formed atomically in the fuel of a molten-salt reactor. Consequently, their fate in the reactor depends on the kinetics of their agglomeration and deposition. These phenomena are in turn expected to be dependent on the flow rates of the liquid, the chemical environment of the atoms, their diffusivities, and nature of the surfaces available for deposition.

The objective of this subtask is to define the significant parameters which would permit estimates to be made of the fates of the noble-metal elements.

The experimental approach to be followed initially will use nonradioactive materials and would make use of the high sensitivity ($\sim 10^{10}$ atoms) of Auger analysis. Exploding wire methods and chemical decompositions would be attempted to prepare fine dispersions in flowing molten salt. The deposition of these materials onto graphite and metals would be characterized. Subsequent experiments would use tracer methods and in-pile fission experiments to correlate the earlier results and to develop a basis for the monitoring methods required for a reactor. During the deposition studies, attempts to study agglomeration rates would be made under conditions of very low flow rates.

5.7.5.5 Subtask 4.4.1.5 Distribution of noble metals between molten salt and He

The use of techniques developed under Subtask 4.4.1.4 would be extended to conditions of high flow in the presence of a dispersion of helium. Both the agglomeration rate and the deposition process are expected to vary from the patterns observed in the absence of helium. The helium

would be removed from the salt into a flowing gas stream of additional helium which would be conducted into a deposition region in which the gas with entrained noble metals would move with variable velocity across test specimens or through filters. Auger analysis would be used to characterize the deposits.

The size of the helium bubbles would be a strong variable in this study and would be the principal independent variable in the work of this sub-task. If adequate correlation is developed under Subtask 4.4.1.4 between out-of-pile and in-pile deposition in the absence of helium, in-pile studies under the present subtask would not be required.

5.7.6 Task 4.4.2 Iodine distribution

The behavior of iodine and its removal from molten mixtures of LiF-BeF₂ has been studied because of its relevance to the problem of ¹³⁵Xe removal from MSBRs and to the containment necessary during maintenance operations. It has been considered that, under the normal operating conditions of a molten-salt reactor ($X_{UF_3} / X_{UF_4} \approx 0.01$), iodine is present in solution in its most reduced state, i.e., as I⁻. Thus, its removal from molten fluoride solution has been studied by means of transpiration experiments using HF-H₂ mixtures as the sparging gas. Although the reaction studied

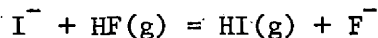

is metathetical, hydrogen was present to prevent corrosion of the metallic container and to suppress dissociation of the HI. The data obtained indicated that quantitative removal of HI, and thus of a significant fraction of Xe, can be accomplished and that the rate-controlling step of the reaction is the transport of I⁻ from the bulk of the melt to the surface.^{76,104} Since the concentration of ¹³⁵I in an MSBR has been estimated to be about 20,000 times lower than in the laboratory experiments and since MSBR fuel is a more complex redox system than the solvent studied, additional research is required in order to test many of the assumptions and calculations made and to further evaluate this method for removing iodine from the reactor. Control of ¹³⁵Xe poisoning in an MSBR via iodine removal would require the simultaneous removal of ¹³⁵Xe since the direct fission yield of ¹³⁵Xe is 18%.

5.7.7 Task 4.4.3 Decontamination of Hastelloy N

The maintenance of some parts of an MSBR may necessitate the decontamination of moderately contaminated equipment. It is anticipated that surface decontamination of Hastelloy N will not be appreciably different than other metals for which there is a long history of experience. Experiments to investigate decontamination will be carried out to define practical operating procedures.

5.7.8 Task 4.4.4 Analysis of fission product deposition data from MSRE

The experience with the MSRE showed that the noble gases and stable fluorides behaved as expected based on their chemistry. The noble metal behavior and fates,¹⁰⁵ however, are still in part a matter of conjecture. Except for niobium under unusual oxidizing conditions, it seems clear that these elements are present as metals and that their ubiquitous properties stem from the fact that the metals are not wetted by, and have extremely low solubilities in, MSR fuels. Unfortunately, the MSRE observations probably were substantially affected by the spray system, oil cracking products, and flow to and from the overflow, all of which were continuously changing, uncontrolled variables. The low material balance on ¹³¹I indicates appreciable undetermined loss from the MSRE; probably as a noble metal precursor (Te, Sb).

Table 5.3.3.4 shows the estimated distribution of the various fission products in a molten-salt reactor based on the MSRE studies. Unfortunately, the wide variance and poor material balances for the noble metal data make it unrealistic to specify their fates more than qualitatively. As a consequence, future reactor designs must allow for encountering appreciable fractions of the noble metals in a number of regions of the reactor. As indicated in the table, continuous chemical processing and the processes finally chosen will substantially affect the fates of many of the fission products.

5.7.9 Task 4.4.5 Studies in the Gas-System Technology Facility (GSTF)

Noble metal behavior in the MSRE was most difficult to determine and, therefore, will be difficult to predict in an MSBR. The noble metals are born as atomic fission products and are insoluble in the fuel salt. The atomic-size particles are not wet by the fuel salt and tend to agglomerate, presumably as a dust or scum on the salt surface and as a deposit on the Hastelloy N surfaces. It may be possible to design experiments utilizing the Gas-System Technology Facility (GSTF)¹⁰⁶ to investigate metal mist distribution between the salt and gas stream as a function of time, salt flow rate, temperature, and stripper gas void volume. The metal mist could possibly be generated by exploding-wire techniques to simulate formation of the atomic-size fission products.

5.8 TASK GROUP 4.5 FUNDAMENTAL STUDIES OF MOLTEN SALTS

5.8.1 Objective

Any chemical reaction that is thermodynamically favored can be expected to occur in an MSBR fuel environment. Kinetic barriers seldom prevent such favored reactions from proceeding. As a consequence, thermodynamic data for MSBR-related molten fluoride mixtures provide an extremely useful means for predicting the extent of chemical reactions in such systems and the accumulation of thermochemical data for actinide, fission product, and structural metal fluorides from the measurement of selected chemical equilibria has been an important part of the basic chemical development effort which has supported the MSBR program at ORNL.⁴⁹⁻⁵¹ The objective of this task group is to accumulate formation free energies and activity coefficient values for all important substances present in the fuel with sufficient accuracy to define the course of all relevant chemical reactions over the ranges of temperature and salt composition that can occur in an MSBR. Because of the transcendent nature of thermodynamics, it is possible to achieve this ambitious goal through continued judicious choices of chemical equilibria for measurement.

Parts per million concentrations of various chemical species (e.g., oxygen, tellurium, bismuth) can profoundly affect molten salt reactor systems. Porous electrodes have provided an excellent means of monitoring and eliminating similar low-level impurities in aqueous systems and work will be directed at developing techniques and equipment for use in molten salts.

5.8.2 Schedule

The schedule for work in this task group is shown in Table 5.8.2.

5.8.3 Funding

The operating fund requirements for this task group are summarized in Table 5.8.3.1, and the capital equipment fund requirements are summarized in Table 5.8.3.2.

5.8.4 Facilities

No special facilities will be required. Existing chemical laboratory space is adequate for this research.

Table 5.8.2. Schedule for work in Task Group 4.5 - Fundamental studies of molten salts

	Fiscal year					
	1975	1976	1977	1978	1979	1980
4.5.1 Free energy of formation determinations						
4.5.2 Porous electrode studies						

Table 5.8.3.1. Operating fund requirements for Task Group 4.5 - Fundamental studies of molten salts (costs in 1000 dollars)

	Fiscal year					
	1975	1976	1977	1978	1979	1980
4.5.1 Free energy of formation determinations	85	145	85			
4.5.2 Porous electrode studies	55	55	165	200	140	
Total operating funds for Task Group 4.5	140	200	250	200	140	

Table 5.8.3.2. Capital equipment fund requirements for Task Group 4.5 - Fundamental studies of molten salts (costs in 1000 dollars)

	Fiscal year					
	1975	1976	1977	1978	1979	1980
4.5.1 Free energy of formation determinations	10	3	5			
4.5.2 Porous electrode studies	6	2	25	50	10	
Total capital equipment funds for Task Group 4.5	16	5	30	50	10	

5.8.5 Task 4.5.1 Formation-free energy and activity coefficient determinations

Measurements will first be made of the following equilibrium in LiF - BeF₂ - ThF₄ melts as a function of melt composition and temperature:

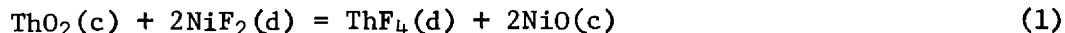

The variation of the corresponding equilibrium quotient

$$Q_1 = \frac{X_{\text{ThF}_4}}{X_{\text{NiF}_2}^2}$$

with melt composition should reflect changes in the activity coefficients γ_{NiF_2} and γ_{ThF_4} , as shown,

$$Q_1 = K_1 \frac{\gamma_{\text{NiF}_2}^2}{\gamma_{\text{ThF}_4}}$$

Here K_1 is the equilibrium constant, defined equal to Q in Li₂BeF₄. From the value of K_1 , the free energy change for reaction (1), ΔG_1 , is obtained from

$$-RT \ln K_1 = \Delta G_1 = \Delta G_{\text{ThF}_4(\text{d})}^{\text{f}} + 2 \Delta G_{\text{NiO}(\text{c})}^{\text{f}} - \Delta G_{\text{NiF}_2(\text{d})}^{\text{f}} - \Delta G_{\text{ThO}_2}^{\text{f}} \quad (2)$$

The formation-free energies of the oxides, $\Delta G_{\text{NiO}}^{\text{f}}$ and $\Delta G_{\text{ThO}_2}^{\text{f}}$, are quite well known, as is that for NiF₂ in Li₂BeF₄ [$\Delta G_{\text{NiF}_2(\text{d})}^{\text{f}}$]. Hence, an improved value of the formation-free energy of ThF₄ in Li₂BeF₄ can be obtained from ΔG_1 .

The activity coefficient of NiF₂ in the fuel mixture will be derived from a measurement of the solubility of NiF₂,

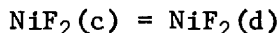

where K_2 , the solubility in Li₂BeF₄, is

$$K_2 = X_{\text{NiF}_2} \gamma_{\text{NiF}_2}$$

From γ_{NiF_2} and the quotient $\frac{\gamma_{\text{NiF}_2}^2}{\gamma_{\text{ThF}_4}}$, obtained from Q_1 in the same

LiF-BeF₂-ThF₄ salt mixture, the activity coefficient of ThF₄ in this fuel salt mixture can then be obtained.

In subsequent studies, other equilibria of the following general type will be measured

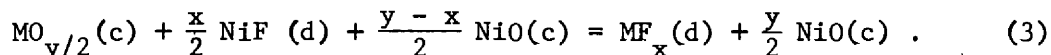

Here the valence of the metal M in the fluoride (x) can be less than or equal to that in the metal oxide (y). The MF_x - MO_{y/2} combinations that will be considered for study include: UF₄-UO₂; ZrF₄-ZrO₂; TiF₃-TiO₂; FeF₂-Fe₂O₃; CrF₂ - Cr₂O₃. From the corresponding equilibrium quotients

$$Q_3 = \frac{X_{MF_x}}{X_{NiF}^{x/2}} = K_3 \frac{\gamma_{NiF_2}^{x/2}}{\gamma_{MF_y}}$$

the formation free energy $\Delta G_{MF_x}^f$ and the activity coefficient γ_{MF_x} of the metal fluoride may be derived.

As data on activity coefficients effects are accumulated, it is planned to improve the correlation of these with melt composition, cation size, and cation charge. The goal is to computerize this information, along with an updated tabulation of formation free energies, in a form convenient for those who wish to estimate the various chemical equilibria in MSBR fuels.

5.8.6 Task 4.5.2 Porous electrode studies

Monitoring and/or removal of low concentration species such as O, Te, and Bi in molten salt fuels is essential to the satisfactory and safe operation of molten-salt breeder reactors. Initial investigation of the possible use of porous electrodes in molten-salt fuels are directed at identification of materials and design of a suitable cell and auxiliary equipment for conducting investigations in fluoride melts. This equipment will be used to investigate the problem of monitoring and/or removal of bismuth from the return stream from the chemical processing operations.¹⁰⁷ Data to be obtained include total current requirement, Faradaic efficiency, and potential drop through the porous or packed-bed electrode as a function of electrode potential, salt flow rate, temperature, and the concentration and identity of the bismuth species. This information will allow the establishment of the feasibility of using a porous electrode as a bismuth monitor or as a device for efficient removal of bismuth from a flowing MSBR salt stream.

REFERENCES FOR SECTION 5

1. W. R. Grimes, E. G. Bohlman, A. S. Meyer and J. M. Dale, *The Development Status of Molten-Salt Breeder Reactors*, ORNL-4812 (August 1972), pp. 95-167.
2. S. Cantor, *Molten-Salt Reactor Program Monthly Report for June 1974*, MSR-74-52, pp. 7-9.
3. H. T. Kerr and A. M. Perry, *Tritium Production in MSBR's*, MSR-69-116 (Dec. 3, 1969).
4. Roy C. Robertson, *Conceptual Design Study of a Single-Fluid Molten-Salt Breeder Reactor*, ORNL-4541 (June 1971).
5. P. N. Haubenreich, *The Development Status of Molten-Salt Breeder Reactors*, ORNL-4812 (August 1972), pp. 33-49.
6. R. E. Thoma, *Chemical Aspects of MSRE Operation*, ORNL-4658 (December 1971).
7. R. C. Robertson, *Estimated Cost of Adding a Third Salt-Circulating System for Controlling Tritium Migration in the 1000-MW(e) MSBR*, ORNL-TM-3428 (July 1971).
8. R. E. Thoma (ed.), *Phase Diagrams of Nuclear Materials*, ORNL-2548 (Nov. 6, 1959).
9. K. A. Romberger, J. Braunstein and R. E. Thoma, *J. Phys. Chem.* 76: 1154 (1972).
10. R. E. Thoma et al., *J. Phys. Chem.* 64: 865 (1960).
11. C. F. Baes, Jr., J. H. Shaffer and H. F. McDuffie, *Trans. Am. Nucl. Soc.* 6: 393 (1963).
12. K. A. Romberger, C. F. Baes, Jr. and H. H. Stone, *J. Inorg. Nucl. Chem.* 29: 1619 (1967).
13. C. E. Bamberger and C. F. Baes, Jr., *J. Nucl. Mat.* 35: 177 (1970).
14. D. D. Sood, *Engineering Studies on Reductive Extraction and Oxide Precipitation Techniques for Processing Molten Salt Reactor Fuels*, ORNL-CF-72-5-32 (May 1972).
15. C. E. Bamberger, R. G. Ross and C. F. Baes, Jr., *J. Inorg. Nucl. Chem.* 33: 767 (1971).
16. C. E. Bamberger, R. G. Ross and C. F. Baes, Jr., *National Bureau of Standards Special Publication 364. Solid State Chemistry, Proceedings of 5th Materials Research Symposium*, p. 331 (1972).

17. C. F. Baes, Jr., *MSR Program Semiannu. Progr. Rept. for Period Ending Feb. 29, 1972*, ORNL-4782 (Oct. 1972), p. 74.
18. W. R. Grimes, *Nucl. Applic. Technol.* 8: 137 (1970).
19. R. G. Ross, C. E. Bamberger and C. F. Baes, Jr., *J. Inorg. Nucl. Chem.* 35: 433 (1973).
20. O. K. Tallent and L. M. Ferris, *J. Inorg. Nucl. Chem.* 36: 1277 (1974)
21. H. E. McCoy, *The Development Status of Molten-Salt Breeder Reactors*, ORNL-4812 (August 1972), pp. 195-220.
22. C. E. Bamberger, J. P. Young and R. G. Ross, *J. Inorg. Nucl. Chem.* 36: 1158 (1974).
23. R. E. Thoma, *Chemical Feasibility of Fueling Molten Salt Reactors with PuF_3* , ORNL-TM-2256 (October 1968).
24. C. E. Bamberger, R. G. Ross, C. F. Baes, Jr. and J. P. Young, *J. Inorg. Nucl. Chem.* 33: 3591 (1971).
25. *Molten Salt Breeder Reactor Concept, Quarterly Rept. for Period Ending July 31, 1971*, NP-19145 (Atomic Energy Commission, Bombay, India).
26. C. E. Bamberger, C. F. Baes, Jr., J. P. Young and C. S. Sherer, *MSR Program Semiannu. Progr. Rept. Feb. 20, 1968*, ORNL-4254, pp. 171-73.
27. H. F. McDuffie et al., *Assessment of Molten Salts as Intermediate Coolants for LMFBR's*, ORNL-TM-2696 (Sept. 3, 1969), p. 20.
28. S. Cantor (ed.), *Physical Properties of Molten-Salt Reactor Fuel, Coolant and Flush Salts*, ORNL-TM-2316 (August 1968).
29. S. Cantor, *Density and Viscosity of Several Molten Fluoride Mixtures*, ORNL-TM-4308 (March 1973).
30. L. M. Toth and L. O. Gilpatrick, *The Equilibrium of Dilute UF_3 Solutions Contained in Graphite*, ORNL-TM-4056 (December 1972).
31. R. B. Briggs, J. R. Engel, and P. N. Haubenreich, *The Development Status of Molten-Salt Breeder Reactors*, ORNL-4812 (August 1972), pp. 389-416.
32. J. W. Cooke, *MSR Program Semiannu. Progr. Rept. Aug. 31, 1969*, ORNL-4449, p. 92.
33. J. B. Bates, J. P. Young, M. M. Murray, H. W. Kohn and G. E. Boyd, *J. Inorg. Nucl. Chem.* 34: 2721 (1972).
34. C. J. Barton, *J. Inorg. Nucl. Chem.* 33: 1946 (1971).

35. C. E. Bamberger, B. F. Hitch and C. F. Baes, Jr., *J. Inorg. Nucl. Chem.* 36: 543 (1974).
36. S. Cantor, *J. Nucl. Mater.* 47: 177 (1973).
37. R. B. Briggs, *Reactor Technol.* 14: 335 (1971).
38. Code of Federal Regulations, Title 10, Part 50, Appendix I.
39. C. L. Weaver, E. D. Howard and H. T. Peterson, Jr., Public Health Rept. (U.S.) 84(4): 363-371 (April 1969).
40. R. A. Strehlow and H. C. Savage, *Nucl. Technol.* 22: 127 (1974).
41. A. P. Malinauskas and D. M. Richardson, "The Solubilities of Hydrogen, Deuterium and Helium in Molten Li_2BeF_4 ," *Ind. Eng. Chem. Fund.* 13: 242 (1974).
42. G. Long and F. F. Blankenship, *The Stability of Uranium Trifluoride, Parts I and II*, ORNL-TM-2065 (1969).
43. R. A. Strehlow, *MSR Program Semiannu. Progr. Rept. for Period Ending Feb. 28, 1970*, ORNL-4548, p. 167.
44. W. R. Grimes, N. V. Smith and G. M. Wilson, *J. Phys. Chem.* 62: 862 (1958).
45. M. Blander, et al., *J. Phys. Chem.* 63: 1164 (1959).
46. G. M. Watson et al., *J. Chem. Eng. Data* 7: 285 (1962).
47. M. W. Rosenthal, P. N. Haubenreich and R. B. Briggs, *The Development Status of Molten-Salt Breeder Reactors*, ORNL-4812 (August 1972), p. 14.
48. Dunlap Scott et al., *The Development Status of Molten-Salt Breeder Reactors*, ORNL-4812 (August 1972), pp. 221-308.
49. C. F. Baes, Jr., *J. Nucl. Mater.* 51: 149 (1974).
50. C. F. Baes, Jr., in "Symposium on Processing of Nuclear Fuels," P. Chiotti (ed.), *Nuclear Metallurgy* 15: 617 (1969); USAEC-CONF-690801.
51. C. F. Baes, Jr., "The Chemistry and Thermodynamics of Molten Salt Fluoride Solutions," *Thermodynamics 1* (IAEA) Vienna 1966, p. 409.
52. L. M. Ferris, J. C. Mailen and F. J. Smith, *J. Inorg. Nucl. Chem.* 33: 1325 (1971).
53. L. M. Ferris, J. C. Mailen and F. J. Smith, *J. Inorg. Nucl. Chem.* 34: 491 (1972).

54. L. M. Ferris, *Inorg. Nucl. Chem. Letters* 7: 791 (1971).
55. F. A. Posey, *Electrolytic Demonstration Unit for Copper Removal from Distillation Plant Blowdown*, ORNL-TM-4112 (March 1973).
56. R. E. Meyer and F. A. Posey, *J. Electroanal. Chem. Interfacial Electrochem.* 49: 377-86 (1974).
57. D. D. Sood, W. R. Laing and C. E. Bamberger, *MSR Program Monthly Report for Period Ending April 30, 1972*, MSR-72-36 (May 1, 1972), p. 16.
58. H. R. Bronstein and D. L. Manning, *J. Electrochem. Soc.* 119: 125 (1972).
59. R. G. Ross and C. E. Bamberger, personal communication.
60. A. L. Mathews and C. F. Baes, Jr., *Inorg. Chem.* 7: 373 (1968).
61. C. W. Kee, personal communication.
62. J. P. Young, C. E. Bamberger and R. G. Ross, *J. Inorg. Nucl. Chem.* (in press).
63. P. T. Cunningham, S. A. Johnson and E. J. Cairns, *J. Electrochem. Soc.* 120: 328 (1973).
64. Letter from C. F. Baes and C. E. Bamberger to W. R. Grimes, July 11, 1972.
65. D. M. Gruen, R. L. McBeth, M. S. Foster and C. E. Crouthamel, *J. Phys. Chem.* 70: 472 (1966).
66. C. E. Bamberger, "Experimental Techniques in Molten Fluoride Chemistry," *Advances in Molten Salt Chemistry*, Plenum Press, Vol. 3 (in press).
67. W. Suski, *Phys. Stat. Solids A* 13: 675 (1972).
68. G. V. Ellert and V. K. Slovyanskikh, *Russ. J. Inorg. Chem.* 17: 303 (1972).
69. M. S. Foster and C. C. Liu, *J. Phys. Chem.* 70: 950 (1966).
70. J. H. Shaffer, personal communication.
71. ORNL Memo to C. F. Baes, Jr. from C. E. Bamberger and R. G. Ross, February 1, 1972.
72. D. M. Richardson and J. H. Shaffer, *MSRP Monthly Report for October 1969*, MSR-69-106, pp. 18-20.

73. A. N. Smith, *Experience with Sodium Fluoroborate Circulation in an MSRE-Scale Facility*, ORNL-TM-3344, pp. 103-05, September 1972.
74. J. W. Cooke, *MSR Program Semiannu. Progr. Rept. for Period Ending Aug. 31, 1969*, ORNL-4449, (Aug. 31, 1969), p. 92.
75. J. W. Cooke, *Development of the Variable-Gap Technique for Measuring the Thermal Conductivity of Fluoride Salt Mixtures*, ORNL-4831 (Feb. 1973).
76. C. F. Baes, Jr., R. P. Wichner, C. E. Bamberger and B. F. Freasier, "Removal of Iodide from LiF-BeF₂ Melts by HF-H₂ Sparging - Application of Iodine Desorption from MSBR Fuel," to be published.
77. L. M. Toth, J. P. Young and G. P. Smith, *Anal. Chem.* 41: 683-5 (1969).
78. L. Kolditz and Cheng-Shan Lung, *Z. Chem.* 12: 469 (1967).
79. R. F. Apple and A. S. Meyer, *MSRP Semiannu. Progr. Rept. Aug. 1970*, ORNL-4548, p. 185.
80. J. P. Young, J. B. Bates and G. E. Boyd, *MSR Program Semiannu. Progr. Rept. for Period Ending Feb. 1972*, ORNL-4782, p. 53.
81. S. Cantor, ORNL-TM-2316, p. 34 (1968); *Reactor Chem. Div. Ann. Progr. Rept. Dec. 31, 1967*, ORNL-4229, pp. 55-57.
82. H. Tanaka, A. Yanaguchi and J. Moriyama, *Nippon Kinzaki Gakkai-Si* 35: 1161 (1971).
83. J. W. Koger, *Corrosion and Mass Transfer Characteristics of NaBF₄-NaF (92-8 mole %) in Hastelloy N*, ORNL-TM-3866 (1972), p. 21.
84. C. J. Barton, L. O. Gilpatrick et al., *Reactor Chem. Div. Annual Prog. Report Dec. 31, 1967*, ORNL-4229, p. 17.
85. J. H. Shaffer and W. P. Teichert, *Reactor Chem. Div. Annual Prog. Report May 31, 1972*, ORNL-4801, p. 44.
86. A. S. Dworkin and M. A. Bredig, *J. Chem. Eng. Data* 15: 505 (1970).
87. J. W. Cooke, *MSR Program Semiannu. Progr. Rept. for Period Ending Aug. 31, 1969*, ORNL-4449, p. 92.
88. P. E. Field and J. H. Shaffer, *J. Phys. Chem.* 71: 3218 (1967).
89. A. P. Malinauskas, D. M. Richardson, J. E. Savolainen and J. H. Shaffer, *Ind. Eng. Chem. Fund.* 11: 584 (1972).
90. J. P. Young, J. B. Bates and G. E. Boyd, *MSR Program Semiannu. Progr. Rept. Feb. 1972*, ORNL-4782, p. 59.

91. R. B. Briggs, J. R. Engel and P. N. Haubenreich, *The Development Status of Molten-Salt Breeder Reactors*, ORNL-4812, p. 413.
92. R. B. Briggs and R. B. Korsmeyer, *Distribution of Tritium in a 1000 MW(e) MSBR*, ORNL-CF-70-3-3 (March 18, 1970).
93. F. Fairbrother, *The Chemistry of Niobium and Tantalum*, Elsevier, New York, 1967.
94. S. Senderoff and G. W. Mellors, *J. Electrochem. Soc.* 113: 66 (1966).
95. G. Ting, C. F. Baes, Jr., and G. Mamantov, *MSR Program Semiannu. Progr. Rept. for Period Ending Feb. 29, 1972*, ORNL-4782, pp. 87-91.
96. J. D. Redman and C. F. Weaver, *MSR Program Semiannu. Progr. Rept. for Period Ending Feb. 29, 1972*, ORNL-4782, pp. 91-95.
97. L. M. Toth and L. O. Gilpatrick, unpublished results.
98. C. F. Weaver et al., *SR Program Semiannu. Progr. Rept. for Period Ending Feb. 28, 1969*, ORNL-4396, p. 157-62.
99. L. M. Toth, J. R. Young, and G. P. Smith, *MSR Program Semiannu. Progr. Rept. for Period Ending Feb. 29, 1968*, ORNL-4254, p. 136.
100. Gann Ting, *Thermodynamic and Electrochemical Studies of Niobium in Molten Fluorides and Chloroaluminates*, Ph.D. Thesis, University of Tennessee, Knoxville (August 1973).
101. N. J. Meyer, C. F. Baes, Jr., and K. A. Romberger, *Reactor Chem. Annual Rept. for Period Ending Dec. 31, 1967*, ORNL-4229, p. 32.
102. J. F. Elliott and M. Gleiser, *Thermochemistry for Steelmaking*, Addison-Wesley, Reading, Mass., 1960.
103. E. K. Storms, *The Refractory Carbides*, Academic Press, New York, 1967, p. 61.
104. R. P. Wichner and C. F. Baes, Jr., *Sidestream Processing for Continuous Iodine and Xenon Removal from MSBR Fuel*, ORNL-CF-72-6-12 (1972).
105. A. Houtzeel and F. F. Dyer, *A Study of Fission Products in the Molten-Salt Reactor Experiment by Gamma Spectrometry*, ORNL-TM-3151 (August 1972).
106. W. K. Furlong, *Conceptual System Design Description of the Molten Salt Loop for Testing Gas Systems*, ORNL-CF-71-1-40 (Jan. 1971).
107. L. E. McNeese, *The Development Status of Molten-Salt Breeder Reactors*, ORNL-4812 (August 1972), p. 352.

6. ANALYTICAL RESEARCH AND DEVELOPMENT

6.1 INTRODUCTION

6.1.1 Objective

Analytical research and development activities will be directed toward providing the chemical devices and methods for the analyses required to achieve a safe and efficient molten-salt breeder reactor. To this end the highest priority will be assigned to demonstration of the feasibility of in-line methods for constituents or properties of reactor streams that are deemed essential for power reactor operation. Essential determinations will include the redox condition of the fuel, total uranium concentration in the fuel, oxide and bismuth contamination, corrosion indicators in the fuel and coolant, and measurements of tritium distribution throughout the system. Because of the importance of such determinations, a diversity of approaches will be investigated. A similar redundancy may ultimately be employed in operating reactors to provide "back-up" measurements for essential determinations.

A second important objective is that of developing the analytical devices and methods required by the Program to conduct meaningful studies and experiments on technology development in diverse areas including development of materials for the reactor primary circuit, fuel processing, and the distribution and containment of tritium. Such developments will, as far as possible, be timed to coincide with the needs of the Program and may in many cases precede the design of perfected transducers for reactor application. Experience in this and other reactor technology programs has generally demonstrated the value of in-line methods both in more economical analyses and in more timely and frequently more meaningful results. The nature of MSBR salt streams (sensitivity of samples to atmospheric contamination, equilibrium shifts on cooling, and importance of oxidation state of constituents) further enhances the value of in situ analysis. Therefore, the analytical research and development program will be directed largely to the development of in-line or in situ methods. Development of methods for the analysis of discrete salt samples will be considered individually as the need arises.

This development activity will generate a diversity of in-line analytical techniques many of which will not be employed in an operating reactor. A continuous evaluation will be made to identify those in-line techniques that would provide the most valuable data and to develop as many as are technically feasible in order that they can be incorporated into development systems as well as test and demonstration reactors. In the final application of analytical devices to power reactors, the number of analytical transducers would be reduced to a more modest level that includes only those essential to safe operation and those which have been demonstrated to contribute to an economically justifiable increase in plant efficiency.

6.1.2 Scope

The scope of this activity includes the following areas of methodology:

In-line Electrochemical Analyses (Task Group 5.1)

Application of Spectrophotometric Methods (Task Group 5.2)

Analyses by Chemical Methods (Task Group 5.3)

Analysis of Gas Streams (Task Group 5.4)

Detection of Fission Products and Pa by Gamma Spectrometry (Task Group 5.5)

In-line Analytical Test Facility (Task Group 5.6)

Special Studies (Task Group 5.7)

Each of these task groups is expected to contribute analysis methods applicable to the three functional subdivisions of the reactor: the fuel system, the reprocessing system and the coolant system. The last task group, Special Studies, incorporates a variety of activities including the investigation of advanced approaches to which only cursory study has yet been given; the simultaneous use of two or more of the first six techniques; the exploitation of technological breakthroughs; the application, with automation where practical, of fully developed in-line or in situ methods in support of other Program activities; and the evaluation of the various methods in terms of final reactor requirements.

6.2 PROGRAM BUDGET AND SCHEDULE

6.2.1 Schedule and key program milestones

The schedule for work on analytical research and development is shown in Table 6.2.1.1. The key program milestones for this activity are listed in Table 6.2.1.2 and occur at the times indicated in Table 6.2.1.1.

6.2.2 Budget

The operating funds required by this activity are shown in Table 6.2.2.1, and capital equipment fund requirements are given in Table 6.2.2.2.

6.3 REQUIREMENTS, EXPERIENCE, AND STATUS OF DEVELOPMENT

6.3.1 Requirements

In order to exploit fully the unique features of the MSR concept and ensure safe and efficient reactor operation, it will be necessary to maintain adequate surveillance of the composition of various reactor streams. Ideally, all such analyses would be performed automatically

with transducers located in the salt streams, since analysis of discrete samples in hot cells is subject to unavoidable delays and is expensive.

At present, it appears that it may not be practical to measure major fuel constituents such as Li, Be, Th, and fluoride, by in-line methods in an MSBR. Fortunately, continuous monitoring of these constituents will not be critical to the operation of a reactor. The more critical determinations, on the other hand, are generally amenable to in-line measurement. Determinations which appear to be of most significance include the redox condition of the fuel,* corrosion product ions (particularly Cr^{2+}), oxide, bismuth, hydrogen and tritium, certain fission products, and protactinium in fluoride streams. The accurate determination of total uranium concentration (with an accuracy of about 1 part in 10^4) in the fuel salt would also be quite useful in the calculation of long-term reactivity balances. Determinations for some materials will be required in the chloride streams of the fuel processing system. Similarly, methods will be required to monitor corrosion products in the coolant salt together with free and combined hydrogen and tritium, oxygenated species and any redox buffer couple which may be incorporated into the coolant salt. In-line analyses for permanent gas contaminants, moisture, tritium, hydrocarbon, and fission product gases will be needed in the fuel cover gas. To this must be added BF_3 , HF, hydrogen, and hydrolysis products in the coolant cover gas (or analogous constituents if an alternate coolant is selected), and perhaps HF, F_2 , and UF_6 in gaseous streams from the processing system.

It should be noted that in addition to economics of time and expense, the in-line techniques will provide information not attainable by discrete sampling methods. A notable example is the $\text{U}^{3+}/\text{U}^{4+}$ ratio in the fuel. This ratio is prohibitively sensitive to atmospheric contamination during sampling and sample transfer in hot cells, and is rather meaningless on frozen samples because the ratio undergoes changes during cooling as a result of shifts in equilibrium. Another example is the determination of trace constituents in gases, which is notoriously difficult if not impossible to effect by withdrawing samples.

It is evident that the ultimate need for an MSBR is an analytical system that includes all needed in-line analytical measurements that are feasible, backed up by adequate hot cell and analytical laboratories. In the interim period it is also necessary to develop capabilities and to provide analytical support for the technology development activities in the Program.

*The $\text{U}^{3+}/\text{U}^{4+}$ ratio is a measure of the redox potential of the fuel which influences the rate of corrosion and the distribution of certain fission products and tritium in the reactor system.

Table 6.2.1.1. Schedule for analytical research and development

	Fiscal year												
	1975	1976	1977	1978	1979	1980	1981	1982	1983	1984	1985	1986	
5.1 In-line electrochemical analyses	∇ ^a	∇ ^b	∇ ^c				∇ ^d			∇ ^e			
5.2 Application of spectrophotometric methods to MSRP salts			∇ ^c			∇ ^f		∇ ^d	∇ ^e		∇ ^g		
5.3 Analyses by chemical methods		∇ ^c	∇ ^h				∇ ^d				∇ ^e		
5.4 Analysis of gas streams			∇ ⁱ	∇ ^c			∇ ^d				∇ ^e		
5.5 Detection of fission products and Pa by gamma spectrometry											∇ ^j		
5.6 In-line Analytical Test Facility				∇ ^k		∇ ^l					∇ ^m		
5.7 Special studies	∇ ⁿ		∇ ^o										∇ ^p

Table 6.2.1.2. Key milestones for analytical research and development

Milestone	Description
a	Complete basic tellurium study
b	Complete basic evaluation of electrochemical bismuth methods
c	Complete development of methods for corrosion products and protonated species for NaBF_4
d	Start evaluation of radiation effects on methods
e	Complete essential methods for processing system
f	Demonstrate feasibility of precise spectrophotometric methods to $\pm 1\%$ level
g	Establish ultimate precision of spectral methods for total uranium
h	Develop practical in-line transpiration system for testing
i	Evaluate gas-chromatographic and mass-spectrometric methods for testing
j	Complete evaluation of γ -spectrometry capabilities
k	Complete construction of Analytical Test Facility
l	Demonstrate in-line oxide method for fuel streams
m	Complete tests of in-line transpiration measurements (includes bismuth, oxide in fuel, etc.)
n	Complete basic studies of radiolytic oxide removal
o	Start in-line applications of analytical methods
p	Submit recommendations for complete chemical analysis for reactors

Table 6.2.2.1. Summary of operating budget for analytical research and development
(costs in 1000 dollars)

	Fiscal year											
	1975	1976	1977	1978	1979	1980	1981	1982	1983	1984	1985	1986
5.1 In-line electrochemical analyses	85	95	100	123	140	150	157	150	138	90	70	
5.2 Application of spectrophotometric methods to MSRP salts	22	43	55	65	88	80	76	70	80	50	40	
5.3 Analyses by chemical methods	24	44	54	60	67	65	75	60	60	80	60	
5.4 Analysis of gas streams	16	35	44	45	48	60	65	70	60	60	40	
5.5 Detection of fission products and Pa by gamma spectrometry						15	30	45	45	50	30	
5.6 In-line Analytical Test Facility	12	30	40	50	60	65	70	70	40			
5.7 Special studies	21	43	57	67	77	80	80	85	90	130	125	
Total	180	290	360	410	480	515	553	550	513	460	365	

Table 6.2.2.2. Summary of capital equipment funds required for analytical chemistry research and development (costs in 1000 dollars)

	Fiscal year										
	1975	1976	1977	1978	1979	1980	1981	1982	1983	1984	1985
5.1 In-line electrochemical analyses	8	5	43	13	5		7				
5.2 Application of spectrophotometric methods	6	27	26	53	4	75	30	20			
5.3 Analysis by chemical methods	2	13	1	30	9						
5.4 Analysis of gas streams		25	27		5	37	5				
5.5 Detection of fission products and Pa by gamma spectrometry							50			30	
5.6 In-line Analytical Test Facility		100									
5.7 Special studies	9	38	56	60	118	80	5				
Total capital equipment funds	25	208	153	156	141	192	97	20		30	

6.3.2 Experience

The major development of analytical methods for discrete samples was associated with the operation of the MSRE. The analytical methods for this reactor were developed to support the objectives of the chemical surveillance program.¹ With the exception of in-line analyses of the off-gas and remote gamma spectrometry (described later in this section), all analyses were performed on batch samples either in hot cells or by bench-top methods.

Prior to the MSRE program, substantial experience was gained in the handling and analysis of nonradioactive fluoride salts in the ANP Program. Ionic or instrumental methods had been developed for most metallic constituents, and methods were available for F^- (pyrohydrolysis)² and sulfur.³ For MSRE application, it was necessary to adapt these methods to hot-cell operations. A technique involving the evolution of elemental oxygen by reaction with BrF_3 has since resulted in the versatile $KBrF_4$ method⁴ (for oxide in inorganic samples. A non-selective measurement of "reducing power" of adequate sensitivity had been developed (hydrogen evolution method).⁵ A general expertise⁶ in the radiochemical separation and measurement of fission products was available from earlier reactor programs at ORNL, and useful experience with in-line gas analysis, particularly process chromatograph,⁷ was available from other programs.

During the operation of the MSRE and in the subsequent technology program, development of methods for discrete samples was continued, and the Laboratory acquired instrumentation for newer analytical techniques. Instrumental methods which have or are expected to contribute to the program include: x-ray absorption, diffraction, and fluorescence techniques; NMR; spark source mass spectrometry; ESCA and Auger spectrometry; electron microprobe measurements; scanning electron microscopy; Raman spectrometry; Fourier transform spectrometry; neutron activation analysis; delayed neutron methods; photon activation analysis; and scanning with high-energy particles, e.g. protons. The detailed description of all analytical methods available to the program is beyond the scope of this discussion. Tabulation of analytical capabilities at ORNL and within the Oak Ridge complex are reported elsewhere.⁸ Certain developments merit additional mention and are discussed below.

6.3.2.1 Sampling

The preparation of homogenized samples of MSRE fuel for elemental analyses presented problems because of the radioactivity and the hydroscopic nature of the salt.⁹ Salt samples were taken in small copper ladles which were sealed under helium in a transport container in the sampler-enricher¹⁰ for delivery to the hot cell. There the ladle was unloaded and sectioned. The salt was removed from the truncated ladle and homogenized by vigorous shaking in a pulverizer vessel. Salt transfer was then made to a polyethylene vial threaded in the bottom of the pulverizing vessel with minimal atmospheric exposure. This procedure provided a free-flowing

powdered sample within two hours of receipt of the ladle. Atmospheric exposure was sufficient to compromise the determination of oxide and U^{3+} , but did not affect other measurements.

6.3.2.2 Oxide

Because of the sensitivity of the pulverized salt to unavoidable atmospheric contamination, transpiration techniques in which the entire sample could be analyzed were adopted. For the more critical determinations, the most successful application of transpiration techniques was the determination of oxide by hydrofluorination.¹¹ The method is based on the evolution of water which occurs when melts are sparged with mixtures of anhydrous HF and hydrogen. By removing surface moisture with a premelting hydrofluorination step and by measuring the water evolved from 50-g samples as an integrated signal from an electrolytic moisture monitor, oxide concentrations of about 50 ppm were measured with precision better than ± 10 ppm.

6.3.2.3 Uranium

Analyses for uranium by coulometric titration¹² showed good reproducibility and high precision (0.5%), but on-line reactivity balance calculations were about 10-fold more sensitive than this in establishing changes in uranium concentrations within the MSRE fuel salt circuit. Reactivity balance in an MSBR may be less useful, however, because of uncertainties introduced by continuous processing of the fuel salt. It was demonstrated that uranium from the fluorination of 50-g samples of molten fuel could be quantitatively collected as decontaminated UF_6 . The technique was used primarily to separate uranium for precise isotopic analysis, but sufficient work was done to establish its potential for more accurate uranium determination by measurement of the separated uranium outside the hot cell.

6.3.2.4 U^{3+}

A hydrogenation-transpiration method was developed for the determination of U^{3+} in fuel salt.¹³ The rate of production of HF from the sparging of fuel with hydrogen is a function of the instantaneous ratio of U^{3+}/U^{4+} . A computer program was developed to compute yields of HF from the reduction of UF_4 and corrosion product fluorides as a function of composition and reduction conditions and thus permit estimation of U^{3+} concentrations from the integrated HF yields from sequential reduction steps at two temperatures. Results of such measurements were in reasonable agreement with "book values" computed from reactor charging and operating data during ^{235}U operation.¹⁴ The method proved inadequate for use with the lower concentrations of uranium in the ^{233}U fuel.

A voltammetric method was tested for the measurement of U^{3+}/U^{4+} ratios in remelted fuel samples¹⁵ (see section on Electrochemical Research for a description of voltammetry). Measurements were performed with electrodes inserted in samples remelted in their ladles. More atmospheric exposure was incurred than in the oxide determination, because it was necessary to cut off the top of the ladles to accommodate the electrodes. Accordingly, ratios below those expected were obtained. However, normally shaped reduction waves for Cr^{2+} and U^{4+} were recorded, and the reduction of the fuel by hydrogen sparging was followed voltammetrically. Changes in ratio with temperature were consistent with thermodynamic predictions of equilibrium shifts between the uranium couple and corrosion product ions. This indicated that the radiation level of the samples had negligible effects on the method and supports the potential of voltammetry for application to reactor salt streams.

6.3.2.5 Spectrophotometry of radioactive samples

A facility was constructed¹⁶ which permitted measurements with highly radioactive samples within a hot cell by using the components of a spectrophotometer located outside the cell. A system of extended optics directed the chopped reference and sample beams through the cell walls, focused the sample beam at the center of an optical furnace and returned the two beams through the wall to the monochromator-detector section of the instrument. The system design included devices for remelting large salt samples under inert atmosphere and dispensing portions to spectrophotometric cells, but because of the pending shutdown of the MSRE, a sample system was devised to fill windowless cells by direct immersion in the fuel. Despite precautions to prevent atmospheric exposure, the U^{3+} in the samples was completely oxidized before measurements could be made. The spectrum of U^{4+} was recorded, however, as was that of U^{3+} (following a reduction with uranium metal). Comparison of the spectra of these samples with those of nonradioactive preparations indicated no adverse effects from the activity of the fuel and demonstrated the feasibility of the technique. The facility has since been used to measure the spectra of transuranium elements and protactinium in molten salts.

6.3.2.6 Gas analysis

Equipment was installed at the MSRE to perform limited in-line analyses of the reactor off-gases, using a thermal conductivity cell as a transducer. By means of an oxidation and absorption train¹⁷ both total impurities and hydrocarbons were measured in the off-gas. The sampling station also included a system for the cryogenic collection of xenon and krypton on molecular sieves to provide concentrated samples for the precise determination of the isotopic ratios of krypton and xenon by mass spectrometry. During the last two runs of the MSRE, equipment¹⁸ was installed at the reactor to convert the tritium in various gas streams to water for measurement by scintillation counting.

6.3.2.7 Gamma spectrometry at the MSRE

By means of a precise collimation system mounted on a maintenance shield, radiation from fission products deposited on reactor components was detected by a high-resolution lithium-drifted germanium diode.¹⁹ From the gamma spectra obtained, specific isotopes such as noble metal fission products were identified and their distribution was mapped by moving the collimating system.²⁰ During the latter runs of the reactor such measurements were made during power operation.²⁰

6.3.2.8 Bismuth

Processing of the fuel salt by selective extraction into liquid bismuth (described in Section 3) required the development of more sensitive methods for the determination of bismuth in fuel salt. An inverse polarographic technique was developed which has detection limits of about 50 ppb.²¹ The bismuth is deposited on a pendent mercury drop electrode from HCl solutions in which copper is masked with thiocyanate, and measured during an anodic scan. A spectrographic method of at least equivalent sensitivity was also developed; however, it incorporates a preconcentration by extraction with dithizone and requires large salt samples.

6.3.3 Status of development

Research and/or development studies in the area of analytical chemistry have been carried out in all of the areas outlined in the scope of this activity. Presently, investigations are being continued along lines that emphasize support of technology development within the Program. Because electrochemical methods have proven most successful at this stage of development for in-line measurement, current work is concentrated largely in this area. The status of earlier work on this activity is summarized below.

6.3.3.1 Electrochemical research

For the analysis of molten-salt streams, electroanalytical techniques such as voltammetry and potentiometry appear to offer the most convenient transducers for remote in-line measurements. Voltammetry is based on the principle that when an inert electrode is inserted into a molten salt and subjected to a changing voltage relative to the salt potential, negligible current will flow until a critical potential is reached at which one or more of the ions undergoes an electrochemical reduction or oxidation. The potential at which this reaction takes place is characteristic of the particular ion or ions. If the potential is varied linearly with time, the resulting current-voltage curve follows a predictable pattern in which the current reaches a diffusion-limited maximum value that is directly proportional to the concentration of the electroactive ion or ions.

Basic voltammetric studies have been made on corrosion product ions in the MSRE fuel solvent, $\text{LiF-BeF}_2\text{-ZrF}_4$,²²⁻²⁵ and in the proposed coolant salt, $\text{NaBF}_4\text{-NaF}$.²⁴⁻²⁶ Most of this work is concerned with the determination of oxidation states of the elements, the most suitable electrode materials for their analysis, and the basic electrochemical characteristics of each element. It has been shown that relatively high concentrations (typically, 20 ppm) can be estimated directly from the height of the voltammetric waves. Lower concentrations can be measured using the technique of stripping voltammetry through observation of the current produced when a corrosion product is oxidized from an electrode on which it has previously been plated.²⁷ Only limited studies of the stripping technique have been made in molten fluoride salts.

A voltammetric method has been developed for the determination of $\text{U}^{3+}/\text{U}^{4+}$ ratio in the MSRE fuel.¹⁵ This method involves the measurement of the potential difference between the equilibrium potential of the melt, measured by a noble electrode, and the voltammetric equivalent of the standard potential of the $\text{U}^{3+}/\text{U}^{4+}$ couple. The reliability of the method was verified by comparison with values that were obtained spectrophotometrically.²⁸ This determination has been completely automated with a PDP-8 computer²⁹ which operates the voltammeter, analyzes the data, and computes the $\text{U}^{3+}/\text{U}^{4+}$ ratio. Recently, the method was used to determine $\text{U}^{3+}/\text{U}^{4+}$ ratios in a thorium bearing fuel solvent, $\text{LiF-BeF}_2\text{-ThF}_4$ (60-20-12 mole %). Ratios covering the range of 10^{-5} to $>10^{-2}$ were measured during the reduction of the fuel in a forced-convection loop (FCL-2b). The data, not yet completely analyzed, support the reliability of the method in this medium.

Because the fuel processing operation³⁰ presents the possibility for introducing bismuth into the fuel, a method for bismuth determination is required. The reductive behavior of Bi^{3+} was characterized in $\text{LiF-BeF}_2\text{-ZrF}_4$,²⁵ and it was found that it is rather easily reduced to the metal. As an impurity in the fuel salt, bismuth will probably be present in the metallic state, so that some oxidative pretreatment of the melt will be necessary before a voltammetric determination of bismuth can be performed.

The measurement of the concentration of protonated species in the proposed MSBR coolant salt is of interest because of the potential use of the coolant for the containment of tritium. The measurement could also be used to evaluate the effect of proton concentrations on corrosion rates and as a possible detection technique for steam generator leaks. A rather unique electroanalytical technique that is specific for hydrogen was investigated.^{25,31} The method is based on the diffusion of hydrogen into an evacuated palladium-tube electrode when NaBF_4 melts are electrolyzed at a controlled potential. The pressure generated in the electrode is a sensitive measure of protons at ppb concentrations. The technique offers the advantages of specificity, applicability to in-line analysis, and the possibility of a measurement of tritium-to-hydrogen ratios in the coolant by counting the sample collected from the evacuated tube. Measurements by this technique, together with observations in other areas

of analytical research, has led to the discovery that at least two forms of combined hydrogen are present in NaBF_4 melts. In addition to infrared-active BF_3OH , which is not easily reduced, a more labile electroactive species is present in equilibrium with a condensible species in the gas phase. In all electroanalytical measurements it is a distinct advantage to have an invariant reference potential to which other electrochemical reactions may be referred on a relative potential scale. A practical reference electrode must be fairly rugged and of unit construction. The major problem was to find non-conducting materials which would be compatible with fluoride melts. Successful measurements were performed with a Ni/NiF_2 electrode, in which the reference solution (LiF-BeF_2 saturated with NiF_2) is contained within a single-crystal LaF_3 cup.^{32,33} Standard electrode potentials were determined for several metal/metal-ion couples which will be present in the reactor salt streams.²⁸ These electrode potentials provide a direct measure of the relative thermodynamic stability of electroactive species in the melts. This information can be used in equilibrium calculations to determine which ions would be expected to be present at different melt potentials.

6.3.3.2 Spectrophotometric research

Because molten fluorides react with the usually employed light transmitting glasses, special cell designs have been developed for the spectrophotometric examination of MSBR melts. The pendent-drop technique³⁴ that was first developed was later replaced with the captive-liquid cell³⁵ in which molten salts are contained by virtue of their surface tension, so that no window material is required. A concept has been proposed for the use of this cell in an in-line system.³⁶ Although the light path length through a salt in a captive-liquid cell is determinable, it is not fixed. The need for a fixed path length promoted the design and fabrication of a graphite cell having small diamond-plate windows³⁷ which has been used successfully in a number of research applications. Another fixed-path-length cell which is still in the development stage makes use of a porous metal foil³⁸ that contains a number of small irregular pits formed electrochemically; many of the pits are etched completely through the foil, so that light can be transmitted through the metal. Porous metal made from Hastelloy N has been purchased to test its use for cell construction.

The latest innovation in cell design is an optical probe which lends itself to a sealable insertion into a molten salt stream.³⁹ The probe makes use of multiple internal reflections within a slot of appropriate width cut through some portion of the internally reflected light beam.³⁹ During measurements the slot would be below the surface of the molten salt and would provide a known path length for absorbance measurements. It is believed that the probe could be made of LaF_3 for measurements in NaBF_4 streams.

Spectrophotometric studies of uranium in the +3 oxidation state have shown that this method is a likely candidate for in-line determination of U^{3+} in the reactor fuel.^{40,41} An extremely sensitive adsorption peak

for U^{4+} (42) may be useful for monitoring residual uranium in depleted processing streams. Quantitative characterizations, including absorption peak positions, peak intensities, and the assignment of spectra, have been made for Ni^{2+} , Fe^{2+} , Cr^{2+} , Cr^{3+} , U^{5+} , UO_2^{2+} , Cu^{2+} , Mn^{2+} , Mn^{3+} , Co^{2+} , Mo^{3+} , CrO_4^{2-} , Pa^{4+} , Pu^{3+} , Pr^{3+} , Nd^{3+} , Sm^{3+} , Er^{3+} , and Ho^{3+} . Semiquantitative characterizations, including absorption peak positions, approximate peak intensities, and possible assignment of spectra, have also been made for Ti^{3+} , V^{2+} , V^{3+} , Eu^{2+} , Sm^{2+} , Cm^{3+} , and O_2^- .

Investigation of protonated species in the proposed coolant were made. Evidence for the existence of hydrogen-containing impurities in $NaBF_4$ was first obtained from near-infrared spectra of the molten salt and in mid-infrared spectra of pressed pellets of the crystalline material.⁴³ In deuterium exchange experiments attempted in fluoroborate melts, two sensitive absorption peaks corresponding to BF_3OH^- and BF_3OD^- were identified. There was no evidence that deuterium would exchange with BF_3OH^- , rather, BF_3OD^- was generated via a redox reaction with impurities in the melt.⁴⁴ The absorption spectra of several other species have been observed in fluoroborate melts.⁴⁵ Work on spectrophotometric methods is also providing data for the identification and determination of solute species in the various melts of interest for the fuel salt processing system.²⁵

6.3.3.3 Transpiration and gas analysis

Although the transpiration approach offers the advantage of locating transducers for effluent gas analysis outside the highest radiation zones, these devices will still receive exposure from fission-product gases and their daughters and possibly from particulate radioactive materials, and thus they will require remote operation. The only research performed on such transducers has been on methods for batch samples of the MSRE fuel. The electrolytic moisture monitor was demonstrated to provide more than adequate sensitivity for the measurement of water from the hydrofluorination method for oxide and to have adequate tolerance for operation at the anticipated radiation levels.⁴⁶ A method has been developed for the remote measurement of micromolar quantities of HF generated by hydrogenation of fuel samples using a thermal-conductivity method after preconcentration by trapping on NaF.⁴⁷

Commercial gas chromatographic components for high-sensitivity measurement of permanent gas contaminants are not expected to be acceptable at the radiation levels of the MSBR off-gas. Valves contain elastomers which are subject to radiation damage and whose radiolysis products would contaminate the carrier gas. The more sensitive detectors generally depend on ionization by weak radiation sources and would obviously be affected by sample activity. A prototype of an all-metal sampling valve⁴⁸ has been constructed to effect 6-way, double-throw switching of gas streams with closure effected by a pressure-actuated metal diaphragm. A helium breakdown detector was found to be capable of measuring sub-ppm concentrations of permanent gas impurities in helium. Use of this detector in a simple chromatograph on the purge gas of an in-pile capsule

test (MTR-47-6) demonstrated that it was not affected by radioactivity.⁴⁹ Ironically, subsequent tests with a more highly purified carrier gas revealed sporadically noisy operation caused by unstable discharges.⁴⁸ Tests to circumvent this difficulty by controlled impurity additions were suspended because of higher priority problems.

The analysis of the coolant cover gas involves less radioactivity but more complex chemical problems. Methods are being investigated for the determination of condensable material tentatively identified as BF_3 hydrates and hydrolysis products⁵⁰ and for other forms of hydrogen and tritium. "Dew-point" and diffusion methods offer promise for such measurements.⁵¹ An improved Karl Fischer coulometric titrator was developed to provide calibration measurements of "water" in both simulated and actual cover gas samples.

6.3.3.4 In-line applications

The first successful chemical analysis of a flowing molten fluoride salt stream⁵² was demonstrated by measuring $\text{U}^{3+}/\text{U}^{4+}$ ratios in a loop being operated to determine the effect of salt on Hastelloy N under both oxidizing and reducing conditions. The test facility was a Hastelloy N thermal-convection loop (NCL-21) in which $\text{LiF}-\text{BeF}_2-\text{ZrF}_4-\text{UF}_4$ circulated at about five linear feet per minute. The analytical transducers were platinum and iridium electrodes that were installed in a surge tank where the temperature was controlled at 650°C.

The $\text{U}^{3+}/\text{U}^{4+}$ ratio was monitored over a period of several months on a completely automated basis. A new cyclic voltammeter, which provides several new capabilities for electrochemical studies on molten-salt systems, was designed for use with this system. The voltammeter can be directly operated by a PDP-8 type computer.⁵³ A PDP-8I computer was used to control the analysis system, analyze the experimental output, make the necessary calculations, and print out the results. As equilibrium conditions were being established, increases in the U^{3+} concentration were followed as chromium was slowly dissolved from the Hastelloy N, causing U^{4+} to be reduced. Precipitous drops in the U^{3+} concentrations were observed due to the introduction of oxidizing contaminants when metal specimens were inserted into the melt.⁵⁴

In-line measurements of $\text{U}^{3+}/\text{U}^{4+}$ ratios and Cr^{2+} concentrations are now being made in fuel salt in a forced-convection loop (FCL-2b). Severe vibration problems distort the waves and reduce the accuracy of the measurements when the fuel is pumped at high velocity, but excellent voltammograms are obtained when the pump is stopped. A special shielded electrode assembly is being fabricated to reduce the effect of vibrations in this and similar locations.

Provisions have been made in the design of the two engineering loops, the Coolant-Salt Technology Facility (CSTF) and the Gas-System Technology Facility (GSTF), for the installation of analytical transducers. In

brief studies in the CSTF, reduction waves for Fe^{3+} , Fe^{2+} , Cr^{2+} and possibly Mo^{3+} were observed at concentrations from 20 to 100 ppm. First order decay of active protons was observed to concentrations as low as a few ppb.

6.4 TASK GROUP 5.1 IN-LINE ELECTROCHEMICAL METHODS

6.4.1 Objective

The objective of Task Group 5.1 is to develop electroanalytical methods for the analysis of fuel, coolant and processing salt streams of test, demonstration, and power reactors on a schedule that will permit the use of such methods in support of technology development activities for the MSBR program. Experience has shown that certain electroanalytical methods, voltammetry and perhaps potentiometry, offer the most convenient transducers for in-line installation. Therefore, such methods are expected to receive the most usage - at least early in the development program. The development of practical in-line methods must be preceded by the generation of basic data, such as standard electrode potentials, diffusion coefficients, conditions of reversibility, etc. by using other electrochemical techniques as chronopotentiometry, and coulometry. These basic studies will also provide valuable data on the behavior of ions in melts.

6.4.2 Schedule

The schedule for work in this task group is shown in Table 6.4.2.

6.4.3 Funding

Operating fund requirements for this task group are shown in Table 6.4.3.1, and capital equipment fund requirements are shown in Table 6.4.3.2.

6.4.4 Facilities

Most of the basic studies and initial development efforts will be performed in existing facilities of rather modest requirements (analytical laboratories with standard hoods). As the program proceeds and materials involving progressively more severe radiation hazards are encountered, space will be used in existing alpha-containment facilities either at the Transuranium Laboratory or the MSRP alpha facility in Building 4501. Ultimately, an existing hot cell facility such as the Hot-Cell Spectrophotometric Installation may be required to contain melts emitting more penetrating radiation. Also, the engineering installations in which in-line measurements are made serve as facilities for this task group, because the in-line measurements made therein may reveal practical deficiencies in the methods. In addition, installations containing large quantities of salt sometimes present opportunities for stability

Table 6.4.2. Schedule for work in Task Group 5.1 - In-line electrochemical methods

	Fiscal year											
	1975	1976	1977	1978	1979	1980	1981	1982	1983	1984	1985	1986
5.1.1 Fuel salt analysis												
5.1.1.1 U ³⁺ /U ⁴⁺												
5.1.1.2 Ionic corrosion products												
5.1.1.3 Bismuth												
5.1.1.4 Tellurium												
5.1.1.5 Protactinium												
5.1.1.6 Plutonium												
5.1.1.7 Total corrosion products												
5.1.1.8 Total uranium												
5.1.1.9 Protonated species												
5.1.1.10 Oxide												
5.1.1.11 Niobium												
5.1.1.12 Chloride												
5.1.1.13 Noble-metal fission products												
5.1.1.14 Salt soluble fission products												
5.1.1.15 Reference electrodes												
5.1.2 LiCl analyses												
5.1.2.1 Uranium												
5.1.2.2 Ionic corrosion products												
5.1.2.3 Thorium												
5.1.2.4 Plutonium												
5.1.2.5 Fluoride												
5.1.2.6 Reference electrodes												
5.1.2.7 Total corrosion products												
5.1.2.8 Oxide												

Table 6.4.2 (continued)

	Fiscal year												
	1975	1976	1977	1978	1979	1980	1981	1982	1983	1984	1985	1986	
5.1.3 Coolant salt analysis													
5.1.3.1 Ionic corrosion products													
5.1.3.2 Protonated species													
5.1.3.3 Hydrogen isotopes													
5.1.3.4 Redox buffer couples													
5.1.3.5 Reference electrodes													
5.1.3.6 Total corrosion products													
5.1.3.7 Oxygenated species													
5.1.4 Effects of radiation on electro-analytical transducers													

Table 6.4.3.1. Operating fund requirements for Task Group 5.1 -- In-line electrochemical methods
(costs in 1000 dollars)

	Fiscal year											
	1975	1976	1977	1978	1979	1980	1981	1982	1983	1984	1985	1986
5.1.1 Fuel salt analysis												
5.1.1.1 U ³⁺ /U ⁴⁺	12	10	10									
5.1.1.2 Ionic corrosion products	10	10	10	12								
5.1.1.3 Bismuth	11	10										
5.1.1.4 Tellurium	12											
5.1.1.5 Protactinium		15	10									
5.1.1.6 Plutonium			15	10	10							
5.1.1.7 Total corrosion products			5	10	12							
5.1.1.8 Total uranium				6	12	15						
5.1.1.9 Protonated species				6	10	12						
5.1.1.10 Oxide				7	9	12	20					
5.1.1.11 Niobium					10	15	20					
5.1.1.12 Chloride					10	15	10					
5.1.1.13 Noble-metal fission products							10	15	15	15	15	
5.1.1.14 Salt-soluble fission products							10	15	15	15	15	
5.1.1.15 Reference electrodes	1	5	5	9								
Subtotal 5.1.1	46	50	55	60	73	69	70	30	30	30	30	
5.1.2 LiCl analyses												
5.1.2.1 Uranium				8	9							
5.1.2.2 Ionic corrosion products				8	9	12						
5.1.2.3 Thorium					8	12						
5.1.2.4 Plutonium						7	10	12				
5.1.2.5 Fluoride						8	12	16				
5.1.2.6 Reference electrodes					8	10	12	15				

Table 6.4.3.1 (continued)

	Fiscal year											
	1975	1976	1977	1978	1979	1980	1981	1982	1983	1984	1985	1986
5.1.2.7 Total corrosion products							4	12	16			
5.1.2.8 Oxide					7	8	12	15	12			
Subtotal 5.1.2				16	41	57	50	70	28			
5.1.3 Coolant salt analysis												
5.1.3.1 Ionic corrosion products	10	10	10	8								
5.1.3.2 Protonated species	15	10	8									
5.1.3.3 Hydrogen isotopes	7	10	7	7	6	6						
5.1.3.4 Redox buffer couples			7	8	10							
5.1.3.5 Reference electrodes		5	8	8	10	10	12					
5.1.3.6 Total corrosion products		5	10	8								
5.1.3.7 Oxygenated species	7	5	5	8								
Subtotal 5.1.3	39	45	55	47	26	16	12					
5.1.4 Effects of radiation on electro-analytical transducers						8	25	50	80	60	40	
Total operating funds for Task Group 5.1	85	95	110	123	140	150	157	150	138	90	70	

Table 6.4.3.2. Capital equipment fund requirements for Task Group 5.1 —
 In-line electrochemical analyses
 (costs in 1000 dollars)

	Fiscal year							
	1975	1976	1977	1978	1979	1980	1981	1982
5.1 Miscellaneous items	8	5	18	13	5		7	
5.1 Inert atmosphere box			25					
Total capital equipment funds for Task Group 5.1	8	5	43	13	5		7	

studies and calibrations that are not feasible with small research melts. Final perfection of many of the in-line electrochemical methods will be performed with salt streams delivered by the Analytical Test Facility (ATF) which is discussed in Subsection 6.9.

6.4.5 Task 5.1.1 Fuel salt analysis

The predominant emphasis of past research and development studies has been on measurements in fuel or in melts of fuel solvent composition. These studies have led to successful in-line analyses⁵² and to in situ measurements during the loading of fuel pins under conditions requiring radiation containment.⁵⁵ It is expected that a strong emphasis on fuel analysis will continue throughout the early stages of the program until materials problems are resolved. All of the earlier work was performed in melts of MSRE solvent composition and many of the basic measurements, particularly diffusion coefficients, will have to be repeated in the thorium-bearing breeder compositions. In-line applications may serve as screening tests to eliminate some of the lengthy remeasurements. Measurements will be greatly improved when an insulating material is found that is fully compatible with the fuel. Such a material would permit a more precise definition of electrode areas and thus improve the precision of the measurements. A search for better insulators will be pursued throughout the specific investigations outlined in the subtasks below. Fluoride salt streams associated with the processing system will also be included in this task group, since their properties will be similar to those of the fuel.

6.4.5.1 Subtask 5.1.1.1 Determination of U^{3+}/U^{4+} ratios

The fuel salt redox potential, as indicated by the U^{3+}/U^{4+} ratio, exerts a profound influence on the chemical and, perhaps, some physical properties of the fuel. It determines the corrosiveness of the fuel with respect to structural materials, influences the disposition of certain fission products and tritium, and may affect the surface tension and wettability of melts. The voltammetric determination of U^{3+}/U^{4+} ratio is the most fully developed of the present in-line electroanalytical methods and has been profitably applied to in-line and in situ measurements. Although the method has not yet been studied thoroughly in MSBR fuel salt, it should be generally applicable to any melt in which reversible reduction waves can be recorded. In fact, waves recorded recently during in-line measurements in a thorium-bearing fuel salt in a forced-convection loop exhibit no qualitative differences from those obtained earlier in MSRE fuel salt. The precision of the method is excellent; reproducibility of 2 percent was obtained in MSRE melts during automated operation with digital smoothing and averaging of the voltammeter output. The accuracy of the method is not as well established. It has been found that the potential developed by different noble-metal electrodes may vary by as much as 15 mv when inserted into the same melt. This would correspond to an error in U^{3+}/U^{4+} ratio measurements of about

20 percent. Other potential sources of error include IR drops resulting from the resistance of the melt or of electrode leads, junction potentials, and distortion of the reduction waves caused by melt flow patterns or deposits on the electrodes. These variables are expected to introduce only small and perhaps compensating errors, so that the accuracy of the method is without doubt adequate for present usage in measuring and controlling the redox potential of fluoride salts in technological experiments. For future applications, such as measuring the charge balance of an operating reactor to determine the oxidative effect of fuel burn-up, the highest possible accuracy will be needed.

The effects of all conceivably significant variables will be studied to establish their impact on the accuracy of the method. Where possible, errors will be eliminated or quantified for correction, and specifications will be established for the installation and operating requirements necessary for a particular level of accuracy and precision. When practical, many of these studies will be performed during in-line measurements to provide more realistic evaluation conditions and to effect economies in overall Program effort. It is likely that final perfection of the method will require the use of closely controlled salt streams in the Analytical Test Facility (Task Group 5.6).

6.4.5.2 Subtask 5.1.1.2 Determination of ionic corrosion products

Methods will be required for the continuous determination of ppm concentrations of corrosion product ions, particularly chromous ions, in fuel streams in order to monitor corrosion of reactor fuel systems and to assist in basic studies of corrosion mechanisms. Complete electrochemical characterizations^{17,23-25} have been carried out in MSRE solvents for ions that might enter a moderately oxidizing fuel salt via corrosion of titanium-modified Hastelloy-N, specifically: Fe^{2+} , Ni^{2+} , Cr^{2+} , and Ti^{3+} and Ti^{4+} . Concentrations of the first three of these ions have been estimated during in-line measurements; the measurement of Cr^{2+} in actual fuel melts is subject to interference from the adjacent uranium wave. The electroanalytical chemistry of these ions will be characterized in MSBR fuel salt along with molybdenum and those ions that may be generated by other additions to Hastelloy N. Again, where practical, initial screening studies will be performed during in-line measurements. Efforts will be made to improve the resolution of closely associated waves and the accuracy of the measurements (now estimated at 10 to 20 percent for typical concentrations) by proper selection of electrode materials, better definition of electrode areas, the use of pulsed and stripping techniques, and digital processing of the resulting data (see Task Group 5.7). Such improvements would permit more rapid detection of changes in corrosion rates and, perhaps, the location of areas of more rapid attack in multi-loop systems.

6.4.5.3 Subtask 5.1.1.3 Determination of bismuth

Because bismuth could damage nickel-based structural materials, its concentration must be maintained at tolerable levels in the salt returned from the processing system. Continuous methods that are sensitive to ppb levels of bismuth must be developed to monitor the effectiveness of bismuth removal systems. Electrochemical studies in MSRE solvents have shown that BiF_3 is reduced to the metal at a potential more positive than that for the reduction of nickel with evidence of alloy formation with some electrode materials. In voltammetry, reduction wave heights are proportional to the molar concentrations of the reducible species. The high equivalent weight of bismuth, therefore, makes it highly improbable that the needed sensitivities can be achieved by direct voltammetric measurement. Although stripping techniques can, in theory, be extended to almost any desired concentration level it appears likely that interference from the adjacent nickel wave will limit this approach at the Ni/Bi ratios expected in the fuel. The earlier studies also showed that BiF_3 disappeared slowly from fuel solvent melts, which was attributed to reaction with or absorption by the container material. However, in view of recently reported data,⁵⁶ the observed behavior may have resulted from volatilization. In most reactor streams bismuth will be present as entrained metal particulates. Since electrochemical techniques do not respond to particulates, a necessary part of the analytical development work will be the in-line oxidation of all forms of bismuth to the trivalent state.

High priority will be assigned to establishing the feasibility of in situ bismuth determinations. Measurements will be resumed with the immediately available MSRE solvents in a more impervious container (glassy carbon) than used previously, and work will shift shortly to measurements with MSBR fuel salt when this material is available from salt production activities. The route of BiF_3 depletion will be established. If the material is volatilized from the melt, a transpirational analysis approach will be evaluated (Subtask 5.3.2.4). Studies will be made in melts containing both BiF_3 and NiF_2 . If the anticipated interference is observed, the following approaches for circumventing this difficulty will be tested: (1) Search for an electrode material that will selectively alloy bismuth and thus provide the needed resolution from nickel, (2) removal of co-deposited nickel as $\text{Ni}(\text{CO})_4$ prior to measurement of bismuth by stripping, and (3) further voltammetric reduction of deposited bismuth to the bismuthide.⁵⁷ When electrochemical characteristics are adequately established for in situ measurements, homogeneous reduction of BiF_3 and reoxidation of the dispersed metal will be studied. Efforts within the task will include electrolytic oxidation at porous electrodes and oxidation studies by transpiration methods (Task 5.3.2). Unless unexpectedly stable dispersions of bismuth in salt can be generated, completion of oxidation studies must await availability of the Analytical Test Facility (Task Group 5.6).

6.4.5.4 Subtask 5.1.1.4 Tellurium studies

Because evidence exists that tellurium contributed to intergranular corrosion of standard Hastelloy N in the MSRE, knowledge of its chemistry in fluoride salts is needed for the materials development program. Although it is not expected that in-line electrochemical methods will be practical for measurement of tellurium at concentrations anticipated in an MSR, priority has been assigned to electroanalytical characterization of tellurium species in fuel solvents in order to establish meaningful conditions for evaluation of the resistance of modified Hastelloy N to attack by tellurium. The data obtained (decomposition potentials of the metal, diffusion coefficients and stability ranges of diverse oxidation states) will be of value in designing and executing experiments on development of modified Hastelloy N. Characterization studies have been started in MSRE solvent, and work will shift shortly to MSBR fuel salt. The data obtained in these studies will also be used to assess the potential for electroanalytical measurement of tellurium in materials development experiments. Needed in-line support will be provided for research and development studies in which tellurium concentrations are sufficiently high for measurement.

6.4.5.5 Subtask 5.1.1.5 Determination of protactinium

In order to maintain an overall system doubling time of 19 yrs in an MSBR, protactinium must be continuously removed on a cycle of about 10 days from areas of high neutron flux density. Sensitive in-line methods for its determination will be required to monitor the effectiveness of the protactinium removal system. At steady state operation, the concentration of protactinium in the fuel will be maintained by the processing system at about one percent of that of uranium. Concentrations of this order can be measured by present voltammetric techniques, and expected improvements will provide sufficient sensitivity to detect residual concentrations in processing streams, if interfering waves are not encountered. No electroanalytical measurements have been made for protactinium because of the lack of a facility in which alpha-emitting materials can be used, but estimations of wave positions have been made from thermodynamic considerations. The Pa^{4+} to Pa^{3+} reduction wave should occur at a more negative potential than the U^{3+} to U^0 wave and hopefully will be resolved from the Th^{4+} to Th^{3+} wave which determines the melt limits. The Pa^{4+} to Pa^{5+} oxidation wave should be more cathodic than (precede) the nickel decomposition wave, Ni^0 to Ni^{2+} , which is unlikely to be observed in fuel melts; but may be subject to interference from an iron stripping wave. The protactinium oxidation wave may also be complicated by deposition of oxides since Pa_2O_5 is one of the least soluble oxides in fluoride melts.

On the basis of these considerations, measurements of protactinium in fuel melts may be difficult; however, measurements may be possible at judiciously selected points in the processing system. The effluent from the fluorinator will contain the same concentration of protactinium as the fuel, but with only about equivalent quantities of interfering uranium.

Also, oxide, if present, would be substantially removed by fluorination. Similarly, the concentration of protactinium in the effluent salt from the protactinium extraction step will be essentially equal to that in the stream returned to the reactor, but be largely free of uranium, oxide, iron, and nickel. Thus, the most sensitive measurements can be performed in this stream, which will contain the lowest concentration of protactinium.

Electrochemical characterization of protactinium will be carried out in MSBR fuel carrier salt when facilities and materials are available. It is likely that work will be carried out initially during in situ analyses in support of basic chemical research to determine the free energy of the $\text{Pa}^{4+}/\text{Pa}^{5+}$ couple. Such investigations would be performed in α -facilities in Building 4501, and would provide experience in electroanalytical research on α -containing melts and allow development of criteria for the design of an appropriate α -facility for further electroanalytical research and development. When analytical α -facilities are available, more refined studies of protactinium will be made by using the most advanced electroanalytical techniques in highly purified solvent and in admixture with realistic concentrations of expected interferences. These latter studies may lead to an alternate approach for the electroanalytical measurement of traces of oxide in MSBR fuel salt.

6.4.5.6 Subtask 5.1.1.6 Determination of plutonium

Plutonium will be present in reactor fuels as a major constituent, if PuF_3 is used as a start-up fuel, or in trace concentrations in an MSBR operating on the ^{232}Th - ^{233}U fuel cycle. At this time, no electroanalytical studies of plutonium ions in fluoride melts have been made and there are at present no imminent experiments within the MSR Program that require the electroanalytical determination of plutonium. When alpha-containment facilities are established, the electrochemistry of plutonium will be thoroughly studied in breeder-composition melts. Particular attention will be given to investigation of a reversible soluble redox plutonium couple that could serve as an alternate to the $\text{U}^{4+}/\text{U}^{3+}$ voltammetric method for the measurement of the redox condition of the fuel. Plutonium is expected to be present predominately in the trivalent state and, if another soluble oxidation state can be generated reversibly within the solvent electrolysis limits, the voltammetric technique for ratio measurements can be applied. The possible interference of major and trace concentrations of plutonium with other electroanalytical analyses will be evaluated. Studies with plutonium will be suspended after sufficient basic data has been acquired to establish the feasibility of an in-line plutonium analysis method.

6.4.5.7 Subtask 5.1.1.7 Determination of total corrosion products

Inferences from analytical data from the operation of the MSRE and from thermodynamic considerations indicate that the major fraction of the more-noble corrosion products such as iron and nickel will be present as

particulate metals in an MSBR. A significant fraction of chromium could be incorporated in the particulates by alloying. The measurement of these metallic corrosion products will be needed to provide a completely effective system for monitoring corrosion within the fuel system. Electrolytic techniques will be investigated as a means of converting the particulate matter to measurable ions, perhaps with coulometric integration of the reduction current. Electrochemical methods will also be used to support oxidation studies by chemical means (see Task 5.3.2). Some of the early studies will be made in the GSTF which will be equipped with large penetrations for analytical devices. This early work will provide realistic samples in which the total corrosion product concentrations will be established by repeated chemical analyses.

6.4.5.8 Subtask 5.1.1.8 Determination of total uranium

The electroanalytical measurement of the total concentration of uranium with the precision required to maintain adequate inventory measurements within the primary system appears to be beyond the foreseeable capabilities of these techniques. Precisions substantially better than $\pm 0.1\%$ would be needed to detect losses through deposition that could compromise the nuclear stability of a reactor, and other methods will be developed for determination of long-term reactivity balances (see Section 12). Presently, it is estimated that in appropriate in-line system precisions of $\pm 10\%$ are achievable. Measurements with this precision could provide useful data in some fluoride streams associated with the processing system. Moreover, the precision may be improved to perhaps $\pm 1\%$ by use of precisely defined electrode areas and by application of digital techniques. Potential needs for in-line determination of uranium include the measurement of high concentrations in return streams from the processing system, residual concentrations in processing streams from which the uranium is removed by fluorination or reductive extraction, and trace concentrations in waste salt streams.

Improved techniques for defining electrode areas and reducing salt flow effects will be used to increase the accuracy and precision of the measurement of moderate to high concentrations of uranium in fluoride salts. Developments in pulsed and stripping techniques will be used to increase the sensitivity of the measurements of trace concentrations. Techniques such as chronocoulometry and controlled potential coulometry will be tested for application to salt streams such as the effluent from the protactinium extraction step in which the uranium will be in the trivalent state.

6.4.5.9 Subtask 5.1.1.9 Determination of protonated species

One means of controlling tritium emissions from a molten salt reactor is to operate with the fuel salt at redox conditions that will retain a major fraction of the tritium in a combined form and prevent diffusion of tritium into the coolant salt. Since the concentration of oxide in

the salt will necessarily be low, it is expected that the predominant tritium-containing species will be TF, rather than OT⁻. Measurement of the ratio of free to combined tritium would contribute to studies of tritium distribution in fuel salt systems, and will perhaps be needed to monitor protonated species in the reactor fuel. In the electro-analytical studies involving coolant salts, Task 5.1.3, it has been demonstrated that ppb concentrations of an active proton species, probably HF₂⁻ in NaBF₄, can be measured by controlled-potential electrolysis using an evacuated palladium electrode. Because the electrolyzed hydrogen can be readily recovered in a countable form, the approach is adaptable to the measurement of active tritons in the coolant. It has been proposed, but not yet demonstrated, that the ratio of elemental to combined hydrogen can be determined by comparing the pressure rise rates within an electrically isolated electrode to that within a cathodically poised electrode.

Applicability of the hollow palladium electrode will be tested in research melts of breeder composition that are subjected to varying over pressures of hydrogen and HF. The effects of trace oxide additions on such melts will also be studied. When the capabilities of the methods are established, experiments will be designed to study the distribution of protonated species in MSBR fuel salt the GSTF under realistic gas stripping conditions. When all possible data has been obtained with hydrogen and possibly deuterium, experiments with tritium will be performed to provide final evaluation of the method.

6.4.5.10 Subtask 5.1.1.10 Determination of oxide

The in-line determination of oxide is of prime importance since oxide could cause precipitation of protactinium and fissile and fertile materials from the fuel. The sensitivity requirement for in-line measurements will not be known until the oxide tolerance of the fuel is more accurately established but could be as low as 20 ppm. Voltammetric techniques respond to the activities of dissolved ions and are, therefore, unsuitable for the determination of total oxide if some of the oxide is present as a precipitate. Thus, sensitive electroanalytical methods would be of greatest value during normal operations at oxide concentrations below the tolerance level of the fuel and would complement rather than replace transpiration methods which would be applicable at the higher oxide levels. (Subtask 5.3.2.2).

In early experiments in MSRE solvent, a cathodic wave was observed that was attributed to the reduction of hydroxide to oxide and hydrogen, and an anodic wave resulting from the oxidation of oxide to oxygen. Further study of these waves was discontinued when it was found that they would be subject to interference by the reduction and oxidation waves of UF₄. Studies of voltammetry of oxygen-containing species will be performed in breeder fuel compositions. Techniques for resolving oxide waves from interfering uranium electrode reactions will be evaluated (digital processing and/or selective electrodes such as silver for oxide). If

direct electrochemical methods prove inapplicable, a combination technique will be developed, e.g., electrolysis of melts at controlled potential with sparging and measurement of liberated oxygen or oxygen compounds by gas analytical techniques.

For research studies in the breeder melts, it will be necessary to avoid atmospheric contamination more rigorously than was required for MSRE compositions. To this end dry box facilities are being upgraded with dynamic purification systems to reduce oxide and moisture concentrations to less than 1 ppm.

6.4.5.11 Subtask 5.1.1.11 Determination of niobium

Of the noble fission products, niobium is the most susceptible to oxidation. During the operation of the MSRE, major decreases in ^{95}Nb concentration were observed in the salt phase when adjustments of fuel redox potential were made by beryllium additions.⁵⁸ Thus, niobium merits electrochemical investigation, both to assess its potential as an auxiliary index of fuel redox potential in future reactors and to provide a tool for evaluation of MSRE data. Also, niobium may be used to modify the properties of Hastelloy N and thus could enter the fuel as a corrosion product. A rather extensive electroanalytical study of niobium was carried out in earlier research in MSRE solvents.⁵⁹ However, interference from traces of oxide in the melts prevented complete characterization. Electroanalytical studies of niobium will be carried out in breeder solvents, from which oxide contamination is more carefully excluded, to gain basic data and to assess the potential of the technique for in-line measurements. The effects of oxide additions at levels below the melt tolerance will be studied and limited measurements in MSRE compositions will be made for comparison and further understanding of MSRE experience.

6.4.5.12 Subtask 5.1.1.12 Determination of chloride

Chloride could enter the fuel via entrainment in bismuth streams from the rare earth removal step of the processing system. It is anticipated that chloride can be tolerated at low levels in the fuel salt, and its concentration will be limited by removal of chloride during the fluorination step. However, a method will be needed for determination of chloride in fluoride streams of the processing system. No measurements have yet been made, but the voltammetric oxidation of chloride ion to the element appears to be the most promising electroanalytical approach. An electroanalytical investigation will be carried out to determine whether a useful oxidation wave can be isolated from the possible interfering waves of UF_4 or oxide. Selectively active electrodes will be sought; and, if wave resolution proves impractical, the potential of a combination of electrolytic and transpiration techniques will be assessed. The effect of traces of chloride on the voltammetry of other ions in the fuel will also be investigated as a possible approach to in-line measurement.

6.4.5.13 Subtask 5.1.1.13 Studies of noble fission products

At anticipated conditions of normal reactor operation it is not expected that fission products more noble than niobium will be in ionic solution in sufficient concentration to permit electroanalytical measurement. Possible exceptions may be sub-zero oxidation states similar to those in the case of tellurium. Electrochemical studies will provide basic chemical information such as redox potentials and stabilized oxidation states under varying redox conditions. More practical information that will be gained will be the effects of such elements on analytical methods. The noble metals could deposit on electrodes and alter their characteristics or possibly cause electrode damage. A roughly analogous problem was encountered during voltammetric measurements in NaBF_4 coolant. Nickel, a relatively noble metal in this environment, formed an unexpected deposit on electrically isolated electrodes that prevented accurate voltammetric measurement of Fe^{3+} and active protons.

Basic electrochemical studies will be performed on a low priority for noble fission product elements in breeder fuel melts at various redox potentials. For those cases in which evidence of potential problems is obtained, such as anomalous stripping phenomena, plans for extended exposure of electrodes will be established, and the physical and electrochemical properties of the exposed specimens will be compared with those of fresh electrodes. The study will be extended to other noble trace elements that may be present either in the initial fuel or introduced by corrosion of special materials, such as precious metal brazing alloys, or transmutation products.

6.4.5.14 Subtask 5.1.1.14 Determination of transuranium elements and salt-soluble fission products

During the operating life of a power reactor, diverse transuranium elements and electropositive fission products can be present in fluoride streams of the fuel and processing systems in concentrations sufficient for measurement or detection by electroanalytical techniques. The concentration of some of these elements may increase throughout the operation of the reactor but many will reach a steady-state level as a result of removal by the processing system. There are at present no anticipated needs for the in-line measurement of these elements in an operating reactor, and if such a need arises many of them can probably be measured more effectively by γ -spectrometry (Task Group 5.5). However, detection of some of these materials may be required in the processing systems. Electroanalytical characterization studies will generate data to predict the electrochemical behavior of these elements and provide the necessary information for in-line support activities. A more important product of the basic studies will be to permit prediction of potential interference by these elements with essential in-line methods. Should voltammetric waves from such elements occur at potentials similar to those being measured at trace concentration levels, the accuracy of needed measurements could be compromised. The measurement of protactinium is

particularly vulnerable to such interference. In all likelihood, compensation can be made for moderate interferences by computer techniques but only if the interference is anticipated.

A survey will be maintained of all trace elements that could be present in the fuel at electroanalytically significant levels. Electroanalytical studies will be performed for such elements on a schedule that will be consistent with the needs of the Program. Unless special needs develop, this will be a low-priority activity. As more sensitive analytical methods are developed they will be used to scan samples of typical fuel and solvent preparations to determine whether other trace constituents should be included in this activity. Methods will be established to handle interferences that are discovered.

6.4.5.15 Subtask 5.1.1.15 Development of reference electrodes

A reliable reference electrode would offer several advantages to the in-line analysis program. For basic studies, a reference electrode based on a redox couple of established thermodynamic properties can be used for the direct estimation of free energies of formation of electroactive species in melts. A reference electrode of established reliability would make it possible to utilize direct potentiometric measurements instead of the voltammetric U^{3+}/U^{4+} ratio for the determination of redox potentials in the fuel and the required instrumentation would be simplified. Potentiometric methods would also be applicable to processing streams from which uranium has been removed. In such applications, a reference electrode would prevent the possibility of the misassignment of peaks as a result of abrupt changes in the potential of a quasi-reference electrode with redox conditions in the processing streams. It should be noted that other voltammetric features, such as melt limits, can serve as surrogates for a reference electrode, but excessive use of such "markers" can cause degradation of indicator electrode performance. The major problem in development of reference electrodes in fluoride melts is associated with the unavailability of compatible insulating materials that are needed to effect ionic contact between the melts and reference compartments. Installation requirements will also limit an in-line reference electrode to a small device of unit construction.

Reference electrodes for limited service have been fabricated using a boron-nitride membrane as a "salt bridge."⁶⁰ Devices that offer acceptably reproducible potentials for periods of months³² have been developed by using a single crystal lanthanum fluoride as an ionic conductor. In such devices the reference solution (a melt saturated with NiF_2) is contained in a cavity in the crystal and dissolution of the crystal by the salt is limited by contact with the salt through a metal frit. Problems with this electrode have included occasional cracking of the lanthanum fluoride, presumably under thermal stress, and difficulties, reported by others, in retaining the reference solution in the cavity.

Lanthanum fluoride reference electrodes will be installed in the GSTF for testing in breeder fuel under realistic conditions. In these tests, potentiometric response will be compared with values calculated from U^{3+}/U^{4+} ratios to establish the validity of the technique.

An analysis of the present reference electrode design will be made to devise modifications that will reduce stresses and ensure retention of the reference solution. As better insulating materials are identified, they will be incorporated into electrodes of improved designs. Existing and future electrodes will also be tested in melt compositions corresponding to processing streams.

6.4.6 Task 5.1.2 LiCl analyses

The metal transfer process will be used to remove high cross-section rare-earth fission products from MSBR fuel carrier salt after the removal of uranium and protactinium. This will involve the selective chemical reduction of materials from the fuel salt into liquid bismuth followed by back extractions into molten lithium chloride. In addition to the rare earths, the alkali-metal and alkaline-earth fission products and a number of the actinides will transfer to the LiCl. Also the use of this versatile system for actinide recycle may introduce additional constituents into the LiCl. Electroanalytical research in this area will be carried out to develop in-line methods to monitor the accumulation of constituents including corrosion products, uranium, thorium, fluoride, and actinide elements, in the lithium chloride. It is expected that the electrode insulator problem will not be as severe as that encountered in molten fluorides and therefore a more precise definition of electrode areas will bring about a significant improvement in the precision of voltammetric measurements. Further refinement of the data through pulsed voltammetric techniques and digital processing methods will be used to improve precision and sensitivity. In view of more pressing electroanalytical research needs for fuel and coolant salt analyses, the lithium chloride research is not expected to begin until FY 1978. In the meantime, the literature will be surveyed and pertinent information on chloride melts which has been reported by others will be utilized whenever applicable. Also, the requirements for analyses in this medium are speculative to a degree until further fuel processing studies are performed.

6.4.6.1 Subtask 5.1.2.1 Determination of uranium

During normal operation of the processing system, uranium will be largely removed upstream of the metal transfer process system by fluorination. Therefore, only trace concentrations of uranium will normally be present in the lithium chloride. The measurement of such concentrations may be needed for inventory purposes, for process controls, or for ensuring against losses of uranium. The uranium will probably be present as UCl_3 which should be measurable by anodic

voltammetry or perhaps chronocoulometry. Voltammetric techniques will be used to characterize the electrochemistry of uranium in chloride melts by measuring basic properties such as electrode reversibility, diffusion coefficients, stable valence states. When the electrochemistry of other species in lithium chloride has been studied, practical details for in-line analysis will be considered. This will include the application of pulse voltammetric techniques, digital methods for data processing and perhaps stripping techniques to provide resolution from adjacent waves and improve the sensitivity of the measurement.

6.4.6.2 Subtask 5.1.2.2 Determination of ionic corrosion products

Lithium chloride streams in the processing system may contain traces of the typical corrosion products (iron, chromium, and nickel) that have been transferred from the fuel, and also corrosion products from structural materials of the processing system. These latter materials may include molybdenum, tungsten, and tantalum, and perhaps diverse constituents from brazing alloys that may be used to join refractory metal components. Because the lithium chloride melts will be in contact with solutions of electro-positive metals in bismuth, the melts are expected to be quite reducing, and the concentration of ionic corrosion products will assuredly be low. A possible exception is sub-zero oxidation states that may be stable in these highly reduced melts. The studies in this subtask will not be restricted to reducing melts, however, because the electroanalytical methods may also be applied to the determination of total corrosion products after oxidation (see Subtask 5.1.2.7). Electrochemical characterization of these substances has not been carried out in lithium chloride. Others, however, have reported electrochemical measurements in similar melts, such as LiCl-KCl.⁶¹ Use will be made of this information wherever applicable when the lithium chloride research is under way. It is expected that separations and resolution of voltammetric waves will be comparable to that observed in the fuel salt. The electrochemical properties of anticipated corrosion product ions will be measured in melts of various oxidation potentials. Application will be made of anodic stripping or pulsed voltammetric techniques to provide improved sensitivities. In-line measurements on process streams will also be made whenever practical for screening purposes and for evaluation of the electroanalytical methods.

6.4.6.3 Subtask 5.1.2.3 Determination of thorium

The thorium which enters the lithium chloride will in large part be transferred to the waste streams. It will, therefore, be desirable to provide in-line methods for the measurement of thorium in the lithium chloride. The equilibrium concentration of thorium in the lithium chloride is expected to be quite low ($\approx 3.3 \times 10^{-6}$ mole fraction). It appears that voltammetric stripping or pulsed techniques have the greatest potential for this determination. First efforts will be to characterize the electrode reaction in molten lithium chloride in research melts; then work will be directed toward adapting the most promising techniques to in-line situations.

6.4.6.4 Subtask 5.1.2.4 Determination of plutonium

Plutonium will normally be removed from the fuel carrier salt in the protactinium reduction step and would not normally enter the lithium chloride stream. However, some carry-over may be expected, particularly when the processing system is used after start-up with plutonium as a fuel. The need for in-line measurements is therefore not thoroughly established, but sufficient characterization will be made to establish the basic electrochemistry of plutonium in lithium chloride and determine the feasibility of its measurement. No known electrochemical data exists in this area. Characterization will be done when appropriate alpha-containment facilities are available.

6.4.6.5 Subtask 5.1.2.5 Determination of fluoride

The presence of fluoride in lithium chloride streams of the processing system will increase the quantity of thorium that is transferred into these streams. In order to reduce thorium losses, it is desirable to control the concentration of fluoride at low percentage levels. The possibility of developing a fluoride ion specific electrode will be investigated. Single crystal LaF_3 (a fluoride ion conductor at high temperatures) will be used to construct a specific ion electrode provided its solubility in lithium chloride is not too high. Parameters to be delineated will be Nernstian response, response time, limits of detection, reproducibility of the potential measurements, and useful life times of the LaF_3 crystal in molten lithium chloride.

6.4.6.6 Subtask 5.1.2.6 Development of reference electrodes

Reference electrodes will be needed for basic electroanalytical studies in molten lithium chloride. Potentiometric measurements will provide a direct measure of the relative thermodynamic stability of electroactive species in this medium. A stable reference potential will also be needed for measurements of the potential of a specific fluoride ion electrode (Subtask 5.1.2.5) and for an oxide electrode (Subtask 5.1.2.8). The electrode may also be used to measure the concentration of certain electroactive species in the melt or in bismuth and to indicate divergence from equilibration between the salt and bismuth alloy. The two most commonly used reference electrodes in molten chloride are based on the silver-silver chloride and the platinum (II)-platinum couples. Electrodes based on these couples will be tested in synthetic melts at process temperatures. Electrodes suitable for in-line measurements will be developed and tested for various potentiometric applications.

6.4.6.7 Subtask 5.1.2.7 Determination of total corrosion products

It is anticipated that most of the corrosion products will be present in a reduced condition in the highly reduced chloride melts of the processing system. Except for the possibility of a few elements that may

possess soluble sub-zero oxidation states, most corrosion products will not be directly measurable by the electroanalytical methods. In-line electrolytic methods will be tested for the quantitative conversion of corrosion products to soluble ionic species. Chemical methods such as transpiration with HCl or chlorine will also be tested under Task Group 5.3. The most successful oxidation method will be combined with electroanalytical methods to provide a device for the in-line measurement of the total concentrations of individual corrosion products.

6.4.6.8 Subtask 5.1.2.8 Determination of oxide

The role of oxide in the metal transfer process is not yet thoroughly understood. Oxide layers are believed to have decreased the rate of transfer of materials between bismuth and salt in engineering experiments, and significant oxide could increase the corrosivity of lithium chloride and affect the distribution coefficients of certain metals between the salt and metal phases. It therefore appears likely that it will be necessary to monitor and control oxide concentration in the lithium chloride streams and an in-line method for the determination of oxides would assist such control. From thermodynamic considerations it appears unlikely that a voltammetric wave for uncomplexed oxides will be available within the working limits of lithium chloride melts. This assumption will, of course, be checked experimentally and a search for waves of oxide complexes such as oxianions will be made. It is likely, therefore, that potentiometric measurements will offer the most fruitful approach. Because it appears that ceramic materials will be less subject to attack in this medium than in the molten fluorides, the development of more conventional electrochemical cells should be possible. Approaches will include the use of selective ceramic membranes and the development of capillary or porous ceramic salt bridges between electrochemical half cells. Zirconia doped with calcium becomes an ionic conductor at high temperatures by virtue of mobile oxide ions and will be tested for application to a specific oxide electrode. Electrode couples reported to behave reversibly with respect to oxide ion in molten LiCl-KCl include Cu/Cu₂O, Pt/PtO, Pd/PdO and Bi/BiOCl.

The behaviour of these couples will be investigated in pure LiCl melts. The most favorable of these couples and the most practical means of developing ionic contact with the lithium chloride melts will be used to design an electrode in accordance with the usual requirements of unit construction for in-line application. Models of this electrode will be evaluated for parameters such as Nernstian response, response time, limits of detection, and reproducibility of potential measurements. When a satisfactory electrode appears to have been developed it will be subjected to long term exposures in research melts or in-line application to establish its reliability and useful lifetime.

6.4.7 Task 5.1.3 Coolant salt analysis

Currently, a large fraction of the electroanalytical research and development effort is being devoted to applications in the proposed eutectic coolant, $\text{NaBF}_4\text{-NaF}$ (92-8 mole %). These studies are primarily concerned with the development of methods for the in-line measurement of corrosion product ions and protonic species and with the establishment of the nature and properties of protonated species in the molten coolant. The measurement and control of protonated species in the coolant is of particular interest because of the potential use of the coolant for the containment of tritium. Studies of protonated species are of high priority because operation of the Coolant-Salt Technology Facility (CSTF) — the first major facility to be equipped with a suitable system for in-line electroanalytical measurements — is about to be resumed. One of the first experiments with this facility, the Deuterium Injection Experiment,⁶² is designed to provide definitive data on the effectiveness of fluoroborate for the containment of tritium that will be generated in the reactor fuel salt. In-line measurements will be needed to determine the distribution of deuterium which will be used as a stand-in for tritium. Materials compatibility studies will also be performed in this facility, probably concurrently with the deuterium experiments. In-line support of these activities will be provided by the electroanalytical measurement of corrosion product ions. Research and development studies will also be carried out in alternate coolant compositions that may be selected later. Many of the candidate coolant salts are expected to have similar properties to the MSRE fuel solvent in which extensive electroanalytical studies have already been made. Unless a really novel composition is selected as an alternate coolant, the required development studies will be limited to the measurement of essential constants such as diffusion coefficients, and the characterization of new constituents that may be incorporated into container materials. Therefore, no details for studies in alternate coolants will be projected for these subtasks.

6.4.7.1 Subtask 5.1.2.1 Determination of ionic corrosion products

As in fuel melts, in-line methods for the measurement of corrosion product ions, particularly Cr^{3+} , will be needed to monitor corrosion within the coolant system. The measurement of chromic ions in fluoroborate melts will be of even greater importance because of the rather low solubility of CrF_3 in this coolant. The concentration of Cr^{3+} must be limited to a value that will not permit the deposition of Na_3CrF_6 at the coolest region of the heat exchanger. Corrosion products of new alloying constituents (such as titanium, niobium, and cerium) that may be incorporated into the container material could also serve as effective corrosion indicators and will require investigation. Exploratory voltammetric measurements have been performed for Cr^{3+} , Fe^{3+} , Fe^{2+} , Ti^{3+} , and Ti^{4+} and further work will be required for complete characterization of these ions. Rather brief measurements during earlier operation of the CSTF demonstrated that voltammetric reduction waves could be recorded with acceptable reproducibility (~10 to 20 percent at the 30 to 100 ppm

level) for iron and chromium ions, and for a newly discovered wave that probably corresponds to the reduction of Mo^{3+} . The measurement of nickel was found to be impractical because of the low solubility of NiF_2 in fluoroborates. Although each of the waves is distinctly observable, quantitative interpretation of the waves from this multicomponent mixture of ions is difficult because early (more cathodic) waves contribute a significant but indeterminate current at the peak potential of the succeeding wave. Further measurements of individual ions and combinations of ions will be performed in research melts to obtain data for quantitative interpretation of voltammograms. Pulsed voltammetry and computer methods⁶³ will be tested for improving resolution of adjacent waves. In-line measurements will be performed throughout the operation of the CSTF to detect relative changes in the concentrations of corrosion products that result from various experiments and to provide data that can be interpreted more quantitatively after additional development work is completed.

6.4.7.2 Subtask 5.1.3.2 Determination of protonated species

Because of the potential value of the coolant salt for the containment of tritium, the measurement of protonated species in the proposed coolant salt is of primary importance. The monitoring of protonated species could also provide information on corrosion rates as a function of the concentration of protonated species and serve as a possible detection technique for steam generator leaks. We will continue investigating a unique electroanalytical technique that is specific for hydrogen. The method is based on the diffusion of hydrogen into an evacuated palladium tube electrode when the coolant salt is electrolyzed at a controlled potential. Both the amplitude of voltammetric waves recorded at the palladium electrode and the rate of increase of hydrogen pressure within the electrode are proportional to the concentration of an active protonated species, probably HF_2^- , in fluoroborate melts. The pressure measurement provides the greatest sensitivity. Standard additions to the 500 Kg of $\text{NaBF}_4\text{-NaF}$ coolant in the CSTF have demonstrated that active proton concentrations of a few parts per billion will produce a measurable pressure rise on electrolysis. An electrode of even better sensitivity will be needed to support deuterium injection studies.

The sensitivity of the active proton measurement will be increased at least tenfold by using an electrode of larger area that is coupled with an improved vacuum system and a more sensitive pressure measuring device. This improved system will be calibrated at the CSTF by standard addition techniques (standard additions at these low concentration levels are not practical for small research melts) and used in support of experiments in which deuterium will be diffused into the coolant. The vacuum system for the electrode will be designed in accordance with gas sampling requirements for Subtask 5.1.3.3.

6.4.7.3 Subtask 5.1.3.3 Determination of hydrogen and its isotopes

In order to evaluate deuterium injection experiments at the CSTF⁶² it will be necessary to distinguish between active protons and active deuterons in the melt. Similarly, the measurement of tritons will be required for later tritium injection experiments and for application to actual reactor coolants. In conjunction with Subtask 5.1.3.2 (Determination of protonated species), the palladium tube electrolysis technique will be extended to the determination of isotopic forms of hydrogen. This will be accomplished by applying counting and mass spectrographic methods to samples collected in the evacuated palladium electrode. This approach offers the advantage of specificity and applicability to in-line monitoring. When an in-line mass spectrometer becomes available, it will be tested in conjunction with an improved palladium electrode as a means for providing real time data for isotopic hydrogen measurements. Also, methods for the in-line measurement of tritium by internal gas proportional counting in flow-through cells will be studied. A further extension of the application of the palladium electrode will be to measure elemental hydrogen and its isotopes that are in solution in the coolant. This can, in theory, be accomplished by measuring the hydrogen that diffuses into an electrically isolated palladium electrode. The capabilities and limitations of this approach will be established in research melts that are subjected to an over-pressure of hydrogen. If adequate sensitivity can be obtained, this method will be used to measure the ratio of free and combined hydrogen and its isotopes during injection experiments at the CSTF.

A predominant fraction of the proton content of the fluoroborate coolant salt will be present as BF_3OH^- , a more stable species that does not reduce at the palladium electrode. Its potential role in the containment of tritium is not thoroughly established. Spectrophotometric evidence has shown that its proton does not readily exchange with deuterium that is diffused into molten fluoroborate but that BF_3OD^- is generated by oxidation reactions. It has been suggested that this species could be used to retain a major fraction of the tritium that diffuses into the coolant system.⁶⁴ At present the only established method for the measurement of BF_3OH^- involves the measurement of its infrared absorption at 3641 cm^{-1} , usually in a pellet pressed from pulverized samples. This is a lengthy empirical procedure and an in situ or in-line method would contribute greatly to the research and development studies on tritium containment. Anodic voltammetry will be investigated as a method for the determination of BF_3OH^- . A wave recorded on gold electrodes has been observed to vary in proportion to the BF_3OH^- concentration. This wave will be fully characterized and used to develop a method for measurements in the CSTF.

6.4.7.4 Subtask 5.1.3.4 Investigation of redox-buffer couples

In the reactor fuel, the $\text{U}^{3+}/\text{U}^{4+}$ couple provides chemical inertia that will prevent gross changes in redox potential from moderate additions of oxidants or reductants. To our knowledge no buffer of adequate

capacity is inherently present in the fluoroborate coolant. The incorporation of a suitable redox buffer into this or alternate coolants would make it possible to achieve better control of corrosivity and, perhaps, more effective containment of tritium. Voltammetric methods provide a very effective means for screening candidate redox couples by determining such properties as standard potentials and reversibility. Voltammetric studies will be used to characterize suggested redox couples for the coolant, such as $\text{Ce}^{4+}/\text{Ce}^{3+}$ and $\text{Ti}^{4+}/\text{Ti}^{3+}$. It should also be noted that the incorporation of a redox couple will permit a convenient measurement of the redox potential of the coolant.

6.4.7.5 Subtask 5.1.3.5 Development of reference electrodes

In electroanalytical measurements it is a distinct advantage to have an invariant reference potential to which the potential of other electrochemical reactions may be referred on a relative potential scale. The requirements for a reference electrode and problems associated with their applications to molten fluoride systems are discussed in Subtask 5.1.1.15. Reference electrodes are of even more importance in coolant salt systems than in fuel systems, because at present no suitable reversible couple is available to serve as a potential marker. Moderate success has been realized with an Fe/FeF_2 reference electrode in which the reference solution (coolant salt saturated with FeF_2) is contained in a single crystal of lanthanum trifluoride. Nernstian response was obtained for this electrode for EMF measurements on iron(II)/iron concentration cells. However, occasional cracking of the LaF_3 crystals was encountered. Consequently, further efforts will be made to develop more rugged ionic conductors. A practical reference electrode should be of unit construction and sufficiently rugged to function for in-line situations over extended periods of time. The present model reference electrode and any future improved assemblies will be used in the coolant in the CSTF to obtain practical experience.

6.4.7.6 Subtask 5.1.3.6 Determination of total corrosion products

Controlled-potential voltametry (Subtask 5.1.3.1) provides a measurement of only the soluble ionic corrosion products. Corrosion products may also be present as finely divided metals or as other insoluble forms. A more meaningful measurement of the cumulative corrosion of the coolant system would include the concentration of these non-ionic species. Methods will be developed for the in-line conversion of the total corrosion product content of coolant salt to soluble ionic species for electroanalytical measurement. Both electrolytic and transpirational oxidation procedures will be tested. The first such test will probably be made on isolated test portions of the coolant melt in the CSTF.

6.4.7.7 Subtask 5.1.3.7 Determination of oxygenated species

Additional information is needed on the behavior of oxygenated species in fluoroborate melts. For example, the solubility of $\text{Na}_2\text{B}_2\text{F}_6\text{O}$ in the coolant salt is not very well known and an understanding of the equilibria among the various oxygenated species and the fluoroborate coolant also awaits further study. Electroanalytical methods will be used to characterize and measure the electroactive oxygenated compounds. Efforts will also be made to develop an oxide ion specific electrode whereby the oxide ion activity could be determined from potentiometric measurements.

6.4.8 Task 5.1.4 Effects of radiation on electroanalytical transducers

Electroanalytical transducers will in general be subjected to intense beta and gamma radiation. Unless experiments to perform measurements within the core of an experimental reactor are implemented, exposure to neutrons will be limited to leakage and delayed neutrons and may be negligible at many locations. The effects of high beta and gamma radiation levels will be studied to assure that in-line instrumentation will function properly in the ultimate application. Earlier work has afforded only very limited opportunities to test electroanalytical methods in radiation environments. Measurements of the $\text{U}^{3+}/\text{U}^{4+}$ ratio in a sample of fuel withdrawn from the MSRE¹⁵ tend to support the feasibility of such measurements in radioactive environments. However, because of the necessary delays in transfer of the sample to a hot cell apparatus the activity of the sample had decayed by more than an order of magnitude. Also, the exposure was, perforce, of brief duration. It will therefore be necessary to predict areas of potential detrimental effect in order to design realistic exposure experiments that will establish the magnitude of these effects. Tentatively, the order of increasing probability of radiation effects would be damage to insulating materials for the penetration of electrode leads into the reactor system, damage to the noble metal electrodes themselves, damage to insulating materials that are exposed to the molten salt streams, and the effects on couples needed for potentiometric measurements. Separate programs of experimental exposure will be required in each of these areas.

Penetration insulators which are stable to radiation will be developed in other phases of the MSBR Program or in other reactor programs. The only need will be to select from such studies materials that will be compatible with the cover gas of the appropriate salt system and perhaps perform limited experiments to verify their performance in this application.

It is not expected that the noble metals will receive sufficient radiation exposure to cause unacceptable modifications of their structural properties since little stress is anticipated. Surface properties of voltammetric electrodes can exert a significant effect on their response that is not yet fully understood. For example, the operation of electrodes beyond melt limits for even brief periods can distort the shape

of voltammetric waves. In general, the damage from such excursions "heals" rapidly during normal operation of the electrodes. The continuous exposure of electrode surfaces to beta radiation could provide a continuous surface damage that would introduce errors if its effect is not predictable. The effects could, of course, be benign in some cases, but must be studied before the application of electroanalytical methods to actual reactor streams. An experimental program will be designed to determine the effects of radiation on various electrode materials and to select those materials least subject to damage. Because of the transitory nature of such phenomena it will ultimately be necessary to perform exposure tests during measurements in molten salts. Due to the expense of such experiments, screening tests will first be performed for various candidate electrode materials by exposing electrodes in available material test facilities, and then comparing the response of the exposed electrodes with those of virgin electrodes. Such tests may eliminate certain materials from further consideration. The remaining materials will then be tested under conditions of increasing severity of exposure. The first salt test will be performed in melts to which radiation energy is added as high-energy alpha emitters. These tests will not be realistic but can be performed within convenient alpha enclosures. Subsequent tests on materials that survive the alpha exposure will be performed with the addition of short-lived beta emitters in hot cells. Proper functioning during these exposures should be sufficient to establish the applicability to reactor systems. Measurements under in-pile conditions will be made if possible.

An insulating material which can simultaneously withstand exposure to salt and radiation would greatly assist the voltammetric measurements. It is not essential, however, because, with voltammeters of higher current capabilities and electrodes of appropriate geometrical designs, adequate definition of electrode areas can probably be achieved without insulators. A compatible insulating material will be required for the development of reference electrodes, however, a program similar to that suggested for the study of radiation effects on electrode materials will be used for the in-stream insulating materials. Work is now in progress to discover insulating materials of superior compatibility with non-radioactive molten salts. Those materials that prove suitable for this application will be screened by fairly simple radiation exposure tests that will detect deterioration of insulating properties under the influence of appropriate radiation at the temperature of the reactor streams. Materials showing promise will in turn be subjected to more strenuous tests to determine whether degradation will occur in molten salts to which radioactive isotopes have been added. These tests will be designed to determine whether an increased rate of dissolution or attack will occur as a result of the absorption of radiation energy. These tests will serve to select candidates for the fabrication of final models of reference and specific-ion electrodes for even more rigorous testing.

Reference electrodes which involve a chemical couple for potential measurements are possibly the most vulnerable to radiation effects. In addition to the materials problem that are described above, the introduction of radiant energy at these levels may be sufficient to affect the chemistry of the reference couples. Normally one would expect the radiation exposure to merely assure more rapid attainment of equilibrium potentials; however, at the anticipated radiation levels a steady state condition that deviates from equilibrium predictions could be generated. Models of these electrodes will be subjected on a gradient scale to conditions that ultimately approach or exceed those expected in reactor applications. This will include either in-pile testing in molten fuels or measurements in fuels that have quite recently been subjected to appropriate levels of neutron irradiation.

Wherever possible these radiation-effect studies will be performed in conjunction with other in-pile experiments that may be carried out by the Program, which will permit more economical testing and provide more realistic environments.

6.5 TASK GROUP 5.2 APPLICATION OF SPECTROPHOTOMETRIC METHODS

6.5.1 Objective

The objective of Task Group 5.2 is to develop spectrophotometric methods that will be useful for the analysis of fuel, coolant, and processing streams of test, demonstration, and power reactors, and to aid in the evaluation of the chemistry of such streams. The studies will be carried out on a schedule that will permit the use of such methods in support of research and technological studies of the MSBR development program. Spectral studies have been used to help establish the usefulness of the voltammetric uranium method, to aid in the identification of chemical species in molten fluoride salts, and to establish the nature of corrosion ion solute species.

Such studies, to date, have been on a batch-wise basis with only exploratory consideration of in-line analysis. The advent of tunable lasers, the development of suitable slotted optical probes, and the availability of experimental salt loops, will accelerate the development of methods for in-line spectral analysis.

6.5.2 Schedule

The schedule for work in the task group is shown in Table 6.5.2.

6.5.3 Funding

Operating fund requirements for this task group are shown in Table 6.5.3.1, and capital equipment fund requirements are shown in Table 6.5.3.2.

Table 6.5.2. Schedule for work in Task Group 5.2 - Application of spectrophotometric methods

	Fiscal year											
	1975	1976	1977	1978	1979	1980	1981	1982	1983	1984	1985	1986
5.2.1 Fuel salt analyses												
5.2.1.1 U ³⁺												
5.2.1.2 Total uranium												
5.2.1.3 Plutonium												
5.2.1.4 Protactinium												
5.2.1.5 U ⁵⁺												
5.2.1.6 Oxygenated species												
5.2.1.7 Turbidity												
5.2.1.8 Tellurium												
5.2.1.9 Diamond-tipped optical probe												
5.2.2 LiCl analyses												
5.2.2.1 Uranium												
5.2.2.2 Plutonium												
5.2.2.3 Oxide												
5.2.2.4 Hydroxide												
5.2.2.5 Transition metal ions												
5.2.2.6 Sapphire optical probe												
5.2.3 Coolant salt analyses												
5.2.3.1 BF ₃ OH ⁻ and BF ₃ OD ⁻												
5.2.3.2 Oxide												
5.2.3.3 Protonated species												
5.2.3.4 Corrosion product ions												
5.2.3.5 Redox buffers												
5.2.3.6 Optical probe												
5.2.4 Effects of radiation on optical components and spectra												

Table 6.5.3.1. Operating fund requirements for Task Group 5.2 — Application of spectrophotometric methods
(costs in 1000 dollars)

	Fiscal year											
	1975	1976	1977	1978	1979	1980	1981	1982	1983	1984	1985	1986
5.2.1 Fuel salt analyses												
5.2.1.1 U ³⁺	3	5	5	5								
5.2.1.2 Total uranium	2	5	6	8	10							
5.2.1.3 Plutonium			6	8	10							
5.2.1.4 Protactinium	3	5	5	7	10							
5.2.1.5 U ⁵⁺		3										
5.2.1.6 Oxygenated species		3	3	5	7	10						
5.2.1.7 Turbidity			5	5	5	10		10	10			
5.2.1.8 Tellurium	2	4										
5.2.1.9 Diamond-tipped optical probe		3	5	5	7							
Subtotal 5.2.1	10	28	35	43	49	20		10	10			
5.2.2 LiCl analyses												
5.2.2.1 Uranium				2	4							
5.2.2.2 Plutonium				2	4	10						
5.2.2.3 Oxide					4	10	10					
5.2.2.4 Hydroxide						6	10	15				
5.2.2.5 Transition metal ions				2	4	6	10	15	10			
5.2.2.6 Sapphire optical probe					2	5	10					
Subtotal 5.2.2				6	18	37	40	30	10			
5.2.3 Coolant salt analyses												
5.2.3.1 BF ₃ OH ⁻ and BF ₃ OD ⁻	10	5	3									
5.2.3.2 Oxide	2	5	4	3								
5.2.3.3 Protonated species			3	3	7	8	12					
5.2.3.4 Corrosion product ions			3	3	5	5	5	10				

Table 6.5.3.1 (continued)

	Fiscal year												
	1975	1976	1977	1978	1979	1980	1981	1982	1983	1984	1985	1986	
5.2.3.5 Redox buffers				2	4	5	6						
5.2.3.6 Optical probe		5	7	5	5	5	8						
Subtotal 5.2.3	12	15	20	16	21	23	31	10					
5.2.4 Effects of radiation on optical components and spectra							5	20	60	50	40		
Total operating funds for Task Group 5.2	22	43	55	65	88	80	76	70	80	50	40		

Table 6.5.3.2. Capital equipment fund requirements for Task Group 5.2 -
 Application of spectrophotometric methods
 (costs in 1000 dollars)

	Fiscal year								
	1975	1976	1977	1978	1979	1980	1981	1982	1983
5.2 Miscellaneous items	6	27	26	25	4		30	20	
5.2 Inert atmosphere alpha box				28					
5.2 Carey spectrophotometer						45			
5.2 Tunable ultraviolet laser						30			
Total capital equipment funds for Task Group 5.2	6	27	26	53	4	75	30	20	

6.5.4 Facilities

Most of the basic studies and initial development efforts will be performed in existing facilities of rather modest requirements (analytical laboratories with standard hoods). For work in radioactive melts, space and facilities are available at the Transuranium Laboratory or the Analytical Chemistry Hot-Cell Facility in Building 3019. Engineering installations in which in-line measurements are to be made will also serve as facilities for this task because the in-line measurements made therein may uncover practical deficiencies in the methods. In addition, installations containing large quantities of salt sometimes present opportunities for stability studies and calibrations that are not feasible in small research melts. Application of in-line spectrophotometric methods to engineering facilities is expected to be more limited during the early stages of the Program because the installation of optical devices will require more extensive modification of the equipment than will electroanalytical probes. Initial demonstration of in-line spectrophotometry may be made in the Analytical Test Facility (Task Group 5.6).

6.5.5 Task 5.2.1 Fuel salt analysis

Research and development studies carried out to date have been directed toward the characterization and identification of solute species of interest, and to the assessment of the potential of spectrophotometry for their determinations. These studies have led to identification of important solute species, to an understanding of the coordination of transition metal and actinide ions in these solvents, and to the analytical determination of several solute species, including uranium. A review of this basic research is given in Section 6.3.3.2. It is expected that a strong emphasis on fuel analysis will continue throughout the early stages of the program until materials problems are resolved. Our earlier work was performed in melts of MSRE solvent composition and many of our measurements, particularly spectral sensitivities, will have to be repeated in the thorium-bearing MSBR fuel salt.

It is important to carry out both spectral studies and electrochemical studies (Task 5.1.1) of solute species in MSBR melts. These two different types of studies augment each other in that they yield mutually beneficial information derived from different characteristics of the ion in question. Also, each technique is vulnerable from different interferences since the measured characteristic is different. Electrochemical studies are more easily adapted to in-line measurements, but, in general, they yield indirect or inferred results. Spectroscopy has proceeded, on an experimental and theoretical basis, to a stage where it can yield direct results as to the identity, coordination, and concentration of amenable species (in general, transition metal ions). At the present state of the art, spectral studies can be carried out on very small volumes of sample — thus permitting the characterization of rare or hazardous materials. There are times when a comparison measurement of both chemical activity, by electrochemistry, and chemical concentration,

by spectroscopy, would be of benefit. In general, spectral measurements can be made with more precision so that overlapping absorption peaks can be resolved; computer techniques can be and have been applied to such data treatment.

Spectral techniques were applied to samples of fuel from the MSRE to determine the presence of U^{3+} in remelted samples and to demonstrate that U^{3+} was formed radiolytically when MSR fuel was allowed to stand at temperatures below $200^{\circ}C$ for periods of days. The measurements were carried out with great difficulty in a hot cell. Tunable lasers of rather wide wavelength are now available, and such measurements will be much easier. Throughout all the individual spectral studies to be performed, the application of tunable laser light sources with improved in-line spectral devices will be evaluated for ultimate application to the analysis of molten salt streams. As soon as these improved systems are developed and appropriate modifications are made to technology facilities, in-line measurements will be started both to provide improved analytical data and to establish capabilities and limitations of the method. The requirements for in-line spectrophotometric analyses will, in general, be the same as those that were delineated for in-line electroanalytical measurements (Task Group 5.1) and will not be discussed in detail in the following subtasks. Spectrophotometric analyses of discrete samples will continue to be performed when needed by the Program.

6.5.5.1 Subtask 5.2.1.1 Determination of U^{3+}

Further evaluation of the spectral determination of U^{3+} will be made with regard to establishing the sensitivity and molar absorbance index (A_m) of the analytically useful absorption peaks for U^{3+} in MSBR fuel solvents. Previous work has been done mainly in MSRE type solvents. The precision of these spectral measurements will be established by the use of the diamond-windowed spectral cell. Another critical area of investigation is in the methodology of sample transfer.

Previous spectral determinations of U^{3+} , in which a sample had to be transferred from an experimental facility to a spectral cell, has shown that reliable values can result, but that the transfer is very critical. This area must be further studied so that the parameters affecting sample transfer are clearly defined. A comparison of spectral and electrochemical results with variation of transfer procedures will be made. As a result of these studies, a rather precise procedure for general sample transfer will be developed.

The absorption peak of U^{3+} at 360 nm is one of the stronger observed in fluoride melts ($A_m \sim 800$). Spectrophotometric measurements could therefore be competitive with electroanalytical techniques in the measurement of total uranium in reduced streams of the processing system. The capabilities of such measurements for the determination of uranium in effluents from reductive extraction processes will be evaluated.

6.5.5.2 Subtask 5.2.1.2 Determination of total uranium

The measurement of small variations in the concentration of uranium in fuel is necessary to ensure nuclear stability in the operation of molten salt reactors. During the operation of the MSRE, it was demonstrated that reactivity balance measurements were capable of detecting short term changes in uranium concentration much more precisely than existing methods of chemical analysis. In the case of a breeder reactor, however, concurrent decreases in the concentration of uranium and thorium would have opposite and cancelling effects on reactivity; moreover, the removal of fission products will complicate the calculation of a long-term reactivity balance. Thus, the value of reactivity measurements for determining uranium concentration could be compromised and a highly reproducible method will be needed for the direct in-line measurements at the required precision. Calculations have indicated that in a one-cm path of fuel the absorbance of the U^{4+} peak in the near infrared (1090 nm) can be measured with a reproducibility of about 0.1 percent. Absorption by other ions that have been measured is minimal in this region. The achievement of such reproducibility would require a precisely defined optical path that could be obtained with a diamond-windowed optical cell or a slotted probe (Subtask 5.2.1.9) and either the oxidation of all of the uranium to U^{4+} or a correction for the small fraction of U^{3+} in the fuel. It should be emphasized that the accuracy of these measurements will depend on calibration and will not necessarily match the precision.

In theory, the reproducibility could be further improved by at least an order of magnitude by the use of high-intensity light from a tunable laser to permit measurements through longer path lengths or by more precise measurement of transmitted light from an isotopically excited source. The achievement of the theoretical potential for practical monitoring systems would require stringent measures to control experimental variables, such as temperature and vibration, and to apply corrections for variations in the concentration of even weakly absorbing ions, for turbidity, and for effects of melt composition on the intensity of uranium absorption. With digital data processing and careful design of transducers such extreme precision appears feasible, and a significant development effort is justified because of the value of assurance of fuel stability during reactor operations.

The practicality of high-precision spectrophotometric measurements will be assessed in more detail by examining measured or predicted spectra of ions that may be present in sufficient concentration to affect the measurements at 1090 nm, repeating measurements of the absorption spectra of selected ions, estimating the effects of turbidity, and analyzing experiments that are conceived to demonstrate the feasibility of the method. Until a tunable laser and perhaps an in-line probe are available, spectral measurements of U^{4+} will be limited to basic studies of changes in intensity of absorption and peak shapes with variations in composition in the region of the reference fuel mixture. Some of these data are available from earlier research studies.⁶⁵ When appropriate equipment is available, measurements will be made, probably in

the Analytical Test Facility, under conditions predicted to yield a reproducibility of about 0.1 percent. The experimental data will be compared with the theoretical predictions and any deviations will be subjected to error analysis. Calculations will then be performed to predict the requirements for extending the technique to any preselected level of reproducibility and to estimate the development cost incurred. On the basis of recommendations from reactor physics and safety groups, a target precision will be established and the necessary development work will be performed to provide a device for testing in the GSTF or another equally appropriate facility.

Other areas where total uranium needs to be determined are in waste and process streams and in the salt effluent from the fluorination facility. These measurements are necessary for precise inventory control and will be applied to streams that should contain no uranium or, at most, a very low concentration of uranium. By making use of a very sensitive ultraviolet peak of U^{4+} , at 235 nm, it should be possible to detect <10 ppm of uranium. This absorption peak of U^{4+} falls outside the transparency range of diamond, therefore windowless cells must be used for this application. Work directed toward proper cell geometry and assessment of ultimate sensitivity will be carried out. In the reductive extraction process streams, small amounts of U^{3+} will be determined, as discussed in Subtask 5.2.1.1.

6.5.5.3 Subtask 5.2.1.3 Determination of plutonium

The spectrophotometry of plutonium compounds in breeder compositions will be studied to provide data for the development of analytical methods and to contribute to the basic understanding of the chemistry of plutonium in this medium. Preliminary absorption spectra for Pu^{3+} in molten fluoride salts⁶⁶ exhibit a complex pattern with a wide variation of absorption intensities. It appears that absorptiometric methods should be feasible both for the precise measurement of high concentrations of PuF_3 that would be present during start-up with plutonium fuel and for trace concentrations generated by nuclear reactions. There appears to be no immediate need for in-line analytical methods for plutonium. Basic studies will be carried out as soon as practical, however, to determine whether its presence may interfere with the determination of other constituents.

6.5.5.4 Subtask 5.2.1.4 Determination of protactinium

Control of the concentration of protactinium is necessary for attaining a high breeding ratio in the reactor. The equilibrium level of protactinium will be too low to be determined in the presence of uranium. However, the spectral determination of protactinium will be evaluated for application to salt streams in the processing system which contain lower concentrations of uranium. Some preliminary spectral studies of Pa^{4+} have been completed. Based on these studies, it should be possible to determine Pa^{4+} in processing streams or other fluoride melts of

interest down to a concentration of less than 50 ppm. It may be possible to extend this limit to lower concentrations as further studies are carried out.

The precision and sensitivity of the spectral determination of Pa^{4+} will be evaluated for in-line measurements with improved spectrophotometric techniques. Capabilities of the spectral methods will be compared with those of electroanalytical methods in similar applications. A search will also be made, in melts that are carefully freed of oxide, for ultraviolet absorption of Pa^{5+} . Sensitive Pa^{5+} determination would support basic studies of the chemistry of protactinium.

6.5.5.5 Subtask 5.2.1.5 Determination of U^{5+}

The absorption spectrum of UF_5 has been measured in MSRE fuel solvent.⁶⁷ The spectrum includes a sharp peak at 1465 nm that is sufficiently intense for the measurement of moderate concentrations of U^{5+} in fluoride melts. The spectrum will be remeasured in melts of breeder composition, using diamond-windowed cells to provide improved accuracy for absorptivity measurements. These calibration measurements will be used to provide analytical support for fuel reconstitution studies. Devices for in-line measurement will be developed if needed.

6.5.5.6 Subtask 5.2.1.6 Determination of oxygenated species

An understanding of the chemistry of traces of oxide in fluoride melts is of recognized importance to the stability of reactor streams and to possible alternate processing schemes. It is probable that oxide can exist in several forms in the fuels, such as O^{2-} , OH^- , MO_n^{y-} , etc. The complete evaluation of the possible interactions of oxide ions requires a knowledge of the type of oxygenated species that are present. Studies in this area could also lead to new analytical approaches to the important measurement of oxide activities in MSBR streams. If a strongly absorbing oxygenated species is found to be in equilibrium with oxide ions, its measurement could provide the basis for an in-line spectral method for the measurement of oxide activity. Also, the determination of trace elements by spectral and other techniques could be affected by the formation of oxide complexes. The reaction of chromium (VI) and vanadium (V) with oxide to form the strongly absorbing chromate and vanadate ions will be evaluated as a method for the determination of uncomplexed low level O^{2-} , or total oxide. The extraction of OH^- into molten NaBF_4 will be studied. Once extracted, the hydroxide will be determined by the infrared pellet technique (see Subtask 5.2.3.1). Infrared spectra of oxygen-containing melts will be examined for useful absorptions. Much of the exploratory work will be done in melts that contain no thorium so that meaningful standard additions can be made without exceeding the oxide tolerance. Any promising approaches will then be studied in MSBR fuels for possible in-line applications.

6.5.5.7 Subtask 5.2.1.7 Measurement of turbidity

Some turbidity is expected in reactor fuel and within other salt streams of molten salt reactors. Because no provisions for optical observation of the fuel were available at the MSRE, no estimation of the degree of turbidity of circulating fuel can be made. It will be necessary to perform experiments to obtain estimates of the sources and magnitude of turbidity so that its effect on spectrophotometric and other in-line optical methods can be predicted. Also, an in-line measurement of turbidity could provide useful information in various areas of reactor operations. It has been inferred (from the relatively stable concentrations of the more noble corrosion products, iron and nickel, in MSRE fuel that was sufficiently reducing to preclude their presence in ionic form) that these materials are present as particulate metals of submicroscopic size.⁶⁸ Particles in this size range could cause significant attenuation in the ultraviolet transmission of the fuel and thus interfere with measurements in this region of highly intense absorptions. Interference at longer wavelengths with important determinations such as the precise determination of uranium (Subtask 5.2.1.2) could be introduced by bubbles of helium and graphite particles. If the effect of turbidity is low, an empirical correction that is correlated with a measurement of light scatter would probably suffice. More serious interference could be handled either by characterizing the scattering material and computing its contribution to the attenuation, or by pretreatment of the streams to reduce turbidity. This could be accomplished by filtration, settling, or chemical oxidation.

Many additional benefits could result from the optical characterization of particulate matter in reactor streams. The most obvious is the direct measurement of the concentration and size distribution of helium bubbles to assist in achieving optimum stripping of the high cross-section ^{135}Xe . A rather complete characterization of the total particulate matter in salt streams would provide a new parameter for the evaluation of reactor operation. For instance, it could provide early warning of precipitation of fuel constituents by known or unexpected routes. It should be emphasized that since light scattering techniques involve a direct rather than a subtractive measurement they can be used to provide some of the most sensitive of optical measurements. The sensitivity is primarily a function of the intensity of incident light. In a thermally stable medium such as molten salts, detection limits could be extended to almost any desired level by using lasers as a source of incident light. A fruitful area for this type of measurement would be in the study of the generation of dispersions of bismuth metal during reductive extraction steps of processing. If particulate matter that is originally present in the entering steam is largely removed by reductive extraction, or if bismuth particulates possess some optically distinguishable characteristic, scattering measurements could be applied to a sensitive method for the essential in-line measurement of bismuth in return streams. Scattering techniques could readily be applied to the measurement of particulates in cover gases. In this instance the streams could be diluted to a concentration that would permit the measurement of scattering by individual particles.

Initial turbidity measurements will be made by using the viewing ports that are to be installed on the salt monitoring vessel of the GSTF. Although the geometry of this system will severely limit the scattering angle, these data should be adequate to estimate the order of magnitude of interference to absorptiometric measurements to be expected from particulate metals and the relative contribution of helium bubbles to the turbidity of fuels. When a tunable laser is available, measurements of scattering at different wavelengths will be used in this facility to crudely estimate particle size distribution. More definitive experiments will be made in turn of the size distribution of particulate metals that are generated by the reduction of research melts or of the fuel in the Analytical Test Facility. It is anticipated that a number of more convenient and sophisticated devices for particle size classification will be generated by programs concerned with pollution abatement. These developments will be appraised for applicability to molten salt measurements. In general, techniques that utilize wavelength and polarization parameters rather than angle of scatter will be selected because of their applicability to simplified cell designs. Practical in-line cells will be developed and used to characterize particulate matter in fuel and processing streams of various test facilities. From the data obtained, computer programs will be developed to generate turbidimetric corrections for spectrophotometric data.

6.5.5.8 Subtask 5.2.1.8 Study of tellurium in fuel

On the basis of our present knowledge it does not appear that the concentration of tellurium in MSBR melts will be sufficient for measurement by spectrophotometric methods. It has been established previously that the species Te_3^- can exist under isothermal conditions in MSRE fuel solvent melts.⁶⁹ Further studies of this species and of other oxidation states of tellurium, e.g., Te^{2-} , Te_2^{2-} , and Te^0 , will be made in breeder fuel solvent to establish their possible existence, spectral characteristics, and solution chemistry. Possible reaction routes leading to the controlled removal of Te_3^- ions from these melts will also be investigated. This work will be coordinated with basic chemical investigations of tellurium chemistry (see Section 5) in order to provide analytical support when needed.

6.5.5.9 Subtask 5.2.1.9 Development of a diamond-tipped optical probe

The simplest system for in-line spectral analyses of molten salt reactor streams would incorporate an optical probe. With proper optical design, a light beam could be directed into and out of a molten salt stream through only one penetration. Light would be transmitted within the probe by internal reflectance. The probe would be slotted to allow the light beam to pass through a known length of the molten salt. The probe material must be transparent, of high refractive index, and compatible with molten salts. A diamond-tipped optical probe would meet these requirements for the fuel salt, and studies leading to the fabrication and testing of such a device

will be carried out. A more detailed description of the principles of optical probes is presented in Subtask 5.2.3.6.

6.5.6 Task 5.2.2 LiCl analysis

Spectral characterizations leading to in-line analytical methods will ultimately be performed for the various solute species expected to be present in molten lithium chloride streams of the processing system. Except for requested analytical support studies, active investigations in this medium will be deferred because of more urgent problems in other areas. This should actually lead to more effective utilization of the research and development resources since research in the less hostile chloride media will provide much of the needed data and the analytical requirements will be more thoroughly established after additional engineering experiments. Spectral investigations will yield the same type of useful information as direct analyses of solute species in molten lithium chloride as described in the fuel analysis section (6.5.5, Task 5.2.1), but with easier application.

6.5.6.1 Subtask 5.2.2.1 Determination of uranium

It is expected that uranium compounds in lithium chloride will exhibit strong absorptions that can be used to develop in-line methods of competitive sensitivity with electroanalytical methods. The spectra of uranium in various oxidation states will be characterized to determine basic chemical data such as coordination, and the applicability of spectral methods for the in-line monitoring of uranium transfer into the lithium chloride process streams.

6.5.6.2 Subtask 5.2.2.2 Determination of plutonium

Measurable concentrations of plutonium may enter the lithium chloride phase particularly during initial processing for a reactor that was started up on plutonium fuel. It is anticipated that PuCl_3 will exhibit a strong and complex spectrum that can prove useful for spectral measurements and may offer interferences to other spectral determinations. Spectral characterizations of the various stable oxidation states of plutonium in lithium chloride melts will be made to assess the potential for its in-line determination and its effect on other analyses.

6.5.6.3 Subtask 5.2.2.3 Study of oxides

Significant concentrations of oxide in molten lithium chloride are expected to limit the rates of transfer of fission products between bismuth and halide streams. For this reason, and because oxide may attack structural materials, the chemistry of oxide in lithium chloride will have to be studied. The most promising spectral approach will be

to search for intensely absorbing oxycomplexes that may be formed by the reaction of oxide with a solute that is normally present in the processing streams or with some innocuous added solute. A systematic survey of the absorption spectra of various solutes in oxide-bearing lithium chloride will be conducted throughout the range of spectral transmission of this medium. The most useful absorptions will be characterized more fully for applications to in-line measurements. If it proves necessary to add a solute to develop oxide absorbancies, the stability of this solute in process streams and its potential effect on the reactor system will be evaluated. The measurement of absorptions in solid samples will also be investigated.

6.5.6.4 Subtask 5.2.2.4 Study of hydroxide

Hydroxide in molten lithium chloride would cause corrosion of structural metals and many ceramic materials that might be used in the fabrication of analytical devices. Unless it is continually replenished, it appears likely that the concentration of uncomplexed hydroxide in chloride processing streams will be decreased to levels below spectral detection limits through reduction by the bismuth streams. Therefore, the initial activities in this task will be directed towards the development of highly sensitive methods for the determination of hydroxide in samples of lithium chloride. Methods based on infrared absorption appear to be the most promising. These will be tested both for the measurement of hydroxide that has been preconcentrated by extraction into immiscible NaBF_4 melts and for the measurement of solid state hydroxide complexes in pressed pellets. If unusually sensitive solid state absorptions are discovered, a search will be made in melts for similar absorptions that could serve as a basis for in situ determinations.

6.5.6.5 Subtask 5.2.2.5 Study of spectra of transition metal ions

The spectral characterization of diverse transition metal ions in lithium chloride melts will provide basic chemical data and information for possible analytical applications for this medium. It is anticipated that the intensity of absorptions resulting from d-d transitions will be significantly enhanced in this melt; therefore, useful analyses of ions such as corrosion products will be possible although mutual interferences may also be accentuated. Because actinides may be present in these processing streams during special operations of the processing system, their ions will also be measured. Spectral studies will be performed as time permits of all such ions that may be present in the lithium chloride streams with particular attention to lower oxidation states. Related studies by others have been made in similar but not identical melts. Missing information will be gathered experimentally and an assessment of analytical capabilities will be made.

6.5.6.6. Subtask 5.2.2.6 Development of a sapphire optical probe

As described in more detail in Subtask 5.2.3.6, a simple optical probe would offer significant advantages for practical spectral measurements in lithium chloride melts. It is expected that synthetic sapphire, which has suitable optical properties, will be compatible with molten lithium chloride. Design, fabrication, and evaluation of such a probe for spectral analysis will be made.

6.5.7 Task 5.2.3 Coolant salt analysis

The highest priority for research and development studies under this subtask will be assigned to the generation of methods to support imminent experiments at the CSTF that are designed to evaluate the potential of the NaBF_4 coolant for the containment of tritium (cf. Task 5.1.3). Immediate efforts will be concentrated on urgently needed methods for the spectral analysis of discrete samples rather than the longer term objective of providing in-line analyses. Priority will also be granted to spectral support of associated development efforts of other areas of the Analytical Chemistry Research and Development Program, such as the identification of condensate from the cover gas of the CSTF (Subtask 5.3.1.3). Information gained in these developments will, in turn, be applied to in situ studies of proton chemistry in fluoroborate melts and to the development of in-line methods that will ultimately be needed for a more efficient analytical system. Other solutes, such as oxide and redox buffer couples, of possible significance to tritium containment will be studied on a lower priority basis. When alternate coolants are proposed, spectral methods will be applied to generate basic chemical data on solutes in these materials and to provide any needed analytical support for their evaluation.

6.5.7.1 Subtask 5.2.3.1 Determination of BF_3OH^- and BF_3OD^-

The present analytical investigations indicate that the major fraction of combined hydrogen in NaF-NaBF_4 coolant melts is present as the relatively stable BF_3OH^- ion, typically in concentrations of about twenty ppm as hydrogen. In the reference reactor design this concentration corresponds to a quantity of hydrogen that is comparable to the total tritium production during the operating lifetime of an MSBR reactor. Therefore, it will be of major interest in the deuterium injection experiment at the CSTF to determine whether deuterium, a stand-in for tritium, can be incorporated into the hydroxyfluoroborate ion. The only established method for distinguishing between hydrogen and deuterium in this compound is the infra-red pellet technique.⁷⁰ At present, the detection limit (established by standard additions of NaBF_3OH) is about one ppm. Essentially identical sensitivities are predicted⁷⁰ for the measurement of BF_3OD^- . At least an order of magnitude improvement in detection limit will be needed to evaluate the results of the deuterium

injection experiments. The use of thicker pressed pellets will be investigated as a means of improving the sensitivity of the infra-red method. These development studies will also provide verification of the calibration for BF_3OH^- measurements because standard additions of deuterated compounds can be made without contamination. The techniques developed will also be used in support of basic chemical studies on the control of BF_3OH^- concentrations in melts. Studies of the direct infra-red measurements of these ions in melts will be resumed to evaluate this approach for the development of in-line analytical methods.

6.5.7.2 Subtask 5.2.3.2. Determination of oxide

Uncomplexed O^{2-} ion may not exist in NaBF_4 . Many oxides, however, readily dissolve in this melt and the nature of the dissolved oxide species must be characterized in order to assess their effect on corrosivity and possible modes of tritium transport through the coolant salt. For these types of studies, infrared analyses of molten and solid NaBF_4 will be used to establish the molecular species that are present. Similar investigations will be performed on alternate coolant compositions which may be proposed during the course of the program.

6.5.7.3 Subtask 5.2.3.3 Determination of protonated species in alternate coolants (AC)

As other coolant melts are developed to an experimental stage, an assessment of their interaction with tritium escaping from the fuel salts will need to be investigated. These considerations will require a knowledge of the type and concentration of protonated species that are present in the melt. Molecular spectroscopy, using infrared or near-infrared measurements, will be applied in these studies. Recent research⁷¹ has shown that infrared measurements can be used to measure complexes of anions including hydroxides with di- and trivalent cations at ppb concentrations. This solid measurement technique will be applied to the characterization and determination of protonated species in the new coolants, and possible extensions to direct measurements in melts will be studied. Methods developed in this subtask will be used to provide analytical support for experiments to study the exchange capabilities of protonated species with deuterium or tritium.

6.5.7.4 Subtask 5.2.3.4 Determination of corrosion product ions

Earlier investigations of typical corrosion product ions, such as Fe^{2+} , Ni^{2+} , and Cr^{3+} , have shown that their absorbancies are too weak for profitable exploitation for in-line analytical methods in the present MSBR coolant. Also, in the NaBF_4 coolant the solubilities were too low to permit proper spectral characterization. It is assumed that the spectra will be similar in alternate coolant compositions provided they are made up of fluoride salt mixtures. Spectrophotometric studies will

be needed for these ions and those of other components of structural alloys to provide basic chemical information and to predict possible interferences with other spectral determinations. Characterization of these species will be made in melts of proposed alternate coolants. Also, the spectra of certain fuel constituents will be studied for potential application to the detection of leaks in heat exchangers during periods of initial non-nuclear operation.

6.5.7.5 Subtask 5.2.3.5 Study of redox buffer candidates

For any MSBR coolant salt it will probably be desirable to incorporate some type of redox buffer system to control corrosion or assist in tritium containment. In general, these redox couples will involve multi-valent solute species of transition metal ions, and one or both of the oxidation states will be amenable to spectral determinations. Spectral studies of proposed redox couples will be made to characterize the nature of both solute species and to assess spectral methods for an in-line determination of the redox condition of the coolant.

6.5.7.6 Subtask 5.2.3.6 Development of an optical probe for coolant salts

The application of spectrophotometric methods to molten salt streams can be performed much more conveniently if both the entrance and exit beams can be conducted through a single penetration. For this purpose, a simple optical device has been developed that is generally applicable to all fluid streams for which a suitable optical material exists.³⁹ The optical material must be compatible with the fluid to be measured and must have a higher refractive index. The device is fabricated from a cylindrical section of optical material for convenient sealing into the system. Facets ground onto the external end of the material direct a collimated beam of light (typically from a tunable laser) along a longitudinal path in the probe and provide an exit window for the attenuated exit beam. A prismatic configuration at the immersed end of the section reverses the direction of the beam by total internal reflection. A slot of appropriate length, cut to intercept one of these light beams, contains the fluid and provides an invariant path length for absorptiometric measurements. This device was conceived when it was found that single crystal lanthanum fluoride — an optical quality material available in massive shapes — was a suitable window material for spectrophotometric measurements of at least limited duration in fluoroborate coolant melts. Plastic mockups of such a device have been tested with aqueous systems and found to give accurate absorbance measurements. More recently, slightly more complex designs have been conceived that will effect simultaneous measurements of absorption and scattering. Composite modifications will permit use of smaller quantities of optical materials (see Subtask 5.2.1.9, Development of a diamond tipped optical probe). Lanthanum fluoride is being obtained to fabricate a probe for tests in molten coolant salts. These tests will provide information for general use of this technique in coolant salt streams.

6.5.8 Task 5.2.4 Effects of radiation on optical components and spectra

Many of the in-line spectrophotometric measurements for an MSBR will be performed in the presence of intense beta and gamma radiation and perhaps moderate neutron fluxes. It was demonstrated by measurements of remelted MSRE samples that meaningful spectral information could be obtained for highly radioactive molten salt samples; however, because of unavoidable delays, the activity of these samples had decayed to a level at least two orders of magnitude below that anticipated during in-line applications. Methods for the elimination of the possible interference from Cherenkov emissions will be established for these applications. The possibility that other optical emissions can be stimulated by the intense radiation in the fuel will also be considered. Should such emission be possible it will be evaluated as an interference to analytical methods, and then studied further as a separate investigation for possible analytical usefulness in the area of general or specific fuel characterization. Measurements will be made of transient and long-term effects of radiation on the transmission of diamond windows that will be used for the most precise measurements (cf. Subtask 5.2.1.2). Less rigorous measurements will also be made for other proposed optical components including other probe and window materials and materials for containment windows. Those materials that will be exposed to the salt will be tested under simultaneous exposure to both radiation and molten salts. Some of these studies may be carried out in conjunction with tests of insulating materials for electroanalytical measurements. Effects of radiation on optical sources and detectors will also be evaluated. It is planned to use collimated beams from tunable lasers so that these components can be located outside areas of intense radiation; however, close mechanical coupling of optical elements may be required to minimize vibration effects.

The capabilities of spectral methods for measurement of minute samples will be used to study the effects of radiation on the chemistry of fuel melts. Such measurements will be needed to predict effects on in-line analytical determinations by spectral and other techniques and will provide basic chemical information. Initially, the spectra of small samples that are spiked with radioactive isotopes will be measured. Later attempts will be made to measure spectra in molten fuel in which realistic fissioning levels are generated either by external or internal neutron sources. Neutrons could be generated internally by interaction of the beryllium with high energy alpha particles, or perhaps by the addition of californium. Particular attention will be given to the effects on couples that will be involved in potentiometric measurements with reference electrodes.

6.6 TASK GROUP 5.3 ANALYSIS BY CHEMICAL METHODS

6.6.1 Objective

The objective of this task is to assure that the required chemical analysis methods are available to the Program when needed and to develop in-line chemical methods that will be essential to reactor operations. For the examination of discrete samples the definition of chemical methods as "methods in which the sample is altered by a chemical reagent" will be arbitrarily extended to include analytical procedures in which the samples may be subjected to analysis by diverse physical techniques such as X-ray diffraction and fluorescence, emission spectrography, and various spectro-physics approaches. Except for unusual circumstances, the actual performance of service analyses will not be an objective of this task group. Rather, the task group will provide liaison between users of analytical services and the service laboratories in order to promote the optimum selection of methods. Exceptions will include applications in which unique competences may exist within the Analytical Chemistry Research and Development Group and occasions in which onsite analysis can be performed more efficiently by group members. Task Group 5.3 will not include measurement performed on remelted samples. Such applications will be handled under the preceding tasks.

6.6.2 Schedule

The schedule for work in this task group is shown in Table 6.6.2.

6.6.3 Funding

Operating fund requirements for this task group are shown in Table 6.6.3.1, and capital equipment fund requirements are shown in Table 6.6.3.2.

6.6.4 Facilities

With the exception of limited expansion into conventional laboratories, no need for additional facilities is anticipated for Task Group 5.3 activities. Rather, the extensive facilities available at the Oak Ridge Complex will be utilized. Limited usage may also be made of facilities at the University of Tennessee with which the Laboratory maintains a close working relationship.

6.6.5 Task 5.3.1 Analysis of discrete samples

The need for analyses of discrete samples will continue throughout the Program and, indeed, will persist even for the most completely instrumented operating reactor. A wide variety of analytical techniques have already been applied to samples from the Program.⁸ The status of such

Table 6.6.2. Schedule for work in Task Group 5.3 - Analysis by chemical methods

	Fiscal year												
	1975	1976	1977	1978	1979	1980	1981	1982	1983	1984	1985	1986	
5.3.1 Analysis of discrete samples													
5.3.1.1 Bismuth	-----												
5.3.1.2 Oxide	-----												
5.3.1.3 Coolant cover gas condensate	-----												
5.3.1.4 Tellurium	-----	-----											
5.3.1.5 Precise uranium					-----	-----							
5.3.1.6 Special methods													
5.3.2 In-line chemical methods													
5.3.2.1 Salt flow metering	-----	-----											
5.3.2.2 Oxide in fuel	-----	-----	-----	-----									
5.3.2.3 Reducing power in fuel			-----	-----	-----								
5.3.2.4 Bismuth transpiration		-----	-----	-----									
5.3.2.5 Reducing power of bismuth alloys							-----	-----	-----	-----			
5.3.2.6 Oxide in coolant		-----	-----	-----	-----	-----							
5.3.3 Effects of radiation on chemical methods						-----	-----	-----	-----	-----			

Table 6.6.3.1. Operating fund requirements for Task Group 5.3 - Analysis by chemical methods
(costs in 1000 dollars)

	Fiscal year											
	1975	1976	1977	1978	1979	1980	1981	1982	1983	1984	1985	1986
5.3.1 Analysis of discrete samples												
5.3.1.1 Bismuth	1	5										
5.3.1.2 Oxide	4	2										
5.3.1.3 Coolant cover gas condensate	10	8										
5.3.1.4 Tellurium	1	3										
5.3.1.5 Precise uranium					12	17	25					
5.3.1.6 Special methods			7	9	11	14	15	15	15	20	20	
Subtotal 5.3.1	16	18	7	9	23	31	40	15	15	20	20	
5.3.2 In-line chemical methods												
5.3.2.1 Salt flow metering	6	6										
5.3.2.2 Oxide in fuel	2	10	18	20	22							
5.3.2.3 Reducing power in fuel			5	6	6	10						
5.3.2.4 Bismuth transpiration		5	12	10								
5.3.2.5 Reducing power of bismuth alloys							5	15	15	20		
5.3.2.6 Oxide in coolant		5	12	15	16	16	15					
Subtotal 5.3.2	8	26	47	51	44	26	20	15	15	20		
5.3.3 Effects of radiation on chemical methods						8	15	30	30	40	40	
Total operating funds for Task Group 5.3	24	44	54	60	67	65	75	60	60	80	60	

Table 6.6.3.2. Capital equipment fund requirements for Task Group 5.3 —
Analysis by chemical methods
(costs in 1000 dollars)

	Fiscal year					
	1975	1976	1977	1978	1979	1980
5.3 Miscellaneous items	2	13	1	30	9	

methods will be surveyed at intervals and a close liaison will be maintained with experimental investigators so that any required development work can be carried out in anticipation of needs. Also, a surveillance of new developments in the technology of analytical chemistry will be maintained to uncover approaches that could yield superior or more economical analyses of MSBR samples. Promising advances will be submitted to appropriate methodology groups for development or, when desirable, will be actively developed as a part of Subtask 5.3.1.6. Another responsibility inherent in this subtask will be to provide a disinterested third party on occasions when analytical results do not appear consistent with experimental operations. In many cases this activity will be limited to advisory actions, but may include performing the sampling and analysis operations or developing new methods. An essential part of this work will be to validate or improve methods for taking and preparing representative samples for analysis.

6.6.5.1 Subtask 5.3.1.1 Determination of bismuth

Because of the potential damage to structural materials by trace concentrations of bismuth transferred to the reactor via processing streams, extensive research and development studies will be carried out to develop methods of limiting such transfer. Methods of adequate sensitivity have already been developed to support such studies. An unacceptable scatter has been experienced in the analytical data obtained during efforts to measure the solubility of bismuth in fuel salts. Since the concentrations measured are below one ppm, the errors could readily have been introduced by the entrainment of particulate bismuth during sampling or by contamination introduced during sample preparation and dissolution. The entire sampling and analysis sequence will be examined, when such experiments are re-initiated, to locate possible sources of contamination and to determine whether some unexpected interference could have contributed to errors in the analysis. Remedial action will be recommended and appropriate procedures will be developed for the sampling and analysis of fuel salts for bismuth determination.

6.6.5.2 Subtask 5.3.1.2 Determination of oxide

Because trace concentrations of oxide can cause precipitation of fuel constituents, an accurate method for the determination of ppm concentrations of oxide will be used extensively in research studies to determine the tolerance of fuel for oxide and for determining the status of fuel in engineering test facilities. The $KBrF_4$ method will be used for the determination of oxide in discrete samples. Recently, the method was improved to permit measurements to the 10 ppm level, a sensitivity sufficient for the anticipated requirements of fuel analysis. Sample contamination by atmospheric constituents is a severe problem due to the small, typically 200 mg, pulverized samples that are used for the analysis. Work in this subtask will be directed to the elimination of contamination during the sampling sequence. Improvements in the quality of dry box

atmospheres are being made by the service groups and experiments have been designed to determine the magnitude, and source of contamination during sample preparation and transfer to the analytical apparatus. When these experiments have been completed and corrective action has been taken, similar experiments will be designed to study contamination during the withdrawal of samples from experimental facilities. An investigation of possible segregation of oxide during freezing will also be carried out, and criteria for the pulverization required for representative sampling will be established.

6.6.5.3 Subtask 5.3.1.3 Identification of condensate from the cover gas of NaBF₄

An oily condensate has been collected from the cover gas of engineering test facilities for the evaluation of NaBF₄-NaF eutectic as a coolant. Elemental analyses of this condensate are consistent with the presence of hydrolysis products of BF₃, but are not definitive. It has been shown that the condensable species is in equilibrium with active protons in the melt, and evidence exists that the material could serve as a vehicle for collecting tritium that diffuses into the coolant system.⁷² The identification of the individual compounds in this condensate is needed to assist in the understanding of the chemistry of protonated species in molten NaBF₄ and to design experiments to evaluate the potential of this coolant salt for tritium containment. Diverse chemical and physical methods such as NMR and infrared methods will be used to establish the composition of the condensate. Efforts will also be made to identify its precursor in the gas phase using either direct infrared measurements possibly with Fourier-transformed spectrometry or measurement of the spectra of matrix-isolated condensate. Once identified, the gases and condensed species will be compared with a synthetic material of similar properties that can be generated by the reaction of boron trifluoride with water. If these materials prove identical, the synthetic products will be used to establish analytical methods for the quantitative collection of condensate, its in-line measurement, and the conversion of its hydrogen content to the elemental form for isotopic analysis. Methods developed in these studies will be used at the CSTF in support of the Deuterium Injection Experiment to determine the potential of NaBF₄ for tritium containment.

6.6.5.4 Subtask 5.3.1.4 Determination of tellurium

Materials studies have indicated that tellurium is, at least in part, responsible for the intergranular cracking that was observed in Hastelloy N during operation of the MSRE. Concentrations of tellurium in the low ppm range will be present in fuel salts to which metallurgical specimens are exposed. Methods will be developed for the determination of tellurium at the required concentration levels. Atomic absorption, perhaps with pre-concentration, is the most likely approach for such determinations.

6.6.5.5 Subtask 5.3.1.4 Precise determination of uranium

Methods of high precision will be needed to detect variations in the concentration of uranium in the fuel that could be of significance to reactor operation (see Subtask 5.2.1.2). Such methods must be adaptable to remote determinations, because of the radioactivity of the samples, and be accurate to better than 0.1 percent. During the operation of the MSRE, it was shown that uranium could be quantitatively volatilized as UF_6 from 50 gram samples of the fuel, and the resulting UF_6 could be decontaminated and collected for isotopic analyses that are performed outside the hot cell. It was calculated that an isotopic dilution method could yield accuracies approaching 0.01 percent. The achievement of such accuracy would require equivalent precision in the addition and thorough mixing of a predetermined quantity of another uranium isotope to the fuel sample. Such an isotopic addition is feasible but will require extreme care in hot cell operation. Techniques will be designed to precisely weigh a fuel sample, make an isotopic addition, melt and homogenize the sample (possibly with hydrofluorination), and separate a representative sample of the isotopically diluted uranium for ratio measurements. Equipment to accomplish these operations will be assembled and tested in a hot-cell mockup.

6.6.5.6 Subtask 5.3.1.6 Development of special methods

This task will be devoted to the resolution of any special problems in the sampling and analyses that remain unresolved from previous studies or that will arise in the course of research and development studies for the Program. One known problem of this type is the separation of sufficient quantities of particulate matter, iron and nickel, from fuel for characterization. The identification of the nature of such material could assist in thermodynamic predictions of equilibrium conditions and resolve anomalies that have been observed earlier in the Program.

6.6.6 Task 5.3.2 In-line chemical methods

Because of the nature of the application, in-line analysis of salt streams by chemical methods will usually be limited to transpiration techniques; that is, the introduction of a reagent as a dilute solution in an inert gas stream followed by measurements on the effluent gas or, in some cases, in the effluent salt by transducers described in the previous task groups. Other methods of reagent addition, such as in a stream of salt or a bismuth alloy, will be considered, but such approaches appear cumbersome for high-temperature application. Transpiration methods will be closely related to developments in Task Group 5.4, Analysis of Gas Streams.

6.6.6.1 Subtask 5.3.2.1 Metering of salt flows

The chemical methods will, in general, measure an extensive property of the molten salt as opposed to intrinsic measurements performed by electrochemical or spectrophotometric methods (Task Groups 5.1 and 5.2); therefore, a measurement of the quantity of salt subjected to analysis is required. This could be accomplished by analyzing discrete samples that are temporarily isolated from the streams, but this would not permit continuous measurement which may be required in some applications. Methods will be developed for the metering of small flows of molten salt, and it is estimated that flow rates of 2 to 3 ml per minute will be optimum for many of the analyses. Flow metering might be accomplished by passive flow elements such as capillaries or orifices, but in view of the uncertainties in wetting properties of the salts, a positive pumping action would appear more reliable. Aqueous mockups of various conceptual designs of salt pumps will be tested. These will include simple mechanical devices, such as bucket lifts, an archimedian pump, and a pump utilizing liquid bismuth valves. Final testing of workable devices will be done in the Analytical Test Facility.

6.6.6.2 Subtask 5.3.2.2 Determination of oxide in fuel

A continuous surveillance of ppm concentrations of oxides in the fuel salt of a reactor may be required. While it is anticipated that more convenient methods will be devised for determination of the concentration of soluble oxide ion (Subtask 5.1.1.10), a chemical method would be needed to determine total oxide in the event that tolerance levels are exceeded. Work will be initiated for adapting the hydrofluorination method for oxide analysis¹¹ to continuous in-line measurements; the extent to which the necessary development work will be carried out will depend on the success of developing alternate oxide analysis techniques, and determination of the necessity for continuous oxide analysis. Aqueous mockups of a system to deliver metered salt flows to a countercurrent hydrofluorination column will be tested. The results of these tests will be used to provide design criteria for the Analytical Test Facility. Experimental investigations in this facility will be used to develop a practical in-line system, which will then be used to monitor oxide in the GSTF or other appropriate facilities. Consideration will also be given to the measurement of oxygen or oxygen fluorides in the gas from the fluorinators of the processing system in order to provide an alternate measurement of oxide.

6.6.6.3 Subtask 5.3.2.3 Determination of reducing power in fuel

Reducing power or reducing normality, the measurement of the hydrogen liberated on dissolution of fuel samples in HCl, was the original method used to determine the oxidation state of discrete samples. An equivalent in-line determination together with a U^{3+} determination would provide information on the total quantity of particulate metals in the fuel and contribute information on the redox potential in an experimental reactor.

The apparatus for the determination of oxide could readily be converted to incorporate a reducing power determination. The substitution of precious metal components and the use of HF-helium mixtures in place of HF-hydrogen would lead to the oxidation of the particulate metals. A measurement of hydrogen in the effluent gas would then complete the determination. Such a procedure would also provide an effluent stream of oxidized fuel that can be used to measure total quantities of individual corrosion products by electroanalytical methods (see Subtask 5.1.1.7, Determination of total corrosion products). Rate data for the estimation of needed countercurrent hydrofluorination conditions will be established by measurements of the hydrofluorination of isolated samples of fuel from the GSTF. The extent to which work in this subtask will be pursued will depend upon a continuing analysis of the necessity of determining fuel reducing power.

6.6.6.4 Subtask 5.3.2.4 Study of transpiration of bismuth

The in-line measurement of bismuth in the return stream from the processing system will require quantitative oxidation of entrained bismuth and bismuthide to the trivalent state. A study will be made to determine whether finely divided bismuth can be oxidized by a countercurrent hydrofluorination technique. It has been noted that bismuth trifluoride slowly disappears from research fuel melts in contrast to other ions which are quite stable. This phenomenon may reflect the volatility of bismuth trifluoride under these conditions, and, in fact, a recent report shows that solid BiF_3 has an appreciable vapor pressure at reactor temperatures.⁶⁶ Studies (Subtask 5.1.1.3) now in progress will determine whether the loss of bismuth is through volatilization. If so, the distribution coefficient between fuel and cover gas will be determined, and the possibility of using a transpiration method for isolating BiF_3 for measurement will be investigated. Final determination of the bismuth could be made with high sensitivity by atomic absorption, or perhaps by advanced infra-red techniques. Thus, a single apparatus could provide gas streams for the measurement of oxide, total reducing power, and bismuth trifluoride, and a salt stream for the measurement of total concentrations of corrosion products and possibly bismuth.

6.6.6.5 Subtask 5.3.2.5 Determination of reducing power in bismuth alloys

At present, both the reference and alternate flowsheets for fuel processing include reductive extraction with lithium-bismuth alloys for separation of the rare earth elements. A measurement of the total reducing power of bismuth streams based on hydrofluorination could provide data required to maintain alloy concentrations at optimum levels. In conjunction with other analytical techniques, this method could also be used to measure the concentration of the individual metals in the alloys and thus detect undesirable accumulation of a particular metal such as iron. Measurement of the hydrogen generated by the hydrofluorination of

a small side stream of bismuth alloy under conditions at which negligible oxidation of the bismuth is incurred would provide a sensitive measure of the total equivalents of oxidizable alloying constituents. Performing the hydrofluorination in contact with a metered stream of purified LiF-BeF₂ would provide a salt stream containing proportional concentrations of the alloying constituents including thorium, for measurement by electroanalytical or spectrophotometric methods.

Basic studies will be performed to determine the conditions under which pure bismuth, in contact with LiF-BeF₂, can be contacted with HF in an inert gas without generating unacceptable quantities of hydrogen. If such conditions cannot be established, trace additions of hydrogen will be incorporated into the sparge gas to determine whether the oxidation of bismuth can be suppressed without compromising the measurement of hydrogen generated by the oxidation of alloying constituents. Oxidative hydrofluorination of representative metals from bismuth alloys will then be studied using the best compromise gas mixture as a transpiration reagent. Much of this basic information will result from other research and development activities of the Program.

The basic data will be used to design experiments to demonstrate the feasibility of the approach and to establish its capabilities and limitations for in-line measurement. This will probably require the construction of a modest facility utilizing gravity-fed streams. The extent to which work in this subtask will be pursued will depend on the success in developing simpler alternate analysis techniques.

6.6.6.6 Subtask 5.3.2.6 Determination of oxide in coolant salts

The role of oxide in the present NaBF₄-NaF coolant salt is not yet fully understood. The oxide tolerance is apparently quite high; concentrations in excess of 2000 ppm have been measured in filtered samples from research melts to which oxide has been deliberately added. Also, it has been suggested⁶⁴ that substantial concentrations of oxide can exert a benign effect by contributing to the sequestering of tritium that diffuses from the primary system. It is, therefore, not certain that an in-line method for oxide in fluoroborates will be essential to reactor operations. However, an in-line method might be more economical in the long run because induced activity in the samples will probably be sufficient to require expensive hot-cell analyses of discrete samples. Also, much of the basic studies needed for an in-line method would be applicable to analysis of individual samples.

A hydrofluorination method will be the first choice for testing. The initial investigation will have to be indirect because BF₃ in the effluent gas will interfere with established methods for measurement of the "water" generated by the hydrofluorination of oxide. Accordingly, melts containing readily measurable concentrations of oxide will be subjected to hydrofluorination by HF in a stream of helium that contains an equilibrium concentration of BF₃. Estimation of reaction rates will be made by

measuring the decrease in oxide concentration by the KBrF_4 method. (N.B. It is not, at present, considered practical to adapt the versatile KBrF_4 method to the analysis of highly radioactive MSBR samples. To avoid contamination during transfer, it would be necessary to perform the measurement within an inert atmosphere hot-cell. This concept was examined during the development of the analytical chemistry program for the MSRE and found to be exorbitantly expensive and subject to potential safety hazards). If the rate of hydrofluorination of oxides proves too low for analytical applications, stronger oxidants, such as fluorocarbons, will be tested in a similar manner. When an effective reactant is discovered, methods will be developed for the measurement of oxygen-bearing products in the transpiration effluent under Task Group 5.4. In the case of fluorocarbon oxidation, infrared techniques will be tested for the determination of expected constituents such as CO and COF_2 . For hydrofluorination effluents, methods developed under Subtask 5.4.3.3 will probably be applicable because the oxygen is expected to be incorporated in the protonated species. Data from these studies will be used to design a countercurrent transpiration system that will be functionally similar to that used for the measurement of oxide in fuel. This system will be tested in the Analytical Test Facility after fuel tests are completed or by using salt streams from the CSTF.

6.6.7. Task 5.3.3 Effects of radiation on chemical methods

It is not anticipated that significant problems will be encountered in the use of chemical methods for the analysis of discrete samples. The intensity of radiation experienced in such measurements will in general be reduced to more tolerable levels by the use of small or diluted samples and by the decay that will occur during transfer to hot cells. In the analysis of MSRE samples no degradation of precision and accuracy was observed that could not be attributed to problems of remote handling. New technology in remote analysis will be incorporated as it is available into the already developed methods for these radioactive samples. Any additional developments will be based on established principles to limit radiation effects and the new methods will be verified by standard addition techniques.

For in-line chemical methods, which will usually be based on transpiration techniques, the gaseous reactants and products will be subjected to at least transitory exposure to intense radiation. It is planned whenever possible to conduct the reactants to analytical transducers that will be located outside the area of highest radiation intensity. This may not be possible in the case of products whose absorption in gas lines would impose prohibitive time lags on the measurement. Even momentary exposure to the radiation fields could cause sufficient radiolysis of the reactants and products to compromise the analytical measurements; also, the transpiration streams could carry fission product gases and particulate radioactive matter to the analytical transducers. In cases where established G values are available, the effects of radiolysis will be estimated. If radiolysis effects are unacceptable, corrective measures will be taken.

Analytical transducers will be modified to eliminate materials that are known to be sensitive to radiation. Models of the analytical devices will be tested under simulated exposures that will include the transpiration of spiked salt samples and the addition of fission product gases to the transpiration streams. More realistic testing will be carried out under in-pile conditions if other activities of the program present an opportunity.

6.7 TASK GROUP 5.4 ANALYSIS OF GAS STREAMS

6.7.1 Objective

The objective of this task is to assure that gas analysis methods will be available when needed for reactor applications and for the research and development studies of the program. Needed determinations will include atmospheric contaminants, H₂, HF, F₂, UF₆, fission product gases, BF₃ and its hydrolysis products, and tritium. As in the previous task group (Analysis by Chemical Methods) this activity will not be of a predominantly innovative nature. Many commercial instruments are available that can be used directly or with modifications for these determinations. It is anticipated that improved instrumentation will become available as a result of pollution control developments. To achieve this objective it will be necessary to maintain a surveillance of developments in the gas analysis field so that appropriate instrumentation can be recommended. Whenever possible, equipment that can ultimately be adapted to MSBR applications will be recommended for research and development activities of the Program. This will provide practical experience and limit evaluation of alternate equipment.

6.7.2 Schedule

The schedule for work in this task is shown in Table 6.7.2.

6.7.3 Funding

Operating fund requirements for this task group are shown in Table 6.7.3.1, and capital equipment requirements are shown in Table 6.7.3.2.

6.7.4 Facilities

No unusual facilities will be required for this activity since the various Program facilities will generate gas streams for realistic testing.

Table 6.7.2. Schedule for work in Task Group 5.4 -- Analysis of gas streams

	Fiscal year												
	1975	1976	1977	1978	1979	1980	1981	1982	1983	1984	1985	1986	
5.4.1 Analysis of fuel cover gas													
5.4.1.1 Gas chromatographic methods	-----				-----								
5.4.1.2 In-line mass spectrometric methods		-----			-----								
5.4.1.3 Specific constituent monitors		-----			-----								
5.4.2 Analysis of process gas streams													
5.4.2.1 UF ₆						-----	-----	-----	-----	-----			
5.4.2.2 HF						-----	-----	-----	-----	-----			
5.4.2.3 F ₂							-----	-----	-----	-----			
5.4.2.4 H ₂ -HF mixtures							-----	-----	-----	-----			
5.4.3 Analysis of coolant cover gas													
5.4.3.1 Isotopes of hydrogen	-----	-----											
5.4.3.2 Hydrogenous compounds	-----	-----											
5.4.3.3 Distribution of hydrogen isotopes	-----	-----											
5.4.3.4 In-line spectrometric methods			-----	-----	-----								
5.4.4 Effects of radiation on gas analysis equipment							-----	-----	-----	-----	-----	-----	-----

Table 6.7.3.1. Operating fund requirements for Task Group 5.4 - Analysis of gas streams
(costs in 1000 dollars)

	Fiscal year											
	1975	1976	1977	1978	1979	1980	1981	1982	1983	1984	1985	1986
5.4.1 Analysis of fuel cover gas												
5.4.1.1 Gas chromatographic methods		5	10	15	9							
5.4.1.2 In-line mass spectrometric		5	10	12	15	17						
5.4.1.3 Specific constituent monitors		5	7	9	12	14	15	15	10	10		
Subtotal 5.4.1		15	27	36	36	31	15	15	10	10		
5.4.2 Analysis of process gas streams												
5.4.2.1 UF ₆						10	10	15	10	5		
5.4.2.2 HF						10	10	5	5	5		
5.4.2.3 F ₂							5	5	5			
5.4.2.4 H ₂ -HF mixtures							5	5				
Subtotal 5.4.2						20	30	30	20	10		
5.4.3 Analysis of coolant cover gas												
5.4.3.1 Isotopes of hydrogen	6	8	4									
5.4.3.2 Hydrogenous compounds	6	6										
5.4.3.3 Distribution of hydrogen isotopes	4	6	8									
5.4.3.4 In-line mass spectrometric methods			5	9	12							
Subtotal 5.4.3	16	20	17	9	12							
5.4.4 Effects of radiation on gas analysis equipment						9	20	25	30	40	40	
Total operating funds for Task Group 5.4	16	35	44	45	48	60	65	70	60	60	40	

Table 6.7.3.2. Capital equipment fund requirements for Task Group 5.4 —
 Analysis of gas streams
 (costs in 1000 dollars)

	Fiscal year							
	1975	1976	1977	1978	1979	1980	1981	1982
5.4 Miscellaneous items			2		5	7	5	
5.4 Prototype gas chromatograph			25					
5.4 Quadrapole mass spectrometer		25						
5.4 On-line computer						30		
Total capital equipment funds for Task Group 5.4		25	27		5	37	5	

6.7.5 Task 5.4.1 Analysis of fuel cover gas

Purified inert gas will be used to protect both the coolant and fuel from exposure to atmospheric constituents and to remove fission product gases from the fuel in an MSR. Both the purification and analysis of helium were successfully performed at the MSRE and no significant analytical development is anticipated for these operations. The determination of residual atmospheric gases, gases desorbed from the graphite moderator, tritium, and possibly the isotopic composition of fission gases in the off-gas from the fuel system will be required. Suitable commercial analyzers exist for these determinations but may not be universally applicable because of the radioactivity in the gas stream. Limited in-line methods were applied to fuel off-gas during the MSRE development and operation. A gas chromatograph that utilized a helium break-down detector sensitive to sub-ppm concentrations of inorganic gases was successfully applied to the analysis of off-gas from in-pile fuel capsules.⁴⁸ No evidence of radiation interference was encountered but the instrument is not expected to be reliable for long term usage. Simple devices involving thermal conductivity cells were used to determine the general purity and hydrocarbon content of cover gas from the MSRE. Methods for cryogenically collecting fission product gases for isotopic measurement were developed. Tritium was also collected for counting outside the reactor area. The devices used for these measurements are not considered adequate in both sensitivity and long-term radiation stability for reactor applications and improved devices will be developed during the course of the Program to meet reactor requirements.

6.7.5.1 Subtask 5.4.1.1 Development of gas chromatographic methods

Gas chromatography is one of the more versatile tools for in-line gas analysis. However, the more sensitive detectors generally utilize ionization phenomena and will thus be subject to severe interferences at the anticipated levels of radiation. One solution is to concentrate the impurities by cryogenic trapping and utilize thermal conductivity cell detectors. This solution, however, would decrease the frequency of analyses and require the use of liquid nitrogen in intense radiation fields. Therefore, a search for more sensitive detectors which are not affected by radiation will continue. Efforts will be made to discover the reason for the sporadic unstable response of the helium break-down detector, and modifications of an ultrasonic detector will be made to eliminate materials that are subject to radiation damage. This latter device could also serve as an improved katharometer in instruments for the measurement of specific constituents or groups of constituents in Subtask 5.4.1.3. Gas chromatographic sampling valves are also generally subject to radiation damage because they contain elastomers which would degrade under the anticipated radiation exposure and generate radiolysis products that could interfere with the determinations. An all-metal, pneumatically actuated sampling valve was developed earlier. The valve is, however, rather complex and expensive and can easily malfunction if

contaminated by particulate matter. A novel concept that utilizes fluidic control principles will be investigated. A chromatograph that utilizes radiation-resistant components and inorganic absorption columns will be developed and tested on the cover gas of the GSTF. Application to radiation environments will be demonstrated subsequently in Task 5.4.4.

6.7.5.2 Subtask 5.4.1.2 Development of in-line mass spectrometric methods

Quadrupole mass spectrometers can be installed near sources of gas samples and could supplement and perhaps replace gas chromatographs in many analytical applications. They will be particularly valuable for the measurement of deuterium-to-hydrogen ratios when deuterium is used to study the containment of tritium. An instrument that most closely meets the anticipated requirements for the program will be selected and interfaced to gas streams of the GSTF. An additional analyzer head will be purchased for applications to the CSTF.

6.7.5.3 Subtask 5.4.1.3 Development of specific constituent monitors

Many analytical gas devices have been developed for the measurement of individual constituents or classes of compounds that may be present in fuel cover gas streams. Such devices, which include nondispersive infrared equipment, various forms of moisture monitors, and newly developed solid state detectors, will be tested for providing measurements of improved sensitivity or as back-up methods for the most important determinations. A particular class of specific ion monitor is based on the thermal conductivity cell. The measurement is related to the change in the thermal conductivity of gas streams that results from the subtraction or alteration of a constituent or class of materials by trapping or by chemical reaction. It is not expected that thermal conductivity cells will provide sufficient sensitivity for most of the required measurements of the program. If, however, an ultrasonic detector can be adapted to this type of measurement, a class of devices that would provide continuous measurement of most of the constituents of interest could be developed. Systems based on this detector will be developed with regenerable traps and chemical reactants for long term usage.

6.7.6 Task 5.4.2 Analysis of gas streams from the processing system

In-line analyses of gas streams of the processing system will provide a means of controlling certain processes and for indicating the operational status of parts of the system. In general, the required determinations can be performed by established methods in devices which can be located outside areas of intense radioactivity. The methods that are tentatively proposed for such application are outlined below.

6.7.6.1 Subtask 5.4.2.1 Determination of UF₆

Measurements of UF₆ would be made in the effluent gas from the fuel reconstitution system. Uranium that escapes hydrogenation could be temporarily excluded from the reactor systems and thus effectively reduce the breeding ratio. The intense absorption of UF₆ in the ultraviolet has been used to measure concentrations at the ppm level. Practical investigation including the selection of compatible window materials will be performed to develop in-line instrumentation for this and similar streams. Such methods will be tested in the Integrated Process Test Facility or in support of earlier development activities.

6.7.6.2 Subtask 5.4.2.2 Determination of HF

HF in varying concentrations will be present in processing streams and perhaps in the cover gas of the fuel system. During operation of the MSRE, a method was developed for the determination of traces of HF in the fuel off-gases.⁷³ This method was based on the depolarization of an aluminum anode and utilized an aqueous absorber which would probably be undesirable for use with reactor processing streams. Infrared absorption methods will probably be satisfactory for the measurement of HF in the overhead of the distillation section of the HF recycle system. Infrared methods could also be applied to the determination of HBr and HI in this stream. Practical in-line absorption cells will be designed and tested for this application. A method developed to measure micromolar quantities of HF that are generated during the transpiration of fuel with hydrogen¹³ will be used if more sensitive measurements are needed.

6.7.6.3 Subtask 5.4.2.3 Determination of F₂

In-line determinations of fluorine will be useful in controlling the operation of the fluorinator section. The sample input to the analytical system will be a binary mixture of fluorine and an inert gas. The fluorine can then be readily determined with a thermal conductivity cell or a gas density balance. The precisions and lifetimes of such devices in this application will be evaluated. For excess fluorine in the effluent, ultraviolet absorption methods will be used, with preconversion to chlorine if additional sensitivity is needed. A practical in-line cell will be developed for this measurement and the interference of other components of this stream will be evaluated.

6.7.6.4 Subtask 5.4.2.4 Analysis of H₂-HF mixtures

The in-line measurement of the composition of the effluent gas from the fuel reconstitution system will assist in the achievement of more efficient reduction of UF₆. The concentrations of H₂ and HF can readily be measured with thermal conductivity cells. Components that provide long lifetimes in this application will be selected.

6.7.7 Task 5.4.3 Analysis of coolant cover gas

As with previous tasks related to coolant studies, priority will be granted to the development of methods for the coolant system in order to provide analytical support for the Deuterium Injection Experiment. It is expected that in-line gas analytical devices in reactor applications will not be subjected to significant radiation exposure and, therefore, more conventional insulating materials such as Teflon can be used. The work in this task will be associated initially with the measurement of hydrogen and deuterium and later with tritium. If a fluoride salt is chosen as an alternate coolant the methods developed for the fuel cover gas (Task 5.4.1) are expected to be equally applicable to the cover gas streams of the coolant system.

6.7.7.1 Subtask 5.4.3.1 Determination of elemental hydrogen isotopes

In order to interpret the results of experiments on the diffusion of deuterium into the coolant salt it will be necessary to measure H_2/D_2 ratios and ultimately to measure the ratios of free to combined hydrogen and deuterium in the cover gas streams. A method based on the diffusion of hydrogen through a heated palladium membrane into an evacuated system appears to be the most promising approach for the measurement of hydrogen isotopes that are present in the cover gas. When equilibrium is attained, the partial pressures of the elemental hydrogen will be equal on both sides of the membrane. The measurement of pressure developed within the evacuated system thus provides a sensitive determination of the concentration of hydrogen within the gas stream. The hydrogen will also be in a suitable form for the measurement of isotopic ratios. A system has been fabricated which has a resistance-heated tube of silver-palladium alloy as a diffusion membrane. Recently, commercial equipment to accomplish similar separations has become available. The separation system or its commercial equivalent will be tested with simulated cover gas streams to which standard additions of deuterium and hydrogen have been added. The most successful device will be used to provide measurement in the off-gas of the CSTF. Initially, isotopic measurements will be made on samples collected for mass spectrometric methods. When a mass spectrometer becomes available it will be coupled with the diffusion system to provide real time data. A swept diffusion system will also be developed to effect in-line measurement of tritium by internal gas proportional counting.

6.7.7.2 Subtask 5.4.3.2 Identification of hydrogen compounds

This activity is closely associated with Subtask 5.3.1.3, Identification of condensate from the cover gas of $NaBF_4$. It has been definitely established that at least one condensible species is in equilibrium with active protons in fluoroborate melts. Evidence has also been obtained that tritium is present in much greater concentration in the condensate than in the salt from which it was derived. The identification of the hydrogen

compounds in the cover gas, which are tentatively postulated to consist of hydrates of boron trifluoride, will be of considerable value in establishing the chemistry of protonated species in the fluoroborate melts and in identifying a possible mechanism for the collection of tritium. Since rather complex equilibria are expected to be established in the liquid condensate, direct measurements in the vapor phase must be used for unambiguous identification. Attempts will be made to measure infrared absorptions of the volatile species at their low concentrations in the CSTF cover gas and in simulated cover gas streams that are produced by mixing boron trifluoride and water in varying proportions and under diverse conditions. Mass spectrometric methods will be used to examine these simulated cover gases. Matrix-isolation condensation will also be used to collect samples of the protonated species for infrared examination.

6.7.7.3 Subtask 5.4.3.3 Determination of hydrogen compounds and distribution of isotopes

With data on elemental hydrogen concentrations from subtask 5.4.3.1, the measurement of the combined hydrogen and deuterium in the CSTF cover gas will permit the calculation of ratios of free to combined hydrogen and deuterium. These ratios will be needed to evaluate the effectiveness of fluoroborate coolant for tritium containment. The measurement of the increase in concentration of elemental hydrogen that results from the in-line reduction of cover gas streams will reflect the concentration of combined hydrogen. Various in-line reductants including NaK and heated magnesium will be tested for quantitative liberation of elemental hydrogen. The hydrogen in the reduced streams will be determined by means of the palladium membrane technique which will also permit the measurement of hydrogen-to-deuterium ratios in the hydrogen that is liberated from these compounds. The possibility of distinguishing between different hydrogen compounds by a sequence of reactions with selectively stronger reductants will also be studied.

6.7.7.4 Subtask 5.4.3.4 Development of in-line mass spectrometric methods

A heated interface fabricated from materials such as nickel that are expected to be compatible with the constituents of the CSTF cover gas will be used to introduce samples of the gas to the resolving head of a quadrupole mass spectrometer. This system will be used to test the feasibility of the measurement by mass spectrometry of the various constituents that were measured by specific constituent monitors developed in the above subtasks. An additional sample inlet will be provided to permit the measurement of isotopic ratios in the hydrogen that is separated by the palladium membrane analyzers.

6.7.8 Task 5.4.4 Effects of radiation on gas analysis equipment

Whenever possible the gas analytical equipment will be located outside areas of intense radiation to minimize radiation effects. In the case of trace element measurements this may not be possible because of the excessive time constants of the sample transfer lines. Experimental measurements of time constants for the transfer of simulated gas streams of all expected types will be made to determine which analyzers must be located close to the sample source. All possible means, such as heated transfer lines of selected low absorbing materials, will be used to minimize the time constants. As noted in Subtask 5.4.3.1, the analytical equipment, even in optimum locations, can receive significant radiation exposure from fission product gases and particulate radioactive material. This exposure will be most significant in the analysis of gases from the fuel and from the fluoride streams of the fuel processing system. The use of filters to exclude particulate matter and thus simplify maintenance will be evaluated. Models of analytical equipment that have been modified to minimize radiation effects will be tested under exposure at appropriate radiation levels. Industrial radiography sources will be used to simulate external exposure and synthetic samples generated by the addition of fission product gases will be used to study the effects of internal exposure.

6.8 TASK GROUP 5.5 MEASUREMENT OF FISSION PRODUCTS AND PROTACTINIUM BY GAMMA SPECTROMETRY

6.8.1 Objective

The objective of this activity is to develop methods for the direct measurement of the distribution of fission products and protactinium by gamma spectrometry. The deposition of certain fission products in reactor components is of major interest to reactor safety and operations. The in-line measurement of certain fission products and protactinium in salt streams would contribute to the evaluation of the operation of the processing system. A wealth of information was obtained by gamma scans during the latter periods of MSRE operation. This task group will be devoted to the fullest possible exploitation of this technique.

6.8.2 Schedule

The schedule for work in this task group is shown in Table 6.8.2.

6.8.3 Funding

The operating fund requirements for this task group are shown in Table 6.8.3. Capital equipment funds will be required in the amounts of \$50,000 and \$30,000 during FY 1981 and FY 1984, respectively, for purchase of equipment for development of gamma spectrometry techniques.

Table 6.8.2. Schedule for work in Task Group 5.5 — Detection of fission products and protactinium by gamma spectrometry

	Fiscal year							
	1979	1980	1981	1982	1983	1984	1985	1986
5.5.1 Evaluation of method								
5.1.1.1 Analysis of MSRE data		—						
5.1.1.2 Evaluation of advanced equipment		—						
5.5.2 In-pile activation experiments			—	—	—	—		
5.5.3 Equipment for reactor applications						—	—	

Table 6.8.3. Operating fund requirements for Task Group 5.5 — Detection of fission products and protactinium by gamma spectrometry
(costs in 1000 dollars)

	Fiscal year							
	1979	1980	1981	1982	1983	1984	1985	1986
5.5.1 Evaluation of method								
5.1.1.1 Analysis of MSRE data		10	3					
5.1.1.2 Evaluation of advanced equipment		5	10					
Subtotal 5.5.1		15	13					
5.5.2 In-pile activation experiments			17	45	45	40		
5.5.3 Equipment for reactor applications						10	30	
Total operating funds for Task Group 5.5		15	30	45	45	50	30	

6.8.4 Facilities

No additional facilities will be required for this activity. Existing research reactors and computer centers of the Oak Ridge complex will be used.

6.8.5 Task 5.5.1 Evaluation of method

A variety of fission products were located and identified on surfaces of MSRE components by using a system comprised of a lithium-drifted germanium detector, a 4096 channel analyser, and a lead collimator to permit examination of small areas. Much valuable quantitative and qualitative information was obtained on the deposition of fission products on major components and on the distribution of fission product gases in the system; but some problems in the interpretation of data were encountered, particularly for scans made during full power operation.⁷⁴ These problems were generated by the multitude of overlapping photopeaks of short-lived isotopes for which adequate energy characterizations were unavailable and the inability of the computer program to resolve the large number of higher order (greater than triplet) multiplets that were found in the spectra. Since significant concentrations of ^{233}Pa were not present in the MSRE, the experimental data does not permit evaluation of the potential of this technique for its measurement. The technique, in its present state of development could probably be used to measure the simpler combinations of isotopes that will be present in some of the processing streams. With improvements in resolution it could supply continuous data that would contribute to the safe and efficient operation of an MSBR.

6.8.5.1 Subtask 5.5.1.1 Evaluation of MSRE data

The data obtained by gamma scans of MSRE components will be reevaluated by using an updated library of isotopic spectra and any improved computer programs for the resolution of gamma spectra that may become available. From predictions of delays in transport and from chemical resolution data that will be generated by other research and development activities of the Program, the abundance of radioactive isotopes will be computed for significant locations within the primary and processing systems of an MSBR. These computations will, in turn, be used to generate synthetic spectra emitted from these selected areas and predict benefits that could be expected from instrumentation of improved resolution.

6.8.5.2 Subtask 5.5.1.2 Evaluation of advanced equipment

Data derived from the preceding subtask will be used to assess the value to reactor monitoring of any technological advances in high-resolution gamma spectrometry. The most suitable combination of detectors and analysers will be selected and acquired for experimental applications.

6.8.6 Task 5.5.2 In-pile activation experiments

In-pile activation experiments will provide a variety of information that is relevant to general applications of gamma spectrometry, but will be designed primarily to assess the potential of the technique for the monitoring of protactinium - a determination that may tax the capabilities of other in-line methods. The experiments will, in general, involve the measurement of spectra of simulated fuel samples after neutron irradiation, but may also be extended to include the characterization of emissions of critically interfering short-lived isotopes that can be generated by various available methods of activation. Fuel irradiation experiments will progress from the recording of gamma scans from small fuel samples subjected to brief irradiation in an analytical activation facility (to measure photopeaks and decay rates of short-lived primary fission products) to long-term irradiation of capsules of molten or solid fuel at realistic fluxes in a research reactor (to generate measurable levels of ^{233}Pa). If the detector system can be sealed for underwater operations, measurements immediately after withdrawal can be made conveniently at the ORR. Sufficient measurements will be taken to determine the decay period required to permit the measurement of protactinium over the range of required concentrations. Supplemental data on the relative affinity of individual fission products can be gained by performing the experiments with capsules fabricated from composite materials or with capsules containing metallurgical specimens.

6.8.7 Task 5.5.3 Selection and design of equipment for reactors

Components of experimental and power reactors that will require continuous or intermittent gamma surveillance will be identified through consultation with other disciplines of the Program. From computations and experimental data, specifications will be prepared for transducers for measurements at each of the required locations. Since requirements of spatial and photopeak resolution will vary widely, performance specifications for each measurement will be determined individually and will generally involve a compromise of resolution capabilities and practical considerations such as reliability, coolant requirements, and adaptability to remote maintenance. Appraisal of new developments (Subtask 5.3.1.2) will be continued to assure optimum selection of equipment. Each device will require a complex and expensive installation; therefore, the use of a single transducer device for intermittent monitoring of different components will be utilized when practical. Gimbal systems for the precise aiming of the massive collimating and shielding assemblies will be developed or submitted to vendors.

If it proves impractical to measure protactinium at essential locations with the decays inherent in transport of fuel through the processing system, the concept of delay lines will be explored. A delay line would consist of a parallel stream of salt in which the flow is restricted to delay the arrival of fluid to the point of measurement by a period sufficient to permit decay of interfering isotopes.

6.9 TASK GROUP 5.6 IN-LINE ANALYTICAL TEST FACILITY

6.9.1 Objective

The objective of this activity is to perform the necessary conceptual design and development studies for the Analytical Test Facility, to provide the guidance and direction that will be needed to design and fabricate the facility which will deliver representative molten-salt streams of controlled composition to experimental analytical devices, and to utilize the facility to perfect these analytical devices. As this will be a unique facility of the Program, efforts will be made to incorporate capabilities that will permit other applications such as basic chemical studies for measuring reaction rates in MSBR melts.

6.9.2 Schedule

The schedule for work in this task group is shown in Table 6.9.2.

6.9.3 Funding

Operating fund requirements for this task group are shown in Table 6.9.3. Capital equipment funds in the amount of \$100,000 will be required during FY 1976 for design and construction of the Analytical Test Facility.

6.9.4 Task 5.6.1 Conceptual design and definition of experimental program

This activity will be directed to the complete delineation of the capabilities that will be needed to evaluate the performance of various in-line analytical transducers in terms of reliability, reproducibility, time constants, and effect of variables such as temperature, flowrate, etc. Presently, it appears that these requirements will be best fulfilled by a small pumped system that will deliver gravity-fed and/or pressurized salt streams to transducers for electroanalytical, spectrophotometric, chemical, and special methods developed in Task Group 5.7, and conform to additional requirements as follows. The salt capacity, typically ≤ 20 Kg of fuel, will be adequate to provide chemical inertia against gross changes from the introduction of trace contaminants but small enough to permit ease in making adjustments in composition. Materials that contact the salt will be limited to noble metals such as copper and nickel to permit stable operation with relatively oxidizing melts. Most of the above and many other features were incorporated in an earlier design⁷⁵ that utilized a gas lift instead of the proposed mechanical pump.

The considerations leading to the initial design will be reviewed to determine what additional capabilities will be feasible with increased pumping capacity and what may be needed for the more complete evaluation of in-line analytical devices. Consultations will be held with other potential users of the facility to determine other needed capabilities

Table 6.9.2. Schedule for work in Task Group 5.6 - In-line Analytical Test Facility

	Fiscal year									
	1975	1976	1977	1978	1979	1980	1981	1982	1983	1984
5.6.1 Conceptual design and definition of experimental program	—									
5.6.2 Development work for final design	—	—								
5.6.3 Final design		—	—							
5.6.4 Fabrication, installation, and initial testing		—	—	—						
5.6.5 Operation				—	—	—	—	—	—	—

Table 6.9.3. Operating fund requirements for Task Group 5.6 - In-line Analytical Test Facility
(costs in 1000 dollars)

	Fiscal year									
	1975	1976	1977	1978	1979	1980	1981	1982	1983	1984
5.6.1 Conceptual design and definition of experimental program	4									
5.6.2 Development work for final design	8	10								
5.6.3 Final design		15								
5.6.4 Fabrication, installation, and initial testing		5	40							
5.6.5 Operation				50	60	65	70	70	40	
Total operating funds for Task Group 5.6	12	30	40	50	60	65	70	70	40	

that can be incorporated, and with materials, mechanical, and safety specialists to evaluate the practicality and cost of various features of the facility. Data gained in these activities will be used to develop the conceptual design for a versatile system that will incorporate performance, dimensional, and materials specifications.

6.9.5 Task 5.6.2 Development work required for final design

The testing of transpiration equipment is expected to impose the most critical requirement for salt streams delivered by the Analytical Test Facility. Most of these requirements (adequate pressure and space for metering systems and countercurrent contactors) will be established by mock up studies performed in Task Group 5.3. Any additional definition of these requirements and those for the installation of other types of transducers will be made by additional mock-up studies. Questions relative to the circulating system itself such as mixing times and effects of dead volumes, will be resolved by experiments in glass or plastic models of sections of the system. Data acquired will form the basis for specifications for the final design of the facility.

6.9.6 Task 5.6.3 Final design

Assistance will be provided as necessary to design engineers in order to expedite the completion of an optimum design. This will include modification of specifications to conform to practical considerations, and the collection of information for the preparation of documents required for approval of construction.

6.9.7 Task 5.6.4 Fabrication, installation and initial testing

As soon as the final design of each subsection of the facility is completed and approved, materials will be ordered and fabrication started in order to complete the installation during FY 1977. Initial testing will be performed by circulating aqueous solutions or some other liquid that matches the rheological properties of molten fuel salt. These tests will include the calibration of the volumes of various vessels and verification of flows calculated from design specifications. Flow tests of the more complex transducers will be performed concurrently.

6.9.8 Task 5.6.5 Operation

The facility will be charged first with purified MSBR carrier salt and used to test transpiration devices, particularly the one designed for the determination of oxide. Oxide will be adjusted by standard addition to concentrations both above and below precipitation levels. Later, the oxide will be removed by hydrofluorination and similar tests will be performed after addition of UF_4 to determine effects of this less-soluble oxide. The facility will have the capability of delivering

several salt streams for the concurrent testing of different devices. Because many of the tests require the addition of constituents that cannot readily be removed from the salt, a careful sequencing of experiments will be required to achieve effective and economical utilization of the facility. Accordingly, long-term schedules will be devised to perfect analytical devices and accommodate the experiments of others in the most efficient sequence that is consistent with the needs of the Program. When applications to fuel salts have been exhausted, modification to permit usage with NaF-NaBF₄ or an alternate coolant will be made, and a similar but briefer program will be started. It is not expected that the same facility can be adapted to molten lithium chloride. Rather, a more modest facility will be assembled from ceramic materials, if necessary.

6.10 TASK GROUP 5.7 SPECIAL STUDIES

6.10.1 Objective

The objectives of work in this task group are fourfold: first, to develop and assess the value of methods which, by virtue of their advanced nature, or multidisciplinary character, cannot be logically assigned to any of the previous task groups; second, to perform experiments to which specialized analytical capabilities are peculiarly suited; third, to automate analytical methods and the acquisition and processing of data through the use of digital computers and to apply developed methods in support of activities of the Program; fourth, to select a rational combination of in-line and discrete-sample analytical methods that will assure optimum chemical surveillance of experimental and power reactors. Predicted activities in this task group are described in the following subtasks. It is expected that some expansion of special studies, particularly in the areas of the first objective, will result from new technological developments in analytical chemistry.

6.10.2 Schedule

The schedule for work in this task group is shown in Table 6.10.2.

6.10.3 Funding

Operating fund requirements for work in this task group are shown in Table 6.10.3.1, and capital equipment fund requirements are shown in Table 6.10.3.2.

6.10.4 Facilities

No additional facilities will be required for work in this task group.

Table 6.10.2. Schedule for work in Task Group 5.7 - Special studies

	Fiscal year											
	1975	1976	1977	1978	1979	1980	1981	1982	1983	1984	1985	1986
5.7.1 Special electrochemical investigations												
5.7.1.1 Pulsed techniques												
5.7.1.2 Stripping techniques												
5.7.2 Special optical investigations												
5.7.2.1 Radiolytic oxygen removal												
5.7.2.2 Laser raman spectra												
5.7.2.3 Time-resolved raman												
5.7.2.4 Infrared emission spectra												
5.7.2.5 Radioisotopic light sources												
5.7.2.6 Optoacoustic methods												
5.7.3 Spectroelectrochemical methods												
5.7.3.1 Unusual oxidation states												
5.7.3.2 Transient species												
5.7.4 Automated applications												
5.7.5 Evaluation of analytical methods for reactor application												
5.7.5.1 Fuel system												
5.7.5.2 Processing system												
5.7.5.3 Coolant system												

Table 6.10.3.1. Operating fund requirements for Task Group 5.7 - Special studies
(costs in 1000 dollars)

	Fiscal year											
	1975	1976	1977	1978	1979	1980	1981	1982	1983	1984	1985	1986
5.7.1 Special electrochemical investigations												
5.7.1.1 Pulsed techniques	2	8	9	10	12							
5.7.1.2 Stripping techniques	2	7	7	7	7	10	10	15				
Subtotal 5.7.1	4	15	16	17	19	10	10	15				
5.7.2 Special optical investigations												
5.7.2.1 Radiolytic oxygen removal		2										
5.7.2.2 Laser raman spectra		2	6	7	7							
5.7.2.3 Time-resolved raman				5	7	15	15					
5.7.2.4 Infrared emission spectra		1	4	4	6	12						
5.7.2.5 Radioisotopic light sources		1	4	4	5							
5.7.2.6 Optoacoustic methods				3	4	15	20					
Subtotal 5.7.2		6	14	23	29	42	35					
5.7.3 Spectroelectrochemical methods												
5.7.3.1 Unusual oxidation states	1	1	4	4	5							
5.7.3.2 Transient species		1	3	3	4							
Subtotal 5.7.3	1	2	7	7	9							
5.7.4 Automated applications	16	20	20	20	20	28	30	35	40	40	25	
5.7.5 Evaluation of analytical methods for reactor application												
5.7.5.1 Fuel system							5	30	35	50		
5.7.5.2 Processing system									5	20	60	
5.7.5.3 Coolant system								5	10	20	40	
Subtotal 5.7.5							5	35	50	90	100	
Total operating funds for Task Group 5.7	21	43	57	67	77	80	80	85	90	130	125	

Table 6.10.3.2. Capital equipment fund requirements for Task Group 5.7 - Special studies
(costs in 1000 dollars)

	Fiscal year							
	1975	1976	1977	1978	1979	1980	1981	1982
5.7 Miscellaneous items	9	38	6	10	18	80	5	
5.7.2.2 Laser raman spectrometer			50					
5.7.2.3 Time resolved raman spectrometer				50				
5.7.2.4 Fourier transform spectrometer					100			
Total capital equipment funds for Task Group 5.7	9	38	56	60	118	80	5	

6.10.5 Task 5.7.1 Special electrochemical investigations

The predominant electrochemical method used to date for molten-salt research and development studies, particularly for in-line applications, has been linear-scan voltammetry. Considerable effort has been devoted to developing suitable instrumentation and electrode combinations for these studies. Successful measurements have been made on electroactive species at the ppm concentration level. Problem areas, however, still remain. For example, suitable insulating materials which are compatible with molten fluorides would allow a more precise definition of electrode area and a corresponding improvement in the precision of the measurements. The search for better insulators will continue. As it becomes necessary to extend the electrochemical methods to lower concentration levels, particularly in relation to Task 5.2.2 (LiCl analysis), other electrochemical techniques will be investigated. Among these will be stripping techniques and pulsed techniques. The present instrumentation can be utilized in many instances for dc stripping applications; however, instrumentation for pulsed techniques will have to be developed. Commercial instrumentation for the latter which is suitable for in-line molten salt analysis is presently not available. Studies will be made to establish suitable guide lines for the fabrication of such electrochemical instrumentation. This will be followed by an evaluation of prototype instruments as applied to research melts and in-line applications.

6.10.5.1 Subtask 5.7.1.1 Pulsed techniques

The feasibility of applying pulsed techniques to molten salts has been demonstrated.⁷⁶ In this technique, a square wave or sine wave of small amplitude (millivolts) is superimposed on the voltage ramp that is applied to the indicator electrode. The attractive features of pulsed techniques are the increased sensitivity over linear-scan voltammetry, the ability to measure the Faradaic current in the virtual absence of charging current, and presentation of the current in the form of a symmetrical peak rather than the usual waves obtained with linear-sweep voltammetry. Pulsed techniques allow precise measurement of the peak height and exact location of the peak potential. Instrumentation for pulsed techniques requires various timing and sampling circuits, low-drift analog memories and good low-drift differential amplifiers. Satisfactory component parts are presently available; however, commercial instrumentation that can be used for research studies and in-line measurements in molten salts is not. Studies will be continued to establish suitable criteria for prototype instruments. Evaluation of such instruments will be made on both research melts and in-line situations involving fuel and coolant salts and also for measurements in molten LiCl.

6.10.5.2 Subtask 5.7.1.2 Stripping techniques

The electroanalytical stripping method, in which the current required to remove an electrolytically deposited product is measured, is a powerful technique for increasing the sensitivity and sometimes the selectivity of electroanalytical measurements. Improved sensitivity results from the fact that the quantity of deposited product, typically a plated metal, increases with plating time. Since the integrated current required to oxidize the metal is proportional to the equivalents deposited, much greater signals than obtainable by direct voltammetry can be produced by applying an anodic potential scan to an electrode that has been plated for extended periods. For direct current stripping, the most well-defined waves and highest sensitivities are obtained when the stripping voltage is increased at reasonably fast rates so that peak-shaped curves are obtained. In the pulse stripping mode, all of the considerations for dc stripping techniques apply. However, the far greater sensitivity and signal processing capability of the pulse detection technique yield cumulative improvements. Another valuable application of stripping techniques is in the measurement of a platable metal in the presence of another constituent which is reduced to a soluble species at a similar potential. Because the soluble species diffuses from the electrode, its reoxidation wave does not increase significantly with plating time, and after extended depositions the platable ion contributes a dominant signal to the stripping wave. This technique has been used to record measurable chromium waves in simulated MSRE fuel melts that contained a voltammetrically overwhelming concentration of UF_4 .²⁵

It is evident that stripping techniques will be needed to achieve the required sensitivities for the measurement of trace constituents, particularly bismuth at ppb levels. Enhancement of sensitivity has been demonstrated in quiescent research melts that contained a single platable ion. The application of stripping techniques to circulating melts in loops has been found subject to complications. At elevated temperatures, interactions (tentatively designated as alloying) frequently occur between different deposited metals or between a deposited metal and the noble-metal electrode. Alloying can generate complex stripping patterns that cannot, as yet, be interpreted quantitatively. Also, even moderate salt flow rates can increase plating rates significantly and thus compromise quantitative measurements. Conversely, selective alloying can sometimes be used to resolve closely spaced stripping waves.

A comprehensive program of theoretical and experimental studies will be undertaken to increase the understanding of practical aspects of stripping methods in molten fluoride media, and later in $LiCl$. Investigations will include the study of the stripping of co-deposited materials from a variety of electrode materials, the use of vibrating or rotating electrodes to minimize the effects of variations in flow, and consultations with materials specialists for understanding of alloying phenomena. Pulsed stripping techniques will also be investigated when appropriate instrumentation is available. The results of these studies will be used to effectively exploit stripping techniques for the in-line measurement of traces of metallic ions in MSBR melts. The use of stripping methods to study the alloying of noble-metal fission products with structural metals will be evaluated.

6.10.6 Task 5.7.2 Special optical methods

The activities of this task will be devoted to utilizing the in situ capabilities of spectrophotometric methods, and optical methods in general, (see Task 5.2.1) for special studies on MSBR melts. Included in these studies will be application of established spectral methods to investigation of significant chemical questions in radioactive fluoride melts and the assessment of the value of advanced techniques. As these latter techniques have had only limited application to fluoride systems, preliminary evaluation must be largely based on applications reported in other media.

6.10.6.1 Subtask 5.7.2.1 Investigation of radiolytic oxygen removal

The concentration of oxide determined in the MSRE fuel prior to criticality was about 100 ppm; after criticality and throughout the rest of MSRE operation the concentration was approximately 50 ppm. The higher initial value may well be attributed to errors in sampling and analysis, but the stable levels during operations must be considered as significant. On the basis of estimates⁷⁷ of the quantity of oxygen entering the system during maintenance, an 86 ppm increase in oxide concentration would have been expected — a value readily detectable by analysis. One hypothesis is that the oxide was converted by a radiolytic process either to the element or gaseous compounds, such as CO and CO₂, which resulted in reduction of oxide concentrations to steady-state or limiting levels. Below a critical temperature, radiolytic fluorine is liberated from solid fuels. Above this critical temperature the rate of recombination with reduced species in the fuel exceeds that of radiolysis and fluorine evolution ceases.⁷⁸ For the less electronegative oxygen, a higher critical temperature is expected, perhaps above the reactor operating temperature. The verification (and quantification) of this "self cleaning" hypothesis would have favorable implications to the inherent stability of molten-salt fuels.

A simple test of this hypothesis will be made by using internal alpha sources as a stand-in for in-reactor irradiation. The apparent relative solubility or rates of solution of oxides of isotopes of widely differing specific activities will be measured. Candidate compound pairs include ²⁴⁴Cm₂O₃ and ²⁴⁸Cm₂O₃, and ²³⁸PuO₂ and ²⁴²PuO₂. Individual compounds will be added to oxide-bearing melts of MSRE fuel solvent in the presence and absence of graphite. Radiolytic removal of oxide will result in the more rapid dissolution of the more active compound as evidenced by growth of its absorption spectrum, and perhaps changes of its spectrum as soluble oxycomplexes, such as PuO²⁺ are converted to fluorides. If positive results are obtained, more advanced experiments will be made in MSBR carrier salt with gas-analytical capabilities for the measurement of radiolysis products.

The initial work will be, in part, supported by the basic analytical research program in transuranium chemistry and will utilize Transuranium Research Laboratory facilities.

6.10.6.2 Subtask 5.7.2.2 Investigation of laser Raman spectra

The use of Raman spectroscopy for the study of polyatomic species in ionic melts is well established.^{79,80} By using "windowless" optical cells, this method has been extended to molten fluorides for the characterization of the BeF_4^{2-} ion⁸¹ in molten Li_2BeF_4 and other melts, as well as the $\text{Be}_2\text{F}_7^{3-}$ ion and higher polymers of beryllium fluorides.⁸² Quite recently⁸³ Raman spectra of melts containing AlF_3 at temperatures up to 1000°C have been obtained using a very simple experimental apparatus. Spectra of AlF_4^- and AlF_6^{3-} ions were well defined; effects of changing melt composition, temperature, and Al_2O_3 content (0.5-2.5 mole %) were investigated. At the present stage of development, the method is primarily useful for the characterization of polyatomic ions at concentration levels as low as 0.1 mole % or less when one of the elements involved has a high atomic number. In the MSR Program, Raman spectroscopy will be useful for the characterization and analysis of beryllium-, boron-, thorium-, and some uranium-containing species in fuel and coolant melts. If the resonance Raman effect is observed, much lower concentrations can be determined; for example, it was possible⁸⁴ to obtain the resonance Raman spectrum of UO_2^{2+} ion at concentrations of <60 ppm in molten LiCl-KCl . The laser Raman approach is particularly attractive because it is the only technique which offers promise for the in-line determination of major constituents of the fuel solvent, such as BeF_2 and ThF_4 .

A systematic investigation of laser Raman spectra of fluoride melt compositions of interest to the MSBR Program will be undertaken with emphasis on quantitative aspects. Absolute accuracy of better than 0.5% should be feasible with modern instrumentation. Analytical procedures for the in situ determination of total uranium, beryllium, thorium, and plutonium will be developed. This work will be accompanied by studies of minor constituents, possibly some oxygenated species in the coolant salt and lithium chloride, as well as protactinium and tellurium in the fuel salt. In addition to the development of analytical procedures, the Raman studies will result in increased understanding of the structure of melts of interest to the MSR Program.

6.10.6.3 Subtask 5.7.2.3 Time-resolved Raman spectroscopy

The major remaining problem in Raman spectroscopy is elimination of fluorescent background.⁸⁵ This problem may be acute in the detection of a weak Raman feature of colored or impure samples, and must be solved before the simple Raman techniques used for the characterizations of major polyatomic constituents in melts will become generally applicable to the determination of minor constituents. In a potentially successful approach,⁸⁵ a pulsed laser excitation source is used to achieve temporal resolution between the short-lived Raman signal (vibrational lifetimes on the order of 10^{-13} to 10^{-11} sec) and the relatively long-lived fluorescence signal (fluorescence lifetimes on the order of 10^{-9} to 10^{-7} sec). Further development work is necessary before this approach is routinely applicable in Raman spectroscopic studies. The application

of this approach to studies of ionic melts and other systems where fluorescence is a serious problem will be investigated. This subtask will be initiated shortly after proving the utility of Raman spectroscopy for the quantitative determination of major polyatomic species in melts of interest to the MSBR Program. Improvements in the precision of measurement of major species and in the detection limits for trace constituents will be evaluated.

6.10.6.4 Subtask 5.7.2.4 Infrared emission spectra

Determination of infrared spectra in addition to the Raman spectra is required in order to understand fully the interionic interactions in ionic melts containing polyatomic species. In addition to a more complete understanding of the structures of these melts, new and improved analytical procedures for certain polyatomic species should result from the measurement of infrared spectra of melt constituents. Complete characterization of major polyatomic constituents of melts by a combination of Raman and infrared measurements could fill a final gap in analytical capabilities by providing at least an indirect method for the estimation of lithium and fluoride concentrations.

Recently,⁸⁶ infrared emission spectra of molten nitrates and chlorides were obtained with a Fourier transform spectrometer (FTS). This approach eliminates the necessity for contacting the melt with an optical material. With the FTS, either the spectra can be recorded quite rapidly or the results of many scans can be readily averaged using an on-line computer which is part of the FTS. It is also possible to detect dissolved species in low concentrations when they exhibit strong infrared bands in a spectral region that is not overlapped by bands of the solvent.

The work will involve the development of techniques suitable for molten fluorides and fluoroborates. In the latter case, the volatility of the melt will have to be taken into account. After characterization of species present in melts of interest to the MSR Program, the development of analytical procedures for desired major species and the extension of this work to minor constituents will be undertaken. Fourier transform infrared spectra of gaseous constituents in equilibrium with fluoroborate melts will also be obtained. These results should be of considerable value for complete understanding of the chemistry of coolant melts.

6.10.6.5 Subtask 5.7.2.5 Radioisotopic light sources

Optical radiation generated from radioactive sources can be measured with high and predictable precision by photon counting techniques and the application of counting statistics. A theoretical and experimental application of this principle to improved photometric analysis has been developed using beta-activated scintillators as light sources.⁸⁷ Recently, in basic analytical research on transuranium chemistry, it was discovered that crystals doped with α -emitters can function as isotopic light sources at temperatures at least as high as 500°C. Such

sources would be ideally suited for precise absorptiometric measurements of optical radiation of predictable intensity that can be generated close to the point of measurement. Moreover, these sources exhibit sharp peaks in intensity that would aid in discrimination against radiation from the melts themselves. Basic research in the study of these high-temperature sources, in part supported by other analytical research programs, will be supplemented by conceptual designs and experimental models of devices to exploit this phenomenon. After such devices are evaluated in applications to non-radioactive streams of the Program, the effects of radiation on the sources will be evaluated, both for the generation of extraneous emissions and for damage to the crystal structure of the phosphors.

6.10.6.6 Subtask 5.7.2.6 Optoacoustic methods

The optoacoustic method is a new and powerful concept for gas analysis based on the fact that radiant energy absorbed by constituents of a gas mixture is usually converted to thermal energy in the gas phase. During transmission of modulated monochromatic radiation, thermal expansions from selective absorptions by constituents are converted to sonic signals of intensity directly proportional to the concentration of the absorbing species. By using laser sources, sensitive microphones, and computer processing of signals, this technique has been used for a commercial instrument that will automatically measure up to 10 atmospheric contaminants at ppb levels at five minute intervals.⁸⁸ Methods based on this principle would be of great value to the multicomponent analysis of MSBR gas streams, particularly coolant cover gases, but would require development of compatible optical and acoustical components. The potential of applications in this area will be evaluated from gas absorption data generated by other subtasks. Devices for its application will be developed, either as new instruments or as modifications of commercially available equipment.

6.10.7 Task 5.7.3 Spectroelectrochemical studies

In order to understand the chemical nature of melts of interest to the MSBR program in both a thermodynamic and kinetic sense, the nature, stability, and mode of formation of various oxidation states of solute species in these and related salts must be known. Electrochemistry provides a clear and relatively efficient means to generate various oxidation states of species of interest. This is an indirect technique, however, in that the identity of the product species can only be inferred and even then the inference can only be made when the electrochemical reactions occur under conditions dictated by the medium of measurement, e.g., voltammetric melt limits. Conversely, spectral techniques can be used to characterize species that can be generated with low current efficiency or in a transient state outside useful electrochemical limits. Spectroscopy is a direct technique for identifying species in that the theory is reasonably well advanced so that the identity, coordination, and oxidation state of amenable dissolved species can be derived from a given absorption spectrum. The simultaneous use of electrochemistry and spectroscopy in a given experiment, therefore, can yield considerably more information than either technique will yield when used alone.

6.10.7.1 Subtask 5.7.3.1 Characterization of unusual oxidation states

A knowledge of the basic chemical characteristics of all possible oxidation states of many solutes that will be present in fluoride and chloride melts is needed to predict reactions that may occur during operation of molten-salt reactors. Spectral examination of electrochemically generated species in higher and lower oxidation states than are thermodynamically stable in MSBR streams has been demonstrated to be a useful tool for such studies.⁸⁹ This technique will be used to characterize possible unusual oxidation states for various transition ions including corrosion products, lanthanides, transuranic elements and certain nonmetallic elements such as iodine and tellurium. Measurements of transuranic elements will also be supported by another program for basic analytical research. When necessary, measurements will be made in other molten salt media; e.g., KHF_2 , to obtain sufficient stability for complete spectral characterization. Studies of the less-stable species in MSBR compositions will be performed in the following subtask.

6.10.7.2 Subtask 5.7.3.2 Characterization of transient species

This subtask is closely related to the previous subtask and to various tasks associated with the effects of radiation on analytical methods. In the chemistry of radioactive MSBR salts many unstable and, therefore, transient species can be postulated. In the fissioning process very strong transient oxidants are formed, for example, a fission product nucleus stripped of a large fraction of its electrons. Also, the number of valence electrons of nonnuclear constituents may be altered by collision with energetic particles. In returning to more stable oxidation states these highly charged particles must traverse electron configurations corresponding to unusual oxidation states. Since little is known concerning homogeneous reaction rates in the fuel, it is possible that especially the more dilute constituents could be present at steady-state in an oxidation distribution that differs significantly from equilibrium values. Such conditions could result in interferences to in-line measurements by introducing unexpected spectral absorptions and compromising potentiometric measurements.

Spectroelectrochemical methods will be used to investigate potential interferences using techniques similar to those applied to the characterization of unusual oxidation states. In this case, the species will be generated in a deliberately hostile environment, for example, unstable oxidized species would be generated in a reducing melt. Spectral measurements in the immediate vicinity of the electrode (using a carefully focused beam from a tunable laser) will be used to provide estimates of reaction rates and predictions of possible effects on analytical methods. More sophisticated electroanalytical approaches (such as the ring-disc electrode system for the study of unstable species) will be coupled with spectral systems to provide additional measurements. Data obtained will be used to design experiments and interpret results for Task 5.2.4, Effects of radiation on optical components and spectra.

6.10.8 Task 5.7.4 Automation and application of analytical methods

The value of computers to in-line measurements has been demonstrated by the application of a PDP-8I mini-computer to the measurement of U^{3+}/U^{4+} ratios in fuel salt in a thermal convection loop. Automated 24-hour operation was achieved with about a 5-fold improvement in precision and a more convenient presentation of data. It is evident that comparable improvements can be achieved by automation and data processing operations for analyses in all the methodology categories of the Program. Programming activities will be started on the arrival of a replacement computer which has increased capacity to control a variety of analytical equipment on several installations. Also included in the activities of this task will be the application of established in-line methods, either automated or manually operated, in support of activities of the Program. This will include needed modifications for special installations, but will not include further basic development studies performed at the installation.

6.10.9 Task 5.7.5 Evaluation of analytical methods for an integrated reactor surveillance system

The purpose of this activity is to develop an overview of reactor requirements and analytical capabilities to assure that all needed methods are established in a form that is consistent with the needs for chemical surveillance of experimental and power reactors. Similar evaluations are, of course, informally in progress and will continue during the course of selection and development of methods; however, this task will incorporate the systematic practical assessment of methods after their capabilities and limitations are established. With input from Chemical Research and Development, Reactor Safety, Reactor Design and Analysis, Reactor Technology, and Maintenance, decisions will be made on the need for in-line analysis of the various streams, the degree of redundancy for such analyses, the hot-cell requirements for other methods, and back-up or reference analyses. Also included will be practical considerations such as the selection of locations for analytical devices that are consistent with required response times and maintenance accessibility, multiple containment of penetrations to meet safety requirements, criteria for proof testing of the devices, the establishment of a quality control program, and the interfacing of the automatic control and output of the devices with the computer system of the reactor.

The general approach will be to select, in consensus with other disciplines, those chemical variables for which reliable analyses are essential to safe reactor operation and then recommend devices and methods that will provide adequate measurement of these variables. The installation of a multiplicity of devices for the measurement of a critical variable may be recommended for test reactors. A reduction in redundancy of measurements is expected for a demonstration plant after the reliability of the devices has been established in nuclear operations in a test reactor.

After the critical needs of the reactor are fulfilled, the value of other in-line analytical determinations will be evaluated on a cost-benefit basis. Computer models of reactor systems will be used to establish the effects of off-design operations on performance parameters such as breeding ratio and increased fuel inventory and to compare this cost with those of installed analytical devices. It should be noted that many of the proposed analytical devices can be modified to perform additional analyses at nominal cost.

6.10.9.1 Subtask 5.7.5.1 Fuel system

Methods for the analysis of reactor fuel are the most completely developed; therefore, evaluation for the primary system will be started whenever the capabilities of an adequate fraction of the critical in-line methods are demonstrated in application to the reference fuel. This activity will then serve as a model for evaluation of methods for the other systems. Critical determinations will include oxide, U^{3+}/U^{4+} ratios or other redox potential measurements, total uranium, and key corrosion products.

6.10.9.2 Subtask 5.7.5.2 Processing system

Since the processing system is still subject to extensive development studies, general evaluation of methods in this area will have to be delayed. Known critical determinations include protactinium in the salt stream fed to the processing plant, and redox potential, protactinium, uranium, bismuth, corrosion products and possibly oxide in the return stream. Oxide in lithium chloride and some indicator extractants may later be included as critical determinations for the rare-earth separation system.

6.10.9.3 Subtask 5.7.5.3 Coolant system

Evaluation will be started when methods are established for the coolant that is finally selected for the reactor. Critical determinations will include key corrosion products and determinations associated with the distribution of tritium in the coolant system.

REFERENCES FOR SECTION 6

1. R. E. Thoma, *Chemical Aspects of MSRE Operation*, ORNL-4658 (December 1971).
2. R. H. Powell and O. Menis, "Separation of Fluoride from Refractory Materials by Pyrohydrolysis," *Anal. Chem.* 30: 1546 (1958).
3. A. D. Horton and P. F. Thomason, "Polarographic Determination of Sulfate," *Anal. Chem.* 23: 1859 (1951).
4. G. Goldberg, A. S. Meyer, Jr., and J. C. White, "Determination of Oxides in Fluoride Salts by High-Temperature Fluorination with Potassium Bromotetrafluoride," *Anal. Chem.* 32: 314 (1960).
5. D. L. Manning, W. K. Miller, and R. Rowan, *Methods of Determination of Uranium Trifluoride*, ORNL-1279 (May 25, 1952).
6. *ORNL Master Analytical Manual Section 2, Radiochemical Methods*, TID-7015 (1957).
7. "Automatic Continuous Analysis of Helium," *GCR Quar. Progr. Rept. Dec. 31, 1959*, ORNL-2888, pp. 178-184.
8. A. S. Meyer, *Methods for Analysis of MSRP Samples and Process Streams*, ORNL-CF-72-7-16 (July 12, 1972).
9. R. E. Thoma, *Chemical Aspects of MSRE Operation*, ORNL-4658 (December 1971), p. 27.
10. R. B. Gallaher, *Operation of the Sampler-Enricher in the Molten-Salt Reactor Experiment*, ORNL-TM-3524 (Oct. 1971).
11. *MSR Program Semiann. Progr. Rept. Feb. 28, 1966*, ORNL-3936, p. 154.
12. R. F. Apple, Method No. 9021206 (March 16, 1965), *ORNL Master Analytical Manual*, TID-7015 (Suppl. 8).
13. *MSR Program Semiann. Progr. Rept. Feb. 28, 1967*, ORNL-4119, p. 158.
14. R. E. Thoma, *Chemical Aspects of MSRE Operation*, ORNL-4658 (December 1971), p. 96.
15. *MSR Program Semiann. Progr. Rept. Feb. 28, 1969*, ORNL-4396, p. 200.
16. *MSR Program Semiann. Progr. Rept. Feb. 28, 1969*, ORNL-4396, p. 202.
17. *MSR Program Semiann. Progr. Rept. Aug. 31, 1968*, ORNL-4344, p. 196.
18. *MSR Program Semiann. Progr. Rept. Feb. 28, 1970*, ORNL-4548, p. 183.

19. *MSR Program Semiann. Progr. Rept. Aug. 31, 1968*, ORNL-4344, p. 36.
20. A. Houtzeel and F. F. Dyer, *Gamma Spectrometric Studies of Fission Products in the MSRE*, ORNL-3151 (August 1972).
21. *MSR Program Semiann. Progr. Rept. Feb. 28, 1969*, ORNL-4396, p. 208.
22. *MSR Program Semiann. Progr. Rept. Aug. 31, 1968*, ORNL-4344, p. 192.
23. D. L. Manning, G. Mamantov, "Rapid Scan Voltammetry and Chronopotentiometric Studies of Iron in Molten Fluorides," *J. Electroanal. Chem.* 7: 102-108 (1964).
24. *MSR Program Semiann. Progr. Rept. Aug. 31, 1971*, ORNL-4728, p. 75.
25. *MSR Program Semiann. Progr. Rept. Feb. 29, 1972*, ORNL-4782, p. 79.
26. *MSR Program Semiann. Progr. Rept. Feb. 28, 1971*, ORNL-4782, p. 135.
27. *MSR Program Semiann. Progr. Rept. Feb. 29, 1972*, ORNL-4782, p. 77.
28. *MSR Program Semiann. Progr. Rept. Feb. 28, 1969*, ORNL-4396, p. 201.
29. *MSR Program Semiann. Progr. Rept. Aug. 31, 1969*, ORNL-4449, p. 157.
30. L. E. McNeese, *The Development Status of Molten Salt Breeder Reactors*, Chapter 11, ORNL-4812 (August 1972).
31. *MSR Program Semiann. Progr. Rept. Aug. 31, 1971*, ORNL-4728, p. 74.
32. *MSR Program Semiann. Progr. Rept. Feb. 28, 1970*, ORNL-4548, p. 184.
33. *MSR Program Semiann. Progr. Rept. Aug. 1, 1970*, ORNL-4622, p. 115.
34. J. P. Young and J. C. White, "A High-Temperature Cell Assembly for Spectrophotometric Studies in Molten Fluorides," *Anal. Chem.* 31: 1892 (1959).
35. J. P. Young, "Windowless Spectrophotometric Cell for Use with Corrosive Liquids," *Anal. Chem.* 36: 390 (1964).
36. *MSR Program Semiann. Progr. Rept. Aug. 31, 1965*, ORNL-3872, p. 145.
37. *MSR Program Semiann. Progr. Rept. Aug. 31, 1968*, ORNL-4344, p. 168.
38. *MSR Program Semiann. Progr. Rept. Aug. 31, 1969*, ORNL-4449, p. 161.
39. *MSR Program Semiann. Progr. Rept. Aug. 31, 1971*, ORNL-4728, p. 71, U.S. Pat. No. 3,733,130.
40. *MSR Program Semiann. Progr. Rept. Feb. 28, 1967*, ORNL-4119, p. 163.

41. MSR Program Semiann. Progr. Rept. Aug. 31, 1966, ORNL-4037, p. 193.
42. MSR Program Semiann. Progr. Rept. Feb. 28, 1967, ORNL-4119, p. 164.
43. MSR Program Semiann. Progr. Rept. Feb. 28, 1971, ORNL-4676, p. 94.
44. MSR Program Semiann. Progr. Rept. Aug. 31, 1971, ORNL-4728, p. 73.
45. MSR Program Semiann. Progr. Rept. Feb. 28, 1971, ORNL-4676, p. 136.
46. MSR Program Semiann. Progr. Rept. Aug. 31, 1968, ORNL-4344, p. 188.
47. MSR Program Semiann. Progr. Rept. Aug. 31, 1967, ORNL-4344, p. 189.
48. MSR Program Semiann. Progr. Rept. Aug. 31, 1967, ORNL-4191, p. 173.
49. MSR Program Semiann. Progr. Rept. July 31, 1964, ORNL-3708, p. 328.
50. MSR Program Semiann. Progr. Rept. Feb. 28, 1969, ORNL-4396, p. 207.
51. MSR Program Semiann. Progr. Rept. Aug. 31, 1971, ORNL-4728, p. 72.
52. MSR Program Semiann. Progr. Rept. Aug. 31, 1971, ORNL-4728, p. 69.
53. MSR Program Semiann. Progr. Rept. Feb. 28, 1971, ORNL-4676, p. 138.
54. MSR Program Semiann. Progr. Rept. Feb. 29, 1972, ORNL-4782, p. 78.
55. Anal. Chem. Div. Ann. Progr. Rept., ORNL-4930 (September 30, 1973), p. 25.
56. D. Cubicciotti, "Thermodynamic Properties of Bismuth Trifluoride," *J. Electrochem. Soc.* 115: 1138 (1968).
57. M. S. Foster, C. E. Crouthamel, D. M. Gruen, and R. L. McBeth, "Solution of Li_3Bi , an Intermetallic, in Molten Chloride and Lithium-Chloride-Lithium Fluoride," *J. Phys. Chem.* 68: 980 (1964).
58. MSR Program Semiann. Progr. Rept. Feb. 28, 1969, ORNL-4396, p. 139.
59. G. Ting, "Thermodynamic and Electrochemical Studies of Niobium in Molten Fluorides and Chloroaluminates," Ph.D. Thesis, University of Tennessee, 1973.
60. H. W. Jenkins, Gleb Mamintov, and D. L. Manning, "E.M.F. Measurements on the Nickel-Nickel (II) Couple in Molten Fluorides," *J. Electroanal. Chem.* 19: 385 (1968).
61. H. A. Laitinen and C. H. Liu, "Electromotive Force Series in Molten Lithium Chloride-Potassium Chloride Eutectic," *J. Am. Chem. Soc.* 80: 1015 (1958).

62. H. A. McLain, "The CSTF Deuterium Experiment for the MSR Program," MSR-73-16 (January 26, 1973).
63. L. B. Sybrandt and S. P. Perone, "Computerized Pattern Classification of Strongly Overlapped Peaks in Stationary Electrode Polarography," *Anal. Chem.* 44: 2331 (1972).
64. *MSR Program Semiann. Progr. Rept. Feb. 29, 1972*, ORNL-4782, p. 57.
65. *MSR Program Semiann. Progr. Rept. Feb. 28, 1967*, ORNL-4119, p. 163.
66. C. E. Bamberger, R. G. Ross, C. F. Baes, Jr., and J. P. Young, "Absence of an Effect of Oxide on the Solubility and the Absorption Spectra of PuF_3 in Molten- $\text{LiF}-\text{BeF}_2-\text{ThF}_4$ and the Instability of Plutonium (III) Oxyfluorides," *J. Inorg. and Nuc. Chem.* 33: 3591 (1971).
67. *MSR Program Semiann. Progr. Rept. Feb. 29, 1972*, ORNL-4782, p. 84.
68. R. E. Thoma, *Chemical Aspects of MSRE Operation*, ORNL-4658 (December 1971), p. 33.
69. *Anal. Chem. Div. Ann. Progr. Rept.*, ORNL-4930 (September 30, 1973), p. 31.
70. *MSR Program Semiann. Progr. Rept. Aug. 31, 1971*, ORNL-4728, p. 73.
71. H. W. Morgan, personal communication.
72. *Anal. Chem. Div. Ann. Progr. Rept.*, ORNL-4930 (September 30, 1973), p. 29.
73. R. E. Thoma, *Chemical Aspects of MSRE Operation*, ORNL-4658 (December 1971), p. 30.
74. A. Houtzeel and F. F. Dyer, "Gamma Spectrometric Studies of Fission Products in the MSRE", ORNL-3151 (August 1972), p. 28.
75. *MSR Program Semiann. Prog. Rept. August 31, 1967*, ORNL-4191, p. 170.
76. *Anal. Chem. Div. Ann. Prog. Rept.*, ORNL-4930, (September 30, 1973), p. 30.
77. R. E. Thoma, *Chemical Aspects of MSRE Operation*, ORNL-4658 (December 1971), p. 76.
78. Kirslis, Copere, Jenks and Rainey, "Fluorine Evolution from Solid Fluorides Under Irradiation", *Reactor Chem. Div. Ann. Prog. Rept.*, January 31, 1964, ORNL-3591, p. 29.

79. R. E. Hester in *Advances in Molten Salt Chemistry*, vol. 1, J. Braunstein, G. Mamantov and G. P. Smith, Eds., Plenum Press, 1971, p. 1.
80. D. E. Irish in *Ionic Interactions*, vol. 2, S. Petrucci, Ed., Academic Press, 1971, p. 187.
81. A. S. Quist, J. B. Bates and G. E. Boyd, "Raman Spectra of Tetrafluoroberyllate Ion in Molten Sodium Fluoride and Lithium Fluoride to 686°," *J. Phys. Chem.* 76: 78 (1972).
82. L. M. Toth, J. B. Bates and G. E. Boyd, "Raman Spectra of $\text{Be}_2\text{F}_7^{3-}$ and Higher Polymers of Beryllium Fluorides in the Crystalline and Molten State," *J. Phys. Chem.* 77: 216 (1973).
83. B. Gilbert, G. Mamantov, and G. M. Begun, paper in preparation.
84. B. Gilbert, private communication.
85. R. P. Van Duyne, D. L. Jeanmarie and D. F. Shriver, "Mode-Locked Lasser Raman Spectroscopy—A New Technique for the Rejection of Interfering Background Luminescence Signals," *Anal. Chem.* 46: 213 (1974).
86. J. B. Bates and G. E. Boyd, "Infrared Emission Spectra of Molten Salts," *Appl. Spectr.* 27: 204 (1973).
87. H. R. Ross, "New Concept in Precision Photometric Analysis Using a Radioisotopic Light Source," *Anal. Chem.* 38: 414 (1966).
88. L. D. Kreuzer, N. D. Kenyon and C. K. N. Patel, "Air Pollution: Sensitive Detection of Ten Pollutant Gases by Carbon Monoxide and Carbon Dioxide Lasers," *Science* 177: 347 (1972).
89. F. L. Whiting, G. Mamantov and J. P. Young, "Electrochemical Generation and Spectrophotometric Study of Solute Species in Molten Fluoride Media," *J. Inorg. Nucl. Chem.* 35: 1553 (1973).

7. REACTOR SAFETY

7.1 INTRODUCTION

A significant effort in the development of MSR's will be devoted to a comprehensive study of the safety of all aspects of such systems. In general, the work in this area proceeds from the assumption that if such reactors are constructed, they will be designed, built, and operated normally so as to avoid any significant risks to the public health and safety. In addition, it is assumed that the plants will be able to deal safely with a variety of upset conditions which might reasonably be expected to occur several times during the life of any given system. However, it is also assumed that low-probability events, or combinations of events, may occur with consequences that are more severe than those associated with the more probable occurrences. These postulated events and their consequences will be analyzed as completely as possible to help define the margins of safety that are applicable to normal operation as well as to more clearly establish the safety characteristics of molten-salt systems in highly abnormal circumstances.

7.1.1 Objectives

The primary objective of the work in reactor safety is to provide analyses of postulated accidents in progressively greater detail as the technology of molten-salt reactors evolves to ensure that the required degree of safety is achieved. It is anticipated that these accident studies will contribute to the definition of component, subsystem, and system safety requirements and, to some extent, to the establishment of design and performance criteria that will make the systems compatible with the overall safety objectives of the program.

Much of the technology that is developed within other areas of this Program is safety-related and will, therefore, be applied to the safety analyses that are performed. However, some aspects of the overall technology are uniquely identifiable with the question of reactor safety, e.g., material or system properties and characteristics under conditions that are encountered only during accidents. Thus, in situations where the required safety technology cannot be developed by reasonable extensions of established efforts within base-technology areas, it will be developed within the area of reactor safety. The objectives of such safety technology development efforts are to provide all of the information shown to be required for the comprehensive description of the safety of molten-salt reactor systems.

7.1.2 Scope

Studies within the area of reactor safety are concerned principally with the characteristics and behavior of materials, components, subsystems, and systems in abnormal circumstances that would be expected to occur very

infrequently, if at all, during the anticipated lifetime of any given plant. However, to the extent that the more normal operations of the plant define system conditions that may be affected by accidents, some consideration must also be given to the normal behavior. Existing safety and safety-related technology, developed either within the MSR program or within other foreign or domestic reactor safety programs will be assessed, adapted as required, and adopted for application to the safety effort whenever such adoptions are consistent with the overall program objectives. Additional safety technology will be developed within this area only when unique, specific needs are identified.

7.1.2.1 Task Group 6.1 Guidance studies

The work in this task group is directed toward the qualitative, quantitative, and ultimately probabilistic analysis of postulated safety-significant accidents in MSR systems. Initially such studies will be applied to the ORNL Reference Design MSBR.¹ However, as alternate designs are proposed and developed, they will be similarly analyzed to clearly define their safety characteristics.

Since the safety of MSR's has not been addressed completely to date, the initial efforts will examine all postulated accidents to permit clear identification of the low-probability but potentially high-consequence events that will establish the safety characteristics of these systems and help to define the needs for additional safety and safety-related technology. Detailed studies will be carried out primarily for those event sequences whose combined probability of occurrence and potential consequences qualify them as high risk events. Some studies will also be directed to the events with potentially very severe consequences to determine the limits of MSR safety. Events whose potential consequences do not reach safety significance will not be evaluated in detail.

These studies will rely extensively on analytical techniques, mathematical models, computer programs, and data that are developed in other task groups in this area as well as in other technology areas. However, special consolidated models and computer programs may be developed within this task group if they are uniquely applicable to comprehensive MSR safety studies.

An important product of the guidance studies is the identification of technology and data needs for successful achievement of the area objectives. It is anticipated that such safety and safety-related needs as are identified and justified in this task group will be fulfilled by activities in other task groups or technology areas.

7.1.2.2 Task Group 6.2 Fission product behavior

The effort under this task group will develop data and models to describe the behavior of fission products and tritium under conditions that are not encountered during either normal operation or reasonably anticipatable transient situations. To the extent that other primary-system materials

participate in the determination of fission-product behavior (e.g., formation of special chemical compounds or physical phases that contain fission products), this work will be coordinated with efforts in Task Group 6.3. Data and models developed in other technology areas will be adopted whenever possible. However, specialized tests may be performed to verify the applicability of base-technology data to accident conditions or to demonstrate the validity of extrapolation from base to accident conditions.

7.1.2.3 Task Group 6.3 Primary system materials

The work in this task group will develop data and models to describe the behavior, compatibility, and failure modes of primary system materials (structural metals, graphite, and salts) under severe conditions that may result from potentially high-consequence accidents. Only those mechanisms and processes that are not treated in other technology areas and are not amenable to extrapolation from base technology data, e.g., salt boiling and the dynamic effects of the massive mixing of salts, will be examined.

7.1.2.4 Task Group 6.4 Components and systems technology

Data and models will be developed to define the responses and failure modes of MSR components and systems under severe accident conditions that are peculiar to this reactor type. In areas of commonality, component and system safety technology that is developed in other reactor programs will be adopted and applied to MSR system counterparts. However, the unique nature of many MSR components and systems, as well as differences in conditions that may result from accidents, are expected to require some separate safety technology development.

7.1.2.5 Task Group 6.5 Safety instrumentation and controls technology

This task group is concerned with the identification of needs for and the development of specialized instruments and systems that are uniquely applicable to postulated safety-significant situations in MSR systems. Techniques and systems that are available or are developed to meet the needs for normal operation and protection of the plant will be examined to determine the degree to which they satisfy special safety needs. Equipment and systems development will be undertaken only in those areas where safety needs would not be met by other development activities.

7.1.2.6 Task Group 6.6 Maintenance technology

The technology for maintaining MSR's that is developed in other activity areas will be examined in the light of conditions that may prevail during and after high-risk accidents to determine if such accidents impose additional requirements on the maintenance technology. In general, the activity in this task group will be limited to the identification of special conditions, operations, and performance requirements that must be addressed.

7.1.2.7 Task Group 6.7 Safety technology of processing and by-product storage and handling

Since the inventory of radioactive materials in an MSBR system is distributed throughout the complex, including the processing plant and short- and intermediate-term by-product storage facilities, full consideration will be given to the safety aspects of processing, storing, and handling MSR fuel and by-product materials. These studies will identify needs for and develop technology and methods required to protect against and mitigate the consequences of abnormal event sequences that could involve significant risks. The work will address primarily any special aspects that may arise from the facts that MSR materials and by-products may be dealt with in different physical and chemical forms from those handled at other nuclear facilities and that different mixes of potentially hazardous materials are involved (e.g., actinides and fission products are handled and stored separately outside the reactor but both may be in association with chemically toxic materials).

7.1.3 Relation to other technology areas

All other technology areas within the MSR program are strongly interrelated with the reactor safety area. However, as indicated above in the discussion of the scope of the safety activities, this area draws heavily upon the safety-related technology that is developed within other areas as well as upon relevant safety and safety-related technology that is developed within other reactor programs. Where practical, input and some support will be provided from the safety studies to ensure that technology is developed with sufficient capability, range, and accuracy to be directly applicable to safety work. Independent development of safety technology will be undertaken only if the required information is not expected to become available from other sources. However, independent assessments of technology developments from other areas will be performed to evaluate their applicability to safety considerations.

7.2 PROGRAM BUDGET AND SCHEDULE

7.2.1 Schedule

Work in the area of reactor safety is expected to continue throughout the MSR Program. As shown in Table 7.2.1, the initial activities are associated with the analysis of postulated accidents in various conceptual designs and the identification of needs for safety technology. Subsequently, work is initiated to develop technology that is not likely to become available through other reactor development activities. This work could extend beyond the time periods shown if additional needs are identified and justified. However, it is expected that most of the technology will be developed in other activity areas in the program and only minor efforts will be required to assess and adapt it for the safety program.

Table 7.2.1. Schedule for work on reactor safety

	Fiscal year												
	1975	1976	1977	1978	1979	1980	1981	1982	1983	1984	1985	1986	
6.1 Guidance studies													
6.2 Fission product behavior													
6.3 Primary systems material													
6.4 Component and systems technology (accident conditions)													
6.5 Safety instrumentation and controls technology													
6.6 Maintenance technology (post accident)													
6.7 Safety technology of processing and waste storage and handling													

7.2.2 Budget

The financial support required for the currently projected safety work is shown in Table 7.2.2. The initial funding for accident analyses anticipates studies of several concepts. Later in FY 1979, there is a decrease in this work as conceptual designs are being firmed up, and a subsequent increase for the very detailed analyses in support of the design and construction of particular systems. Only a small amount of support is shown for developing safety technology. Additional support may be needed for such work in the period beyond FY 1982 if technology needs not now identified must be satisfied. The projected funding is based on the assumption that, as the construction of reactors is undertaken, there will be a decreasing need for work in this area.

7.2.3 Key program milestones

The reactor safety effort is closely tied to the work associated with the development, design, and construction of reactors. Hence, the initial round of safety analyses should be completed in FY 1978 to provide a basis for the request for authorization of the MSTR and the MSTR mockup. The development of needed safety technology should be largely completed by FY 1983, so that it can be used in analyses to support licensing of the MSTR. Most of the safety analysis of the MSTR should be completed by 1985, when construction of that facility is projected to begin.

7.3 REQUIREMENTS, BACKGROUND, AND STATUS OF DEVELOPMENT

7.3.1 Safety requirements

The safety requirements, or safety performance criteria, that are applicable to MSR systems are presumed to be equivalent to the intent of similar requirements for nuclear facilities embodying other reactor concepts. Thus, from the standpoint of safety, it is assumed that the numerical guidance provided in 10 CFR 100 for doses from fission product releases applies to an entire MSR complex, which includes the chemical processing system and the on-site waste storage facilities.² (In the MSBR, all fuel reprocessing is carried out at the reactor site, thereby eliminating routine releases of radioactivity from other reprocessing facilities. While it is conceivable that some cognizance may have to be taken of this fact in evaluating routine releases from normal operation, it is not clear that similar considerations should be applied to safety analyses.)

Because of the fundamental differences between molten-salt reactors and other reactor types, it is reasonably clear that different safety provisions and engineered safety features will be required to help prevent and, ultimately, mitigate the consequences of major accidents. For example, it currently appears that emergency core cooling capability may not be required but that a highly reliable, and possibly redundant, drain-tank cooling system may be needed instead. Accurate descriptions of the safety requirements of MSR's will be developed from the detailed safety studies to be performed.

Table 7.2.2. Summary of operating fund requirements for work on reactor safety
(costs in 1000 dollars)

	Fiscal year											
	1975	1976	1977	1978	1979	1980	1981	1982	1983	1984	1985	1986
6.1 Guidance studies	90	233	240	240	190	240	360	390	485	600	650	
6.2 Fission product behavior				30	45	60	45	45				
6.3 Primary systems material			30	90	70	100	30					
6.4 Component and systems technology (accident conditions)						120	160	165	210	250	250	
6.5 Safety instrumentation and controls technology							50	50	50	50	50	
6.6 Maintenance technology (post accident)								50	50	50	50	
6.7 Safety technology of processing and waste storage and handling								50	50			
Total reactor operating funds	90	233	270	360	305	520	645	750	845	950	1000	

7.3.2 Background

In discussing the safety considerations of importance in MSR's it will be convenient to treat three general areas - neutronic safety, which includes primarily those characteristics of the plant that determine the possible changes in the reactivity of the core and the resulting response of the nuclear power and the temperatures and pressures in the primary system; materials safety, in which the behavior and interactions of various materials in the system affect the safety consequences of important events; and systems safety, which includes the safety behavior of major subsystems, such as containment, as well as the system as a whole.

This section deals primarily with the ORNL reference design MSBR station, including the processing plant and the interim waste storage facilities. The purpose, however, is to delineate the important factors that must be considered for any molten-salt reactor. The emphasis is on events with potential safety significance but some discussion of less severe events is included to provide perspective.

7.3.2.1 Neutronic safety considerations

The general principles of neutronic safety are the same for all reactors. Small fluctuations in reactivity should produce only highly damped power oscillations that do not lead to larger excursions. Large, rapid increases in reactivity should be difficult to produce and be easily controlled before the resulting power excursions produce damaging temperature or pressure excursions. The characteristics of the MSBR plant are such that these principles can be satisfactorily met.

The continuous removal of fission products and the adjustment of the fissile inventory in the fuel salt during operation of the MSBR minimize the amount of excess reactivity that must be compensated by control rods and hence limit the potential for rapid increases in reactivity associated with this excess. In the reference-design MSBR, the maximum amount of excess reactivity that must be compensated by rods under normal conditions is expected to be less than 1% $\delta k/k$. Thus, the consequences of even the most severe control-rod accidents are not likely to reach safety significance.

The fissile material in the on-line processing system amounts to less than 1% of the reactor inventory. If all of this material could be returned to the reactor, the excess reactivity would be increased only 0.4% or less. Furthermore, conceivable rates of reactivity introduction are quite inconsequential,* so accidents involving this material are well below the range of safety concern.

*The rate of reactivity increase would be only $5 \times 10^{-5}\%$ $\delta k/k$ per second if the 3 liter/min salt stream from the processing plant to the 49,000-liter reactor fuel system contained twice the normal uranium concentration.

Decay of precursors in the fuel circulating outside of the core reduces the effective delayed-neutron fraction from 0.30% to 0.12% in an operating MSBR. Thus one result of a cessation of flow is a 0.18% $\delta k/k$ reactivity increase in a time on the order of the half-lives of delayed-neutron precursors. Somewhat larger reactivity effects of stopping and starting fuel circulation could result from the perturbations of temperatures and the effects of changing pressure on gas bubbles in the core.

The maximum effect of temperature changes is shown by the following argument to be quite manageable. The reactivity coefficient for changes in temperature of the entire core ($-0.9 \times 10^{-5} \text{ }^\circ\text{C}^{-1}$) is much smaller than the coefficient for the fuel alone ($-3.3 \times 10^{-5} \text{ }^\circ\text{C}^{-1}$ for a uniform change of fuel temperature over the entire core). Thus the upper bound on reactivity effects due to a temperature change in the core corresponds to cooling all the core fuel (and none of the graphite) from the maximum operating temperature (705°C) to the fuel liquidus temperature (500°C). This is only about 0.7% $\delta k/k$. Effects actually attainable are smaller and, because they can be produced only by inflow of cooler salt, occur with time constants of at least several seconds. The safety rod system is quite capable of preventing power excursions due to such effects.

Because of the strong absorptions in thorium in the fuel salt, displacement of a small fraction of the salt by voids has a positive effect on reactivity. There are, in principle, two ways this could occur: (1) by increases in the volume fraction of circulating, noncondensable gas, and (2) by boiling of the fuel salt (vapor pressure equals 1 atm at $\sim 1400^\circ\text{C}$). Neither of these processes appears to be capable of producing changes of sufficient magnitude to represent a safety problem.

Under normal operating conditions the fuel salt in an MSBR contains 0.2 to 1.0 vol % of helium bubbles. This gas is introduced and removed continuously to strip ^{135}Xe . Thus, changes in the rate of addition or removal or changes in system pressure will change the core void fraction. At 1 vol %, the voids in the reactor core represent about 0.039% in reactivity. A complete depressurization of the fuel system, which would allow these bubbles to expand by a factor of 2 to 3, would cause a reactivity increase of only about 0.1% $\delta k/k$. In addition to the bubbles, the salt contains some dissolved helium and the pores of the graphite contain substantially more. Although the total amount of helium in the graphite is large, the rate at which it can diffuse out is limited so that for reasonably attainable rates of pressure loss in an MSBR (~ 2 psi/sec) the combined reactivity effect due to bubble expansion and graphite outgassing is only 0.005 (% $\delta k/k$)/sec or less.

Voiding of a few channels by local boiling (as might result if flow blockages occurred in individual fuel passages) is not a severe event. The positive reactivity effect associated with 100 empty fuel cells* at the

*A fuel cell, as used here, means the 4 in. by 4 in. by 16 ft long region associated with a single moderator piece.

average nuclear importance for the central core region is less than 0.5% $\delta k/k$. Because the boiling temperature (at 1 atm) is more than 700°C above the normal operating temperature of the salt, the energy input required to heat the salt to the boiling temperature over a significant portion of the core in a short time would require a nuclear excursion larger than any produced by credible reactivity inputs. Thus, boiling in the core will not come into play as a positive reactivity feedback in any nuclear excursion originating with the reactor at or near normal temperature.

Displacement of small amounts of fuel salt by graphite produces a positive reactivity effect. At the center of the core (the most sensitive spot) the effect amounts to $2.9 \times 10^{-6}\%$ $\delta k/k$ per cm^3 . Conceivable events, including sudden redistribution of clearances in response to flow changes or accumulated stresses, produce no reactivity increase of much consequence.

A unique consideration in fluid-fuel reactors is the possibility of inhomogeneity of the fissile material in the circulating fuel. Specifically of concern is gradual segregation of fissile material outside the core, followed by rapid introduction with the incoming stream. The MSBR fuel salt is quite stable over a range of compositions and conditions much wider than the anticipated deviations. Segregation of uranium could conceivably be produced by introduction of reducing agents or oxygen into the salt, so adequate protection against this must be provided in the MSBR.

The response of the nuclear power to reactivity increases is governed by the temperature coefficients of reactivity and the action of the control rods and safety rods. Because the delayed neutron fraction is unusually small, the MSBR power responds rapidly to reactivity increases.

The reactivity coefficients for uniform changes in fuel and graphite temperatures are listed in Table 7.3.2.1. In response to reactivity transients, core temperature changes will not be uniform, however. In particular, the graphite will change temperature much more slowly than will the fuel salt. (In the central core region, graphite comprises about 90% of the heat capacity but only about 8% of the nuclear heat source is in the graphite.) Consequently, heating of the fuel salt results in a prompt, negative response of reactivity to a power excursion. This response is great enough to limit effectively the initial power surge caused by any credibly rapid increase in reactivity. Thus safety rods are not required to operate unusually fast. The total core temperature coefficient (fuel plus graphite) is quite small, however, and might conceivably be positive. (The calculated value is negative, but the current margin of uncertainty is such that the coefficient could turn out to be positive.) As a result, safety-rod action is required to prevent safety-significant variations in temperature that might otherwise result from any reactivity change that persists more than a few seconds.

In summary, the nuclear safety characteristics of the reference MSBR are such that a reactivity excursion leading to a breach in the primary system boundary appears to be highly unlikely.

Table 7.3.2.1. Coefficients of reactivity for uniform changes in temperature across the MSBR core

Component	Reactivity coefficient,
	$\frac{1}{k} \frac{\partial k}{\partial T}$ ($^{\circ}\text{C}^{-1}$)
	(x 10^{-5})
Fuel salt	
Doppler effect*	-4.37
Thermal base**	+0.27
Density	+0.82
Total fuel salt	-3.28
Graphite	
Thermal base**	+2.47
Density	-0.12
Total graphite	+2.35
Core	-0.87

* Primarily due to thorium.

** Upward shifts in thermal spectrum increase reactivity because fissile cross sections decrease less rapidly than the thorium cross section does.

7.3.2.2 Materials safety considerations

Although neutronically driven events appear to offer little likelihood of causing serious damage to the primary system of an MSR, other events and processes must be considered which might either cause such damage or increase the vulnerability of the primary system to damage. Among these are corrosion processes and possible interactions among the various materials of the primary, secondary, and steam systems.

Corrosion

Hastelloy N is corroded by MSBR fuel salt under normal conditions by reactions of the type

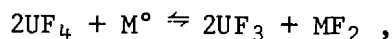

where M^0 represents any metal that is thermodynamically capable of reducing the U^{4+} ion. The ratio UF_3/UF_4 in the fuel salt is maintained at a value such that equilibrium is reached with concentrations of Ni^{2+} , Fe^{2+} , and Mo^{3+} in the salt that are much less than 1 ppm and a chromium concentration less than one hundred ppm. The predominant corrosion reaction then is reaction of UF_4 with chromium in the metal to form CrF_2 which dissolves in the salt. Chromium becomes depleted near the surface and, after the first few thousand hours, corrosion is limited by the rate of diffusion of chromium to the surface. At MSBR temperatures this limit is on the order of 0.1 mil/year of chromium depletion.

Introduction of moisture and air into the fuel system produces HF and metal oxides, which dissolve in the salt and make it more oxidizing and more corrosive to all constituents of Hastelloy N. During normal operation the contaminants can be kept low by controlling the composition of the cover gas. Maintenance operations will almost inevitably introduce some moisture, but with reasonable precautions to minimize air leakage, corrosion from this cause will have negligible effect on primary system integrity. (Corrosion in the MSRE fuel system, which was opened two or three times a year, averaged only 0.1 mil/year.)³ Thus, it does not appear that normal corrosion processes will be involved in safety considerations.

A somewhat related process that might conceivably affect the safety of MSR's is direct attack on the structural alloy by specific fission products - such as the intergranular attack by tellurium on Hastelloy N that was observed in the MSRE. While this particular problem will presumably be solved by efforts in other areas, studies will be needed to show that no similar problems exist in the system that is finally evolved.

Salt-graphite interactions

The graphite in the core of a molten-salt reactor is essentially an inert component under normal operating conditions. It is not subject to either

corrosive or erosive attack by the circulating salt. Since the salt does not wet graphite surfaces, there is no permeation of salt into the graphite pores and any tendency for such permeation would be further reduced if it were necessary to seal the pores to reduce xenon poisoning. However, some xenon (and other gases) will diffuse into the graphite and leave behind the products of radioactive decay. Additional fission products will be deposited on the graphite surfaces. Except for their contribution to afterheat (in the graphite) these fission products are not expected to affect the graphite structure, even under accident conditions.

Interactions between the salt itself, or its major constituents, and graphite have not been thoroughly examined for the conditions that might develop in a serious accident. The boiling of salt at or near graphite surfaces, as might occur under some core blockage conditions, has not been studied with respect to effects of either the boiling itself or the vapors that would be produced. Effects due to changes in salt chemistry as a result of introduction of foreign materials during accidents also have not been examined in detail.

Salt-to-salt interactions

The eutectic of NaBF_4 - NaF (92-8 mole %) was chosen as the secondary salt in the reference MSBR because it has reasonably good coolant properties, it is relatively inexpensive, and its melting point (725°F) is low compared to that of many other suitable fluoride mixtures. From the safety standpoint it is important that mixing of fuel and coolant salt should not give rise to situations that could endanger the health and safety of the public or of the operators of the plant.

One event that could produce mixing of fuel and coolant salts is a leak in a primary heat exchanger. The largest likely leak of this kind is believed to result from the rupture of one tube in one of the heat exchangers. Depending on the location of the rupture, coolant salt would enter the fuel salt in the primary system at an initial rate in the range of 0 to 3.5 lb/sec and fuel salt would enter the coolant salt at a rate in the range of 1.0 to 7.4 lb/sec. That the leak existed would be signaled by rapid loss in reactivity of the reactor or fission product radioactivity in a secondary circuit or both. Upon either of these signals the reactor would be shut down rapidly, the fuel salt would be drained from the primary system into the fuel salt drain tank, and the coolant salt in the affected secondary circuit would be drained into a coolant salt drain tank.

The amount of mixing of fuel and coolant salts would vary widely, depending on the design of the plant and the course of the event. We estimate that as much as 450 ft^3 of coolant salt could mix with 1700 ft^3 of fuel salt in the primary system and 40 ft^3 of fuel salt could mix with 2100 ft^3 of coolant salt in a secondary circuit of the reference MSBR. No chemical reactions that would generate excessive heat or precipitate constituents of either salt would be expected to occur on

mixing, however additional work will be required to adequately substantiate this expectation. Fuel salt and sodium fluoroborate are immiscible, however, so two salt phases would be present in both systems. Although the salts are immiscible, exchange occurs between the phases with lithium and beryllium fluorides entering the lighter fluoroborate phase and sodium fluoride and boron trifluoride moving into the fuel salt phase. Uranium and thorium fluorides remain in the heavy phase.

In the primary system the exchange of constituents between salts would not be expected to have a significant effect on the melting point of the fuel salt. The melting point of the coolant salt dispersed in the fuel would increase somewhat, some BF_3 would be released, and the BF_3 overpressure in the primary system would be expected to rise to about 5 atm. In the secondary system the interaction between the fuel and coolant salts would tend to raise the liquidus temperature of the fuel-containing salt but would not significantly affect the coolant salt. Since much of the secondary system normally operates at a temperature below the liquidus of the fuel salt, the fuel salt that leaked into the secondary system would initially be dispersed as frozen particles throughout much of one circuit. Whether the particles remained as solids would depend on measures taken to heat or cool the secondary circuit after the coolant salt had been drained.

Another mechanism for mixing coolant salt into the fuel salt (but not vice versa) is the failure of a secondary-salt line within the primary containment. Since the primary containment of the reference design funnels all salt spills to the fuel drain tank, such an event could quickly add a major fraction of the coolant-salt inventory of the affected loop to the fuel salt in the drain tank. If the four primary loops continued to circulate salt at full speed, the drain-tank contents would enter the primary system at about 650 gpm (~ 170 lb/sec). However, stopping the primary-pump motors and circulating the fuel salt with pony motors would allow removal of shutdown heat without incurring the salt mixing in the primary loop. In any event, it is likely that the two salts would eventually become mixed in the fuel drain tank. The consequences of mixing on this scale have not been examined in detail, but it is not expected that they would represent a significantly greater safety question than mixing via a failed heat-exchanger tube.

None of the conditions associated with mixing of fuel and coolant salts in the primary or secondary systems appear to be capable of producing a break in either system. The secondary circuits must be heavily shielded against the radioactivity present in the coolant salt during normal operation. This shielding can be made adequate to protect against the fission products that would be introduced by the fuel salt.

Salt-water interactions

Water and steam react with sodium fluoroborate to produce primarily hydrogen fluoride and sodium hydroxyfluoroborate. The reactions are not destructively exothermic, but the hydrogen fluoride is corrosive to the

metals of the reactor secondary system and the tubes that separate the fuel salt from the coolant salt. Although the corrosion rates are not catastrophic under any foreseeable circumstance, the leakage rate of water from the steam system into the secondary system and the hydrogen fluoride concentration in the secondary salt must be kept low in order to maintain a low corrosion rate of piping and equipment.

In the event of a rupture of one or more tubes in a steam generator or superheater, the rapid pressurization of the secondary system and the possibility of transmitting that pressure to the primary system is the major concern. Isolation valves must be provided to stop the flow of feedwater and steam to the faulty steam generating equipment and pressure relief devices must be provided on the secondary system to keep the pressure below the system design pressure. The steam and salt that are discharged through these devices must be contained but it has not been determined if the reactor primary containment or some other secondary system would be used.

Salt spills within the primary containment will not normally involve water except for traces in the containment atmosphere. However, subsequent opening of the containment for maintenance may admit sufficient moisture to allow some uptake by salt residues. In such cases it may be necessary to examine the long-term safety consequences of possible piping and containment corrosion by residual salt. Since the primary-containment liner may be water-cooled (much like the PCRV liner of an HTGR), assurance must be provided that the liner cooling water cannot be mixed with spilled salt. Such a double accident, with sufficient water, could lead to high containment pressures from steam generated from the sensible heat of the salt.

7.3.2.3 System safety considerations

The preceding sections included discussions of some particular aspects of safety technology and some specific postulated accidents. However, there are additional safety considerations that are important throughout the plant. Among these are the behavior of fission products in MSR systems and the engineered safety features of the plant.

Radionuclide decay heating

From the standpoint of reactor safety, the chief importance of radionuclide decay heat lies in whatever threat it may pose to the integrity of the primary system.

In an MSBR, the fission products and transmutation products and the heat produced by their decay are distributed through the reactor systems and the processing facility in a manner that depends on the physical features of the plant, the chemistry of the radionuclides, and the extent of re-processing of the fuel salt. In the reference design MSBR, after several

months of operation at its design power of 2250 MW(t), the total decay heat rate is about 152 MW, distributed as shown in Table 7.3.2.3.1. Most of the heat is generated in the fuel salt by the decay of all classes of radioactive products with half lives of a few minutes or less and of longer lived products that are soluble in the salt.

Krypton and xenon diffuse into the pores of the core graphite or into the helium bubbles that circulate in the fuel salt and are removed to the drain tank. About 80% of the energy of decay of the gases that reach the drain tank is released in the tank. The remainder is released in the carbon beds. For the purposes of conservative design, each daughter atom of a noble gas is assumed to deposit on the surface nearest the point of decay of the parent atom and there to release its heat. This certainly is the situation in the graphite and in the carbon beds. Depending on the design, daughter atoms born in the off-gas lines or drain tank could either be dissolved in fuel salt and returned to the primary system or be carried on with the gas stream.

The fission products from element 41, niobium, through element 52, tellurium, are not stable as metal ions under the normal redox conditions in the fuel salt and are rapidly reduced to the elemental state.* These metals are highly insoluble in the salt and are not wet by it, so they tend to deposit on metal and graphite surfaces and collect at gas-liquid interfaces. The distribution of the afterheat produced by these materials depends on their distribution among the various surfaces. Table 7.3.2.3.1 shows two calculated distributions for the afterheat from metallic fission products, reflecting uncertainties in their physical distribution. The first is based on an assumed sticking coefficient — that is, the probability that a fission-product atom remains on the surface to which it migrates — of 1.0 for metal and graphite surfaces and 0.1 for bubble surfaces. For the second distribution, the sticking coefficient for gas bubbles was increased to 1.0 and no reentrainment was allowed in the salt in the drain tank. The daughters of noble metals are also noble metals which tend to remain where the parent was deposited except for iodine, the daughter of tellurium. In the presence of flowing salt, iodine returns to the liquid phase; otherwise it remains on or near the surface at which it was formed.

The fuel processing system is the final location in which a substantial amount of radioactive decay heat is released. The source of heat there is roughly equally divided between ^{233}Pa and fission products of intermediate to long life. Decay heat generation is a most important factor in the design of this system. The operation of the processing system scarcely affects the decay heating in the reactor during operation, but does reduce the heating rates at longer times after shutdown (and decay of the shorter-lived fission products). From the foregoing, it is evident that three conditions of operation must be considered with regard to

* Because of this tendency to exist in the elemental state, these fission products are frequently referred to as "noble metals" in MSR's.

Table 7.3.2.3.1. Distribution of radionuclide decay heat
in a 1000-MW(e) MSBR plant

Location of heat source	Heat generation rate (MW)	
	Bubble sticking coefficient = 0.1	Bubble sticking coefficient = 1.0
Fuel salt — all classes of radioactive products	102	102
Graphite in reactor vessel		
Noble gases and daughters	1.4	1.4
Noble metal deposits	4.8	3.6
Metal surfaces in primary system — noble metal deposits	18	12
Drain-tank system		
Noble gases and daughters	9.9	9.9
Noble metals and daughters	1.2	8.3
Off-gas system — noble gases and daughters	2.4	2.4
Fuel reprocessing plant		
Fission products	6.6	6.6
Protactinium	5.0	5.0
Total	152	152

release and removal of decay heat; normal operation at various power levels, reactor shut down but fuel salt remaining in the primary system, and reactor shut down with fuel discharged to the drain tank. Only the last two of these are regarded as having potential safety significance. When the reactor is shut down, the radioactive decay heat decreases with time as shown in Fig. 7.3.2.3. In a normal reactor shutdown, the fuel salt is retained in the primary system for many hours, the primary pumps continue to operate at full flow on the normal electric supply or at 10% flow on pony motors driven by an emergency power supply. The secondary pumps also continue to operate at flows in the range of 10 to 100%, depending on the power supply. Heat is transferred from the primary salt to the secondary salt; steam is produced at much reduced rates in the steam generators and is discharged to the turbine condenser or to other coolers. With 10% of their rated normal flow, two primary loops and associated secondary loops will hold the temperature at or below the normal level until 5 minutes after shutdown when one loop combination is sufficient. In the absence of cooling, the temperature of the primary system would rise to 1400 and 1500°F in 70 and 120 minutes, respectively. The heat load in the drain tank begins to decrease immediately after such a shutdown. Heat production in the off-gas system decays more slowly and the heat production in the processing plant is little affected for several hours.

Under accident or other unusual circumstances the fuel salt is discharged to the drain tank for cooling. Discharge of salt from the primary system into the drain tank could begin at shutdown and be completed in about 7 minutes. At this time the heat production rate in the drain tank would be about 40 MW; the temperature of the salt would rise to a maximum of 1400°F in a few hours and then fall to about 1000°F in a few days, where it would be maintained by control of the cooling.

Conditions in the off-gas system and in the reprocessing plant would not be affected significantly by draining the reactor, but the conditions in the reactor primary system would be markedly different. Draining of the fuel salt would remove the fluid that transports the decay heat from the graphite to the primary heat exchangers. If the secondary salt were drained from the heat exchangers at the same time, the preferred means for removing the heat from the decay of noble metal deposits on the heat exchanger tubes would also be removed.

Calculations have shown that the components and piping in the primary system could be designed to be cooled adequately by providing a system that would maintain the cell walls at 1000°F. Heat would be transferred by radiation and conduction within the components and would be radiated to the cell walls. The temperature at the center of the graphite core in the reactor vessel of the reference design was estimated to reach a maximum of 1900°F after 14 hours, but the vessel walls would not exceed 1400°F. With some modifications of the current reference design, the center tubes of the primary heat exchangers would not exceed 2000°F, and the outer shell would not exceed 1400°F. Delaying the drain by 24 hours and cooling the plant to 1050°F during that time would reduce the decay heat rates by a factor of about 10 and would substantially reduce the temperature rise.

ORNL-DWG 72-8589

- A-FROM FISSION PRODUCTS IN THE PRIMARY SALT
 B-FROM THE NOBLE METAL FISSION PRODUCTS,
 (Nb, Mo, Tc, Ru, Rh, Pd, Ag, Sn, Sb, AND Te)
 C-FROM THE NOBLE GASES, Kr AND Xe, AND THEIR
 DAUGHTERS
 D-FROM ^{233}Pa AND LONGER LIVED FISSION PRODUCTS
 IN THE FUEL REPROCESSING PLANT

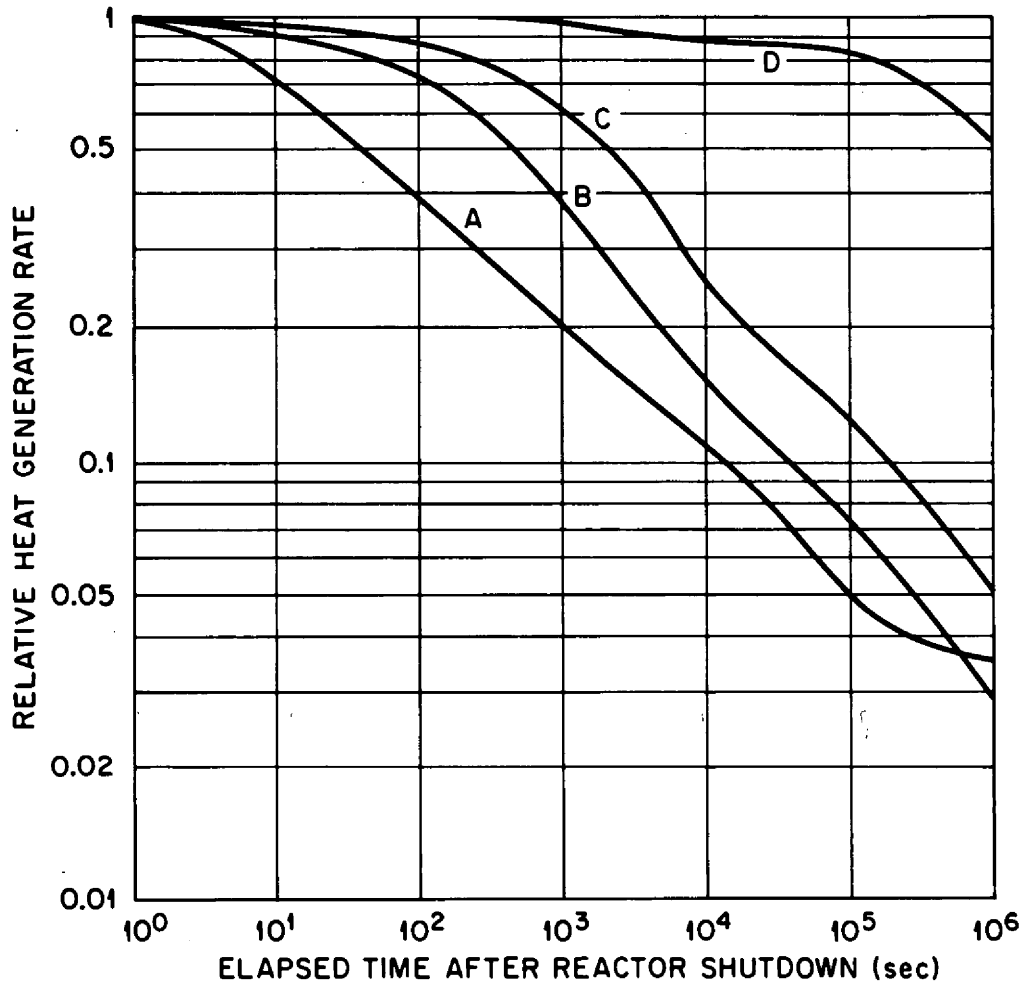

Fig. 7.3.2.3. Time dependence of decay heat sources in a 1000-MW(e) MSBR plant.

Release of fission products

The potential release of fission products through multiple barriers and their ultimate dispersion in the environment is a major safety consideration in MSR's as in any other nuclear system. The processes governing the behavior of fission products in the secondary containment, their leakage to the outside, and their dispersion for MSR systems are not expected to differ significantly from those in other systems. However, behavior in and releases from the primary system and the primary containment may be quite different. The chemical and physical form of the fission products, their location within the system, and the conditions resulting from accidents all may be expected to affect fission-product releases.

The fission products that are important from a radiological, or release, standpoint are not necessarily those that are most significant in after-heat considerations. For afterheat, all fission products with significant decay energy are important, while for radiological safety, the emphasis is on a more select group of biologically important radionuclides. For purposes of orientation, Table 7.3.2.3.2 gives the calculated inventories of some radiologically important nuclides (including actinides) in a MSBR system and in PWR and LMFBR systems of comparable size. The MSBR inventories are given just prior to shipment of high-level waste to a federal repository while the PWR and LMFBR inventories are given just prior to refueling. It is important to note the effect of continuous processing on the in-reactor inventories for an MSBR, as these are the inventories that would nominally be available for release during a reactor accident. The inventories associated with the processing plant and on-site storage facilities may not be ignored, but, because of their isolation from the reactor, separate consideration must be given to the different accidents that could lead to their release.

Many radionuclides, including such radiologically important species as Cs, Sr, and I, exist in stable ionic forms in MSBR fuel salt and, therefore, tend to remain in the salt even under upset conditions. However, it is also necessary to know their behavior under highly abnormal conditions where the salt may be subject to hydrolysis or to very high temperatures.

Another class of fission products, including the noble gases, is highly volatile under MSR conditions and will tend to be found in the off-gas system where release considerations again differ from those in the primary system. Daughters of the volatile nuclides, even though some of them may tend to dissolve in salt, will generally appear in the off-gas system, also. The amounts of Cs and Sr that lodge in the off-gas system will depend on precursor half lives and the rates of precursor removal.

Yet another class of fission products, the noble metals, are found in the elemental state throughout the reactor plant. Their importance from the standpoint of activity release arises from the fact that some, like tellurium, have important, volatile daughters (iodine, in this case). Thus, the release characteristics of deposited fission products must also be considered in safety studies.

Table 7.3.2.3.2. Comparison of maximum radionuclide inventories in 1000-MW(e) MSBR, PWR, and LMFBR power stations

Nuclide	Inventory (curies)			
	MSBR ^a		PWR ^b	LMFBR ^c
	Reactor	Processing plant		
⁸⁵ Kr	1.25	2.8 x 10 ⁶	6.4 x 10 ⁵	3.2 x 10 ⁵
⁹⁰ Sr	1.2 x 10 ⁵	2.9 x 10 ⁷	4.3 x 10 ⁶	1.3 x 10 ⁶
¹³¹ I	2.4 x 10 ⁷	3.5 x 10 ⁷	7.2 x 10 ⁷	8.2 x 10 ⁷
¹³³ I	9.7 x 10 ⁷	1.5 x 10 ⁷	1.3 x 10 ⁸	1.2 x 10 ⁸
¹³³ Xe	7.0 x 10 ³	1.1 x 10 ⁸	1.3 x 10 ⁸	1.5 x 10 ⁸
²³³ Pa	4.2 x 10 ⁸	1.6 x 10 ⁹		
²³⁹ Np			1.6 x 10 ⁹	3.2 x 10 ⁹
²³⁸ Pu	3.6 x 10 ³	2.6 x 10 ⁵	2.0 x 10 ⁵	7.1 x 10 ⁵
²³⁹ Pu	0.2	11	2.3 x 10 ⁴	1.4 x 10 ⁵
²⁴⁰ Pu	0.02	1.2	3.3 x 10 ⁴	1.7 x 10 ⁵
²⁴¹ Pu	0.45	33	7.1 x 10 ⁶	2.3 x 10 ⁷
²⁴¹ Am			1.1 x 10 ⁴	4.0 x 10 ⁴
²⁴³ Am			1.2 x 10 ³	1.3 x 10 ³
²⁴² Cm			2.0 x 10 ⁶	2.2 x 10 ⁶
²⁴⁴ Cm			1.6 x 10 ⁵	3.1 x 10 ⁴

^aReference MSBR described in ORNL-4541 (June 1971).

^b*Siting of Fuel Reprocessing Plant and Waste Management Facilities*, ORNL-4451 (July 1970).

^c*Aqueous Processing of LMFBR Fuels - Technical Assessment and Experimental Program Definition*, ORNL-4436 (June 1970).

Engineered safety features

Engineered safety features will be provided in all areas of MSR systems to interrupt the progression of accident sequences and to help limit the consequences of those events which may occur. An important safety feature, the use of primary and secondary containment for the reactor system, has been mentioned several times in this section. In addition, special containments will be provided for auxiliary systems such as the off-gas system, the processing plant, and the waste storage facilities. Still other safety features will be provided as their needs are established by continuing safety studies.

The most unusual of the engineered safety features in the MSBR is the provision for dealing with afterheat under accident conditions — the heat source is led to the cooling instead of vice versa (as in the ECCS for a light-water-cooled reactor). As described elsewhere, the bulk of the fission products stay in the fuel salt, making shutdown cooling for the fuel salt essential for prevention of excessive temperatures. The ultimate cooling system is in the drain tank, so the reactor and containment are designed so that the fuel will get to that tank under any credible accident conditions. The heat removal system is simple, rugged, always operating (being used to remove heat from off-gas sources), and can continue to operate without electric power and unattended to cool the fuel as long as necessary.

In connection with the afterheat removal, it is worth noting that problems associated with it are much less intense in an MSBR because the major source is inseparably associated with a very large mass of salt. (The ratio of heat source at shutdown to heat capacity in the MSBR fuel salt is only about one-tenth of the ratio in the dry core of an LWR.) Because the heat source is so dilute, the "China syndrome" does not appear to be a serious problem in an MSBR.

7.3.3 Status

Advances in the area of reactor technology, in general, and the work in the ANP and MSR programs at ORNL have provided much of the information needed to demonstrate the safety of MSR's. None of the work, to date, has indicated any safety issues that cannot be resolved with existing technology. However, MSR safety technology and the issues that are specific to this reactor concept have not been subjected to the comprehensive analysis and assessment that have been applied to other reactor concepts. Consequently, the safety assurance of MSR's is less firmly founded and some additional technology development is required to demonstrate clearly the safety of these reactor systems. The following paragraphs summarize briefly the current status of MSR safety technology.

7.3.3.1 Accident analysis

From the foregoing background discussion of MSR safety, it is apparent that many postulated accident sequences have been examined for molten-salt systems. In general, these studies have shown that none of the postulated sequences is likely to lead to unacceptable consequences. However, the entire spectrum of accidents has not been examined in sufficient detail to ensure that no high-risk events have been neglected. Nor have the postulated events been thoroughly sorted out from the standpoint of risk. Consequently, further accident analyses are required to define needs and provide guidance for additional safety technology development. The methods and tools required for such analyses are, for the most part, available within the general area of reactor technology. However, it will be necessary to generate comprehensive system models of MSR systems that will allow accurate evaluations of safety-significant events by adequately describing all of the important plant processes, including those which are peculiar to MSR's.

7.3.3.2 Fission product behavior

The general behavior of fission products in molten-salt systems has been largely established by a variety of independent studies and by analyses of the MSRE performance, both during and after its operation. As expected, the noble-gas fission products (xenon and krypton) were readily removed from the circulating fluid and transported to the off-gas system. Although there was significant transport of these materials to the unsealed graphite used in the MSRE, a factor of 6 reduction in xenon poisoning was achieved with a simple gas-stripping system. Once removed, these gases could be effectively and predictably handled in the off-gas treatment facility. Post-shutdown release of gases previously held up on the graphite may, however, be a radiological safety consideration in the primary system of an MSBR.

In the MSRE, at least some of the noble-gas daughters formed in the off-gas system were carried along by the gas stream, and large quantities were accumulated in the particle traps upstream of the charcoal beds. Since the off-gas had no further exposure to the fuel salt, no information was obtained with respect to redissolution in the salt, which could be important in the MSBR drain tank.

The fission products that, from thermodynamic considerations, were expected to remain dissolved in the fuel salt were shown in the MSRE to behave as expected. Among the species of particular interest from a radiological safety standpoint, both iodine and strontium showed no tendency to escape from the salt. Some iodine did appear in the gas in the reactor loop after salt drains, due to decay of precursors that had been deposited on system surfaces. The safety consequences of such releases from an MSBR, both during accidents and during maintenance, must be examined. Many of the noble-metal fission products were found on surfaces in the MSRE. If the apparent sticking coefficient of noble metal atoms to metal surfaces is taken as 1.0, then data from the MSRE

indicate that the apparent sticking coefficient to graphite was 0.5-1.0 and to gas bubbles was <0.1 . It is not clear whether the sticking coefficient to the bubbles was low because the metal particles did not remain on the interfaces as the bubbles circulated in the primary system or because the metal particles, after being released in the pump bowl by the bubbles, were resuspended in the liquid and returned to the primary system. This lack of conclusive data on noble-metal behavior led to the range of distributions projected for the MSBR. Unless data are obtained from other sources to permit better definition of the distribution, the next molten-salt reactor will have to be designed to deal with a substantial range of noble-metal distributions. The principal safety consideration with these materials and their daughters is ensuring that the heat produced by their decay does not adversely affect the integrity of the primary system components on which they are deposited.

The behavior of tritium in molten-salt systems is not yet well understood. Although the control and handling of this material is not a safety consideration per se, the inventory and distribution of tritium must be considered in evaluating the release of radionuclides during accidents. In addition, any accident-related variations in tritium behavior must be well known and protected against.

7.3.3.3 Primary system materials

The area of materials technology for molten-salt reactors is not yet fully developed, as indicated in other portions of this program plan. Much of the safety and safety-related technology of structural materials, graphite, and salts will be developed in conjunction with the efforts in these other areas. From the information that is now available, it does not appear that safety considerations will significantly affect the choices of or the performance requirements on primary system materials. While additional quantitative data on failure limits, failure modes, and interactions under accident conditions will be needed for the detailed evaluation of accident sequences and consequences, the materials that meet the requirements for normal operation and anticipated transients will have suitable safety characteristics.

7.3.3.4 Components and systems

Substantial effort has gone into the development of MSR components, but much more remains to be done, particularly with respect to components on which molten-salt service imposes special requirements (e.g., steam generators and valves). However, as in the case of materials technology, much of the safety and safety-related information will follow from the basic development effort. Among the items of particular interest with regard to safety are the containment and the provisions for afterheat removal.

The ultimate reliance for protection of the public from an MSBR accident rests on the containment system that is in effect during operations.

This system does not involve any untried construction techniques. The inner walls of the reactor cell and the fuel salt drain tank cell must be insulated and the cells must be heated and operated at temperatures above 1000°F. The requirements for this system out to and including the cell liner and liner cooling systems are very similar to those imposed on the internal portions of the PCRV's used for HTGR's. However, because of the lower design pressures involved in MSR containments, it is not expected that prestressing of the concrete vessels (cells) will be required. As pointed out earlier, the characteristics of MSBR fluids impose no severe problem with regard to pressurization or danger of chemical reactions. Therefore, MSBR cells and buildings can be mostly designed and built with the containment technology that has been thoroughly developed for other reactors.

In order to prevent potentially hazardous releases of radioactivity to the environment during routine maintenance, as well as during accident recovery operations, it will be necessary to provide special devices and closed ventilation systems when the containment is opened. Some experience was accumulated along these lines in the operation of the MSRE, but on a much smaller scale than will be involved with the larger MSBR system. This technology will have to be expanded to MSBR scale.

The technology associated with secondary containment is essentially the same as for all other reactor containment systems.

The provision of shutdown cooling in an MSBR has as many facets as there are repositories for the fission products. However, only the cooling of the fuel salt in the drain tank appears to be a significant safety consideration. Preliminary studies indicate that a natural convection cooling system will provide the cooling required for safety.

7.3.3.5 Instrumentation and controls

No detailed studies have yet been performed to define the special needs for safety instrumentation and controls in MSBR's. However, the postulated accidents that have been examined do not appear to impose any requirements beyond those needed for normal, safe operation.

7.3.3.6 Maintenance

The maintenance of molten-salt reactors, even under normal circumstances, promises to be a challenging task. A number of techniques and procedures were developed and demonstrated in the MSRE and some of these will, with further development, be applicable to larger systems. However, additional procedures, such as those for completely semi-remote cutting, cleaning, and welding of large-diameter pipes must be developed for routine maintenance, as well as for recovery from accidents. Preliminary studies have indicated no major differences between the requirements for normal maintenance operations and those associated with major accidents. Similarly,

inspection techniques and procedures that are developed for normal, in-service inspections are expected to be applicable to safety situations. Special safety problems associated with maintenance will be addressed as they are uncovered by the development program.

7.3.3.7 Fuel processing and waste handling and storage

No significant effort has yet been made to identify special safety problems related to these operations in MSR systems. These areas will be addressed as the system technology is developed.

7.4 TASK GROUP 6.1 GUIDANCE STUDIES

7.4.1 Objective

The primary objective of the work in this task group is the performance of detailed analyses of high-risk accidents postulated for MSR systems to: (1) quantitatively define the safety characteristics and safety margins of such systems, and (2) identify any special needs for safety and safety-related technology that must be developed to cause such systems to achieve levels of safety that would permit their application to the generation of electricity on a large scale. A secondary objective is the development of methods, consolidated systems models, and computer programs required for the accurate analysis of significant safety events and sequences.

7.4.2 Schedule and funding

The proposed schedule of effort for the studies to provide guidance for the safety program is shown schematically in Table 7.4.2.1. For the principal tasks, a continuing effort is maintained throughout the program to ensure the availability of current results regarding accident progressions and consequences for safety assessments and the identification of technology needs as they develop. However, the levels of effort, particularly with regard to accident analysis, vary substantially. As shown in Table 7.4.2.2, which shows the proposed funding for this task group, studies to identify and describe accidents and accident sequences rise to higher levels as designs for conceptual and proposed reactor systems are evolved. The effort on transient analyses follows just behind the descriptive analyses but with a similar pattern. Since these studies are contingent on the development of reactor designs, their timing would change with variations in the overall development schedule.

Risk analyses, being heavily dependent on the availability of performance and reliability data for components and systems, cannot be pursued at any substantial level until later in the program. However, some semiquantitative information can be developed with very little input, so a small effort will be undertaken early in the program to provide such guidance as can be derived from these analyses.

Table 7.4.2.1. Schedule for work in Task Group 6.1 - Guidance studies

	Fiscal year												
	1975	1976	1977	1978	1979	1980	1981	1982	1983	1984	1985	1986	
6.1.1 Accident analysis - Ref. design, et al.													
6.1.1.1 Accident description													
6.1.1.2 Accident transient analyses													
6.1.1.3 Risk analysis													
6.1.2 Technology need identification													
6.1.2.1 Safety technology													
6.1.2.2 Safety-related technology													
6.1.3 Analytical methods													

Table 7.4.2.2. Summary of operating fund requirements for Task Group 6.1 - Guidance studies
(costs in 1000 dollars)

	Fiscal year												
	1975	1976	1977	1978	1979	1980	1981	1982	1983	1984	1985	1986	
6.1.1 Accident analysis - Ref. design et al.													
6.1.1.1 Accident description	70	60	30	20	20	60	60	60	60				
6.1.1.2 Accident transient analyses	20	83	90	80	70	60	120	150	245	360	390		
6.1.1.3 Risk analysis			20	40						60	60		
Subtotal 6.1.1	90	143	140	140	90	120	180	210	305	420	450		
6.1.2 Technology need identification													
6.1.2.1 Safety technology		30	20	20	20	30	30	30	40	60	60		
6.1.2.2 Safety-related technology		30	20	20	20	30	30	30	20	30	40		
Subtotal 6.1.2		60	40	40	40	60	60	60	60	90	100		
6.1.3 Analytical methods		30	60	60	60	60	120	120	120	90	100		
Total operating funds for Task Group 6.1	90	233	240	240	190	240	360	390	485	600	650		

The development of analytical methods for safety analyses depends first on the identification of needs which have not been, and are not expected to be, met by efforts within other technology areas. Although such needs are expected to arise, particularly in describing the response of the entire plant to major transients, work on this task will not begin for a few years.

7.4.3 Facilities

The work in this task group is entirely analytical in nature, so no experimental facilities are involved. The large-scale computing capability implied by the transient analysis tasks is expected to be within the range of existing digital, analog, and hybrid facilities currently available at ORNL.

7.4.4 Task 6.1.1 Accident analysis

Several kinds of accident analysis, in increasing levels of detail and accuracy, will be performed to provide a basis for assessing the safety of MSR's. These analyses will be applied initially to the ORNL reference design MSBR to establish, as quantitatively as possible, the safety characteristics of a representative plant. As other conceptual designs are developed, they will be subjected to similar studies to identify any significant variations in safety characteristics or safety margins. The analyses will be made progressively more detailed as the designs are refined, and the most detailed studies will be made on systems actually proposed for construction.

7.4.4.1 Subtask 6.1.1.1 Accident descriptions

The initial effort in the analysis of MSR will be a systematic, qualitative description of possible accidents and event sequences. Although several isolated transients have been examined in some detail and some accident sequences have been proposed and studied, no organized effort has yet been made to identify a major fraction of the possible accidents and the interrelations between them. This effort is expected to result in the identification of a full spectrum of events from minor upsets to accidents with potential major safety significance.

The events will be classified and categorized to determine safety significance based on estimates of the likelihood for occurrence, severity of consequences, and to some extent, availability of defenses against the events. These classifications will be established with the aid of various logical analysis tools, such as event-tree diagrams, which will also help to clarify interactions among events and to identify available and/or needed lines of defense. As additional design information and results of transient analyses become available, the accident descriptions and event-sequence diagrams will be refined to more clearly and quantitatively describe the nature and extent of the safety considerations associated with each accident.

7.4.4.2 Subtask 6.1.1.2 Accident transient analyses

Representative accidents and event sequences identified in Subtask 6.1.1.1 will be subjected to quantitative transient analysis to determine the magnitudes of the consequences of such accidents. The results of these analyses will be used to identify those accidents whose safety significance qualifies them for more detailed analyses. Later results, coupled with the logical analyses, will provide the bases evaluating safety margins as well as for defining additional technology needs and the needs for and performance requirements of engineered safety features.

7.4.4.3 Subtask 6.1.1.3 Risk analysis

The final step in the definition of MSR safety is the performance of risk analyses which entail the appropriate combination of accident occurrence probabilities with accident consequences. Although some qualitative or, at best, semiquantitative analyses of this kind must be carried out early to help select the important accidents, definitive analyses require data concerning component and system performance, reliability, and failure characteristics that will not become available for some time. Thus, studies of this kind, which serve primarily to reduce uncertainties in safety margins, will continue even beyond the operation of prototypical and demonstration reactor systems.

7.4.5 Task 6.1.2 Technology need identification

The accuracy of and, in some cases, even the performance of transient and other accident analyses will be limited by the data that are available to describe material, component, sub-system, and system responses under accident conditions. This task provides for the identification of such needs and their publication so that the necessary information can be developed. Additional technology needs can be expected to occur in all the MSR technology areas, and most of them will be addressed under this task. However, a separate, but complementary, need assessment task is identified in the areas of safety instrumentation and controls (Task Group 6.5) because of the highly specialized and diverse technical requirements of such systems. Since the need assessment task spans the entire range of MSR technology, the work will be shared among a number of people with appropriate technical capabilities.

In general, it is expected that both safety and safety-related technology needs will be identified by this effort, and these categories are addressed by separate subtasks below. It is assumed that needs which are identified and appropriately justified will be fulfilled by efforts in other parts of the overall program.

7.4.5.1 Subtask 6.1.2.1 Safety technology needs

This subtask is concerned with the needs for additional technology associated specifically with the safety of MSR's. That is, it identifies and justifies those needs which could not reasonably be fulfilled by activities in base technology areas. In addition, it will identify needs to check or verify technology developed in other areas to ensure its applicability to safety considerations. As such, it interacts most strongly with other task groups in the area of reactor safety. However, close correlation with base-program activities and need assessments is also required to avoid non-productive duplication of effort.

7.4.5.2 Subtask 6.1.2.2 Safety-related technology needs

This subtask identifies those technology or data developments which, although they are needed for safety studies, are also needed for the design and safe operation of MSR's under more normal conditions. These needs will in most cases have been recognized and be under development as a result of other base-program investigations. However, this effort will help ensure that no important safety-related needs are overlooked.

7.4.6 Task 6.1.3 Analytical methods

This task provides for the development of analytical methods, including computational models, methods, and programs, which are needed for safety analyses and which are not likely to become available from other sources. Since safety analysis deals with transient events which are, by definition, larger than those encountered in routine operation, the analytical tools developed for design and routine analysis may not be adequate for safety work. Among the areas where such inadequacies may occur are comprehensive models to describe the behavior of an entire plant during severe or rapid transients and models to describe large nuclear transients in circulating-fuel reactors. (The "neutronic size" of the core may also be a factor.) Wherever possible, existing models and methods will be adopted or adapted for safety studies. Separate subtasks will be established to meet various development needs.

7.5 TASK GROUP 6.2 FISSION PRODUCT BEHAVIOR

7.5.1 Objective

This task group is concerned with the development of the chemical and physical technology required for accurate description of the behavior of fission products in MSR systems under accident conditions. While many safety and safety-related aspects of fission product behavior will be elucidated by base program studies, the unusual conditions that may arise in some accidents likely will require the initiation of special efforts to obtain data. The work in this task group is directed primarily toward the reactor primary system. Fission product behavior and

Possible releases associated with accidents in the waste storage facilities and the more remote parts of the chemical processing system are treated in Task Group 6.7.

7.5.2 Schedule and funding

Since the investigations of fission product behavior under this task group are contingent upon the identification of safety-specific needs, it is not anticipated that activities will be supported until a substantial amount of safety analysis has been performed. Once the limiting conditions of accidents have been established, it will be practical to review the available technology and the ongoing base program effort to determine what safety needs, if any, remain. Work will then be supported to supply those needs. On this basis no activity is shown on the development of fission-product safety technology for about three years (see Table 7.5.2.1). Subsequently, the effort is expected to proceed at a relatively low level as shown by the funding schedule (Table 7.5.2.2) because essentially all, if not all, of the technology needs are expected to be met by efforts in the base program. The technology development that is supported by the safety program will be carried out by the same staff who are involved in the base program effort.

7.5.3 Facilities

Any technology development that is performed under this task group is currently expected to take the form of extensions in data ranges and investigations of phenomena which are chemically and/or physically similar to studies in the base program. Consequently, it is not anticipated that new or radically different facilities will be required beyond those used in the basic studies. No additional facilities are, therefore, projected.

7.5.4 Task 6.2.1 Fission product release under accident conditions

The release of fission products from the primary system is an important safety consideration in MSR accidents. The processes involved must also be considered for normal operation and, particularly, when the primary system is opened for maintenance. However, it is conceivable that conditions during accidents may sufficiently alter these processes so as to require additional study. Some of the mechanisms that may be investigated, subject to establishment of need, are discussed in the following subtasks.

7.5.4.1 Subtask 6.2.1.1 Fission product release from salts

The release characteristics of fission products from fuel salts have been studied extensively and the normal behavior is moderately well known. Additionally, information will be developed within the base program for normal and near-normal conditions. This subtask provides for investigations under special conditions that might result if, for example, the

Table 7.5.2.1. Schedule for work in Task Group 6.2 - Fission product behavior

	Fiscal year									
	1975	1976	1977	1978	1979	1980	1981	1982	1983	1984
6.2.1 Fission product release under accident conditions										
6.2.1.1 FP release from salts										
6.2.1.2 FP release from metal surfaces										
6.2.1.3 FP release from graphite										
6.2.1.4 FP release from failed charcoal bed										
6.2.2 Tritium release under accident conditions										
6.2.3 Fission product behavior in primary and secondary containment										

Table 7.5.2.2. Operating fund requirements for Task Group 6.2 – Fission product behavior
(costs in 1000 dollars)

	Fiscal year									
	1975	1976	1977	1978	1979	1980	1981	1982	1983	
6.2.1 Fission product release under accident conditions										
6.2.1.1 FP release from salts				15	30					
6.2.1.2 FP release from metal surfaces					15	15				
6.2.1.3 FP release from graphite				15						
6.2.1.4 FP release from failed charcoal bed						30				
Subtotal 6.2.1				30	45	45				
6.2.2 Tritium release under accident conditions						15	30			
6.2.3 Fission product behavior in primary and secondary containment							15	45		
Total operating funds for Task Group 6.2				30	45	60	45	45		

primary system were breached and salt were spilled and dispersed in the primary containment.

7.5.4.2 Subtask 6.2.1.2 Fission product release from metal surfaces

Fission product releases from MSR metal surfaces, both with and without salt present, has received some attention but more studies are required in the base program. This process is particularly important for maintenance operations because deposited tellurium can be a source of free iodine. From the standpoint of safety, releases from overheated surfaces or when the containment atmosphere is less well controlled than for normal maintenance may require special investigation.

7.5.4.3 Subtask 6.2.1.3 Fission product release from graphite

Fission products trapped in and on graphite may be subject to different release processes when the graphite is strongly heated or exposed to contaminants during accidents. If such processes are shown to have the potential for altering the safety characteristics of MSR systems, they will be investigated and evaluated.

7.5.4.4 Subtask 6.2.1.4 Fission product release from failed charcoal beds

Although the charcoal absorber beds for retention of noble-gas fission products are not an integral part of the reactor primary system, they are sufficiently closely coupled to it that failure could lead to a release of fission products into the primary containment. The high fission-product inventory of these beds makes it desirable to examine their potential effect on safety. Release processes that are peculiar to reactor accident conditions would have to be defined before studies are initiated.

7.5.5 Task 6.2.2 Tritium release under accident conditions

Depending upon the nature of the tritium retention and control processes that are developed for MSR's, either or both the primary and secondary systems may contain substantial quantities of this radionuclide. It is considered separately here because its behavior mechanisms differ significantly from those of other fission-product radionuclides and because the tritium handling technology for MSR's is a separate problem. Until the tritium technology is developed further it will not be practical to identify any specific investigations into safety problems in this task. However, such studies will be carried out when, and if, needs are identified.

7.5.6 Task 6.2.3 Fission-product behavior in primary and secondary containments

The safety technology of fission-product behavior within containments has been extensively studied in connection with other reactor types, and applicable portions of that technology will be used in MSR safety studies. However, the fundamental differences between MSR's and other reactors could lead to different chemical and physical forms and mixtures of fission products in the containment after an accident. Studies should be performed to determine whether such differences occur and if they significantly affect (either favorably or unfavorably) the in-containment behavior of the radionuclides. If differences are found, their impact on reactor safety should be evaluated.

7.6 TASK GROUP 6.3 PRIMARY-SYSTEM MATERIALS

7.6.1 Objective

The interactions, responses, and failure modes of primary-system materials under accident conditions must be known if detailed safety analysis are to be carried out. The objective of the work in this task group is the quantitative establishment of any such safety-significant processes and properties that are not established in base-program investigations.

7.6.2 Schedule and funding

The investigation of material properties and interaction processes requires first that the parameter ranges that are peculiar to safety be identified by extensive analysis of accidents and event sequences. Consequently the schedule for this task group (Table 7.6.2.1) shows no activity for three to four years. The schedule beyond that point is also somewhat vague because of the strong possibility that most of the required safety technology will probably be developed by minor extensions of established base technology tasks. The funding (Table 7.6.2.2) is projected at a low level for the same reason.

7.6.3 Facilities

As is the case in the other safety-technology task groups, no special facility needs are projected because the same facilities used for the related base program effort are presumed to be usable and available for this work.

7.6.4 Task 6.3.1 Materials compatibility under accident conditions

The effects and consequences of primary system material interactions will be extensively investigated in establishing the technology required for the design, construction, and normal operation of MSR systems. Abnormal

Table 7.6.2.1. Schedule for work in Task Group 6.3 - Primary system materials

	Fiscal year								
	1975	1976	1977	1978	1979	1980	1981	1982	1983
6.3.1 Materials compatibility under accident conditions									
6.3.1.1 Primary-to-secondary salt				-----	-----				
6.3.1.2 Salt to graphite				-----	-----				
6.3.1.3 Salt to metal					-----	-----			
6.3.1.4 Salt to drain-tank coolant						-----	-----	-----	
6.3.2 Metal failure modes and properties				-----	-----				
6.3.3 Graphite failure modes and properties					-----	-----	-----	-----	
6.3.4 Salt behavior at extreme conditions			-----	-----					

Table 7.6.2.2. Operating fund requirements for task group 6.3 - Primary system materials

	Fiscal year							
	1975	1976	1977	1978	1979	1980	1981	1982
6.3.1 Materials compatibility under accident conditions								
6.3.1.1 Primary-to-secondary salt				20	10			
6.3.1.2 Salt to graphite				20	20			
6.3.1.3 Salt to metal					10	30		
6.3.1.4 Salt to drain-tank coolant						20	30	
Subtotal 6.3.1				40	40	50	30	
6.3.2 Metal failure modes and properties				30	20			
6.3.3 Graphite failure modes and properites					10	50		
6.3.4 Salt behavior at extreme conditions			30	20				
Total operating funds for Task Group 6.3			30	90	70	100	30	

or unusual interactions that may be associated with accidents will be investigated in this task. Some of the areas in which such investigations may be carried out, subject to need identification, are discussed in the following four subtasks.

7.6.4.1 Subtask 6.3.1.1 Primary-to-secondary salt compatibility

This subtask will investigate primarily any unusual effects associated with mixing of fuel and coolant salts in amounts and at rates which are much greater than would ordinarily be anticipated. At the more severe conditions (still to be defined) experienced in accidents, dynamic or transient phenomena may have an effect on safety consequences and these will be examined. The studies will be confined to salt mixtures whose use in MSR's is rather firmly established.

7.6.4.2 Subtask 6.3.1.2 Salt-graphite compatibility

Possible unusual interactions between salts and graphite under accident conditions will be examined to determine their safety consequences, if any. Among the phenomena to be considered, subject to establishment of need, are salt boiling near graphite and effects of vapors produced by such boiling. Additional processes may be identified by accident analyses.

7.6.4.3 Subtask 6.3.1.3 Salt-metal compatibility

Interactions between salts, or salt vapors, and primary-system metals under accident conditions, such as very high temperatures, will be investigated and evaluated for possible safety consequences. Only those conditions will be considered that are not addressed in base-program studies.

7.6.4.4 Subtask 6.3.1.4 Salt compatibility with drain tank coolant

No processes or mechanisms can be currently identified that would not be evaluated for normal operation and anticipatable transient conditions. If processes with potential safety significance are suggested by accident analyses, they will be studied.

7.6.5 Task 6.3.2 Metal properties and failure modes

This task provides for investigations of metal properties in parameter ranges that may be associated with accidents, but which would not otherwise be required. Of particular interest are properties, behavior, and failure modes of metals exposed to very high temperatures because of their potential effects on the consequences of long-term loss of cooling situations.

7.6.6 Task 6.3.3 Graphite properties and failure modes

Graphite characteristics and possible failure modes under extreme conditions of thermal cycling or thermal shock should be examined for possible effects on reactor safety. Probably the most significant safety consideration is that some degree of structural integrity be maintained in the graphite moderator, but the integrity requirements have not been determined. Since MSR graphite temperatures in severe accidents are at least somewhat similar to those calculated for HTGR's, it may be possible to make use of some aspects of graphite safety technology from HTGR studies.

7.6.7 Task 6.3.4 Salt behavior at extreme conditions

Some consideration should be given to the safety aspects of salt behavior at extreme temperatures or in the presence of contaminants that may be introduced by accidents. Vapor and liquid compositions that result from boiling, as well as possible solid-phase separations, would be examined if accident studies showed potential safety effect.

7.7 TASK GROUP 6.4 COMPONENT AND SYSTEMS TECHNOLOGY

7.7.1 Objectives

This task group is devoted to the investigation of safety significant processes, including failure, that may affect major components and systems in an MSR plant. The primary concern is with major safety systems, such as containment, and highly abnormal processes, such as seismic events, but other components, systems, and processes may be considered if safety needs are identified. The objective of this work is to develop those aspects of the relevant technologies that will help to define and evaluate the safety consequences of accidents.

7.7.2 Schedule and funding

Development of component and system technology requires that the conditions and performance requirements likely to be imposed on those systems by postulated accidents be clearly defined by accident analyses. Such analyses, in turn, require that reasonably detailed reactor-system conceptual designs be available. Consequently, the major effort under this task group, as shown in Table 7.7.2.1, begins after the development of the needed design information. Some of the more readily apparent needs can be identified from studies of current conceptual designs, so a small amount of work can be started earlier. Table 7.7.2.2 shows the estimated level of effort required for studies of currently recognized safety questions. Since these studies are strongly dependent on the degree of technology development under base programs, the amounts tend to be somewhat speculative.

Table 7.7.2.1. Schedule for work in Task Group 6.4 -- Component and systems technology
(accident conditions)

	Fiscal year											
	1975	1976	1977	1978	1979	1980	1981	1982	1983	1984	1985	1986
6.4.1 Containment systems												
6.4.1.1 Effects of salt spills -- short term												
6.4.1.2 Long-term effects of salt-spill residues												
6.4.2 Seismic and vibration technology												
6.4.2.1 Failures of primary-system components												
6.4.2.2 Failures of engineered safety features												

Table 7.7.2.2. Operating fund requirements for Task Group 6.4 - Component and systems technology-accident conditions (costs in 1000 dollars)

	Fiscal year											
	1975	1976	1977	1978	1979	1980	1981	1982	1983	1984	1985	1986
6.4.1 Containment systems												
6.4.1.1 Effects of salt spills - short term						30	30					
6.4.1.2 Long-term effects of salt-spill residues						30	20					
Subtotal 6.4.1						60	50					
6.4.2 Seismic and vibration technology												
6.4.2.1 Failures of primary-system components						60	60	80	105	125	125	
6.4.2.2 Failures of engineered safety features							50	85	105	125	125	
Subtotal 6.4.2						60	110	165	210	250	250	
Total operating funds for Task Group 6.4						120	160	165	210	250	250	

7.7.3 Facilities

Major facilities will be required for development of the base technology for MSR components and systems (see Section 10) and it is expected that those facilities will be suitable and available for studies of safety technology. One possible exception to this situation is in the area of seismic studies. If the guidance studies reveal a need for a seismic program that is specific to MSR's, and not satisfied by other seismic study efforts, special seismic facilities might be required. Since no special needs are currently recognized or anticipated, no facilities are projected for the work in this task group.

7.7.4 Task 6.4.1 Containment systems

Because the materials to be contained as a consequence of MSR accidents may differ from the materials of interest in other reactor systems, some safety studies of MSR containments should be made. These studies would be expected to delineate any unique requirements for or properties of these containments. The following four subtasks describe possible areas of investigation.

7.7.4.1 Subtask 6.4.1.1 Effects of salt spills-short term

Spills of primary and/or secondary salt into the primary containment represent one class of possible consequences of MSR accidents. Since the inside of the containment boundary may be covered by thermal insulation and, presumably, an inner liner,* the possible effects of such spills on the containment integrity and heat-removal capability should be examined. Only short-term exposures need to be considered, however, because all salt spills flow to the fuel drain tank.

7.7.4.2 Subtask 6.4.1.2 Long-term effects of salt-spill residues

Major salt spills, if they occur, are almost certain to leave some salt residues in the primary containment. The degree to which such residues are removed is probably determined by requirements for opening the containment to perform maintenance. However, if residues are acceptable from all other standpoints, it should be shown that they will have no long term deleterious effect on the containment safety characteristics. This subtask provides for the investigation of any such potentially harmful effects.

* This arrangement would be rather similar to that on the inside of a PCRV for an HTGR.

7.7.4.3 Subtask 6.4.1.3 Effects of other impurities

In addition to salt, the primary containment of an MSR could conceivably be exposed to other impurities as a consequence of an accident. Among the materials to be considered are air, drain-tank cooling fluid, and water from the containment cooling system. The credibility of such introductions must be considered, but the potential consequences of introducing the contaminants helps to determine the importance of excluding specific materials. Thus, some study of the safety effects of other contaminants is proposed.

7.7.5 Task 6.4.2 Seismic technology

Seismic events, at least up to the magnitude that may be used as a safe-shutdown earthquake (SSE), should be examined in MSR safety studies, partly to determine the responses of components and systems to such events and partly to help define the safety requirements of plant designs to survive the SSE without unacceptable consequences. Although methods for analyzing and evaluating seismic events are reasonably well established, additional work may be required to permit analysis of the different components and systems associated with MSR's. This task provides for any special development of seismic analysis capability that is needed.

7.7.5.1 Subtask 6.4.2.1 Failure of primary-system components

The ability of existing techniques to analyze response and describe failure modes of MSR components under seismic stress will be examined under this subtask. Any required capabilities that are peculiar to MSR's would be developed and verified for use in accident analyses.

7.7.5.2 Subtask 6.4.2.2 Failure of engineered safety features

The same types of studies identified in Subtask 6.4.2.1 would also be applied to the engineered safety features developed or specified for molten-salt reactors. These efforts are assigned to a separate subtask because of their importance to the overall safety of the plant.

7.7.6 Other safety technology tasks

Although no other needs for safety technology associated with components and systems are currently identified, it is considered likely that such needs will arise as the general technology of MSR's evolves. Therefore, it is anticipated that other tasks may, in the future, be added to this group.

7.8 TASK GROUP 6.5 SAFETY INSTRUMENTATION AND CONTROLS

7.8.1 Objective

Preliminary studies of the needs for safety instrumentation and controls for MSR's have revealed no major unusual requirements. Some consideration must be given to the fact that the devices will be required to perform at high ambient temperatures, but this is a normal operational as well as a safety requirement. Nevertheless, it seems prudent to examine carefully the safety instrumentation and controls needs as reactor designs are developed and general safety needs are defined to ensure that any unique safety requirements are recognized and resolved.

7.8.2 Schedule and funding

The review of safety instrumentation and controls needs should be based on a reasonably well established conceptual plant design. Therefore, no effort is projected for the first several years of the program. However, it is presumed that instrumentation and controls work in this task group will be carried out during the period FY 1981 through FY 1985, and operating funds in the amount of \$50,000 will be required in each of these years. It is also possible that work would be required after this period. Development to meet normal operational needs will proceed (see Section 12) and if that work were to suggest a need for earlier safety studies, they would be instituted as required. Since no special safety needs are anticipated, the funding projected for this task group provides only for surveillance of related activities and identification of possible needs. If actual safety needs were identified, additional funding would be required to support the associated development effort.

7.8.3 Facilities

No facility needs beyond those required for instrumentation and controls development within the base program are anticipated.

7.8.4 Task 6.5.1 Identification of instrumentation and controls safety needs

This task provides for a review of safety instrumentation and control requirements for MSR's under accident conditions and the identification of any needs which have not been and are not likely to be met within the base-program development effort. Also provided for is a review of the existing technology for other reactor concepts to determine which needs, if any, can be met by products of other development programs.

7.8.5 Technology development tasks

Tasks to develop instrumentation and controls safety technology will be added to this program plan when, and if, needs for such development are identified and justified. The nature of those tasks is dependent on the results of Task 6.5.1.

7.9 TASK GROUP 6.6 MAINTENANCE TECHNOLOGY

7.9.1 Objectives

The primary effort to develop the maintenance technology for MSR's is described in Section 11. Since the technology that is developed for normal maintenance must be able to cope with high levels of radioactivity throughout the reactor primary system, it is believed that some aspects of this technology can be adopted or adapted to help mitigate accident consequences and to recover from accidents. Among the situations in which maintenance procedures could benefit reactor safety are those where the secondary containment remains accessible and work must be done to restore vital services, such as afterheat removal capability. The objective of the work in this task group is to identify ways in which maintenance technology could contribute to reactor safety and to develop systems and procedures that are shown to be useful.

7.9.2 Schedule and funding

Application of MSR maintenance technology to safety situations will require substantially greater development of the methods and tools than is now available. In addition, detailed studies are required of situations in which maintenance activities might be used to enhance safety. Consequently, this work is considered to be a relatively long-range effort which would proceed roughly in parallel with the design and construction of reactor facilities. No work is projected before 1982, and subsequent work is contingent on the success of the initial effort. The funding for this work would begin at a low level and gradually increase to levels indicated by then-established needs. It is currently planned that work will be carried out during FY 1982 through FY 1985, and \$50,000 in operating funds will be required in each of these years.

7.9.3 Facilities

Since it is presumed that the work in this task group would proceed along lines generally consistent with normal maintenance technology, the facilities established for development of that normal technology would be used. No special facilities are, therefore, projected for the safety effort.

7.9.4 Task 6.6.1 Development of maintenance technology to enhance safety

This task, and others in this task group which may subsequently be defined, will develop special maintenance techniques, procedures, and equipment, consistent with the normal maintenance technology, to help mitigate the consequences of major postulated accidents and to assist in the recovery from such accidents. Specific technology to be developed is contingent on the definition and justification of safety needs.

7.10 TASK GROUP 6.7 SAFETY TECHNOLOGY OF PROCESSING AND WASTE STORAGE AND HANDLING

7.10.1 Objective

Since an MSR plant incorporates its own fuel processing and intermediate-term waste storage facilities, the safety technology associated with these facilities must be addressed as part of the overall safety effort. (Safety significant events in these ancillary facilities probably will not directly affect reactor safety, and vice versa, but some safety-related interdependence may be involved.) The purpose of the work in this task group is to develop any needed safety technology to minimize the possibility of major accidents in these facilities and to help mitigate the consequences of accidents which might occur.

7.10.2 Schedule and funding

Postulated accidents involving the fuel processing and waste facilities will be examined as part of the safety guidance effort, Task Group 6.1. Results of that effort, along with the onset of design and construction of facilities for a reactor will determine the schedule for this work. However, no significant effort is anticipated prior to 1982. It is planned that work will be carried out during FY 1982 and FY 1983, and \$50,000 in operating funds will be required during each of these years. The schedule and funding beyond this period depends on the nature of the safety needs that are identified. The initial funding for this work is at a low level to permit planning of the safety development work required to meet the needs. Additional funding would be provided as needed to carry out specific developments.

7.10.3 Facilities

No facility needs can currently be projected for this work.

REFERENCES FOR SECTION 7

1. Roy C. Robertson, editor, *Conceptual Design Study of a Single-Fluid Molten-Salt Breeder Reactor*, ORNL-4541 (June 1971).
2. Title 10, Code of Federal Regulations, Part 100, Paragraph 100.11.
3. R. E. Thoma, *Chemical Aspects of MSRE Operation*, ORNL-4658 (December 1971).

8. REACTOR DESIGN AND ANALYSIS

8.1 INTRODUCTION

8.1.1 Objective

The objectives of this activity are: (1) to develop the conceptual design for a commercial 1000-MW(e) MSBR in sufficient detail to identify the major areas in which additional technology development is required and to produce meaningful estimates of the nuclear and economic performances of this reactor type, (2) to develop the design criteria and conceptual design for a molten-salt demonstration reactor that will provide the information necessary for construction of commercial MSBR's in sufficient detail to identify additional technology development which is required for construction of the demonstration reactor and to provide improved estimates of the capital and operating costs for the demonstration reactor, (3) to develop the design criteria and conceptual design for a molten-salt test reactor in sufficient detail to identify additional technology development which is required for construction of the test reactor and to provide improved estimates of the capital and operating costs for the test reactor, and (4) to develop the design criteria and conceptual design for a molten-salt test reactor mockup in sufficient detail to identify additional technology development which is required for construction of the test reactor mockup and to provide improved estimates of the capital and operating costs for the mockup.

An additional important objective of this activity is the examination of alternate reactor types such as molten-salt converter reactors using uranium or plutonium fuel makeup as well as uses for molten-salt reactors other than large central station electric power generation in sufficient detail to assess the likely economic importance of alternate molten-salt reactor types. Limited conceptual design work would be carried out on alternate reactor types which show promise.

8.1.2 Scope

The scope of this activity consists of the general areas of (1) design studies for MSR power plants, (2) systematic accumulation of design information, (3) identification and development of codes and standards, (4) examination of factors important in licensing MSR's, and (5) development of computational methods for nuclear analysis of MSR systems and their application.

8.1.2.1 Task Group 7.1 Design studies of MSR power plants

The scope of this task group includes completing conceptual designs for a commercial 1000-MW(e) MSBR as well as for a demonstration reactor, a test reactor, and a test reactor mockup in sufficient detail to identify and guide the required technology development and to provide meaningful

cost and schedule projections. The intent of the design work is for program guidance only, and no systems will be designed in sufficient detail for component fabrication. Limited studies and conceptual design will be carried out for MSR types other than high performance breeders in order to assess their likely economic impact.

8.1.2.2 Task Group 7.2 Design technology

The scope of this task group includes the areas of establishing design bases and methods for equipment for 1300°F operation; the compilation of design properties for fuel and coolant salts, graphite, Hastelloy N, and other reactor materials; the preparation of design reports on selected MSR systems; the compilation of cost data and analysis of plant costs for MSR systems; and the operation of a comprehensive molten-salt reactor information system.

8.1.2.3 Task Group 7.3 Codes and standards

The scope of this task group includes the identification and development of the necessary codes and standards for design and construction of MSR plants and component development facilities. Existing codes and standards such as ASME Boiler and Pressure Vessel Code Section 3, Class 1, as well as RDT standards and quality assurance procedures, will be carefully examined with respect to MSR systems, and additional codes and standards will be developed as necessary to ensure that satisfactory design, construction, installation, and testing procedures are available.

Code cases required for use of materials in nuclear service, such as the use of modified Hastelloy N in the MSBR primary circuit, will be developed and submitted as necessary.

8.1.2.4 Task Group 7.4 Licensing of MSR's

The scope of this task group includes those activities required to identify any characteristic of molten-salt reactors which could adversely affect obtaining a license for operation and to develop acceptable alternatives to mitigate serious delay. In particular, it is intended that sufficient attention be given to this area that questions affecting licensing can be identified early and suitable alternatives developed before significant investments are made in technology development and conceptual design.

8.1.2.5 Task Group 7.5 Nuclear analysis of MSR power plants

The scope of this task group includes the nuclear analysis of control systems and methods, and the development of additional computer methods as required for analyzing the nuclear performance of MSR systems under both steady-state and anticipated transient conditions.

8.2 PROGRAM BUDGET AND SCHEDULE

8.2.1 Schedule

The design studies will concern several different reactors and there will be overlapping in time, as certain work on different concepts will be carried on simultaneously. The studies having to do with the 1000-MW(e) MSBR, as an example, will be a continuing study. The reference design reported in ORNL-4541 will be used as a point of departure for these studies. Nuclear calculations and cost analyses will be updated as the supporting technology development progresses. Figure 8.2.1 shows diagrammatically how the major reactor design efforts are interrelated and the involvement of industrial participants in the work. Also shown, to add perspective, is part of the reactor technology development effort (discussed in detail in Section 10) leading to the construction and operation of a Components Test Facility (CTF) which will provide important input to the reactor design work.

The studies on conceptual designs of commercial plants will guide development work and will indicate areas in which further work is required. Initial work on the 1000-MW(e) plant will deal primarily with safety. During FY 1975, safety studies (see Section 7) will occupy most of the design analysis work. Beginning in FY 1976, performance and economic analyses will be started at a low level. Beginning in FY 1977, some conceptual design work will be started on the 1000-MW(e) breeder. This effort will be directed toward several features of the reference design that are known to require additional study.

The schedule chart, Table 8.2.1, shows three large projects leading to the commercial breeder: a molten-salt test reactor (MSTR), an MSTR mockup, and a demonstration reactor. These will be started in a staggered way as shown. After a serious review has been made of the MSBR studies that have taken place in the past, a start will be made on determining the preliminary design of the demonstration plant.

Factors related to the 1000-MW(e) MSBR which require further study include heat exchanger design, core design, moderator graphite removal, and the drain tank cooling system. It is anticipated that by the beginning of FY 1977, any remaining questions regarding the choice of a secondary coolant will have been resolved. This is a rather urgent question that must be answered as soon as possible as it influences much of the design of the plant. All aspects of safety including licensability will be studied thoroughly beginning during FY 1975.

Preliminary conceptual design of the demonstration plant will begin in early FY 1978. Basic questions such as the number of primary loops, type of heat exchanger, and maintenance philosophy (removal of heat exchangers versus tube plugging) will be considered. The number of primary loops will tend to determine the size of the components to be tested in the reactor mockup. Conceptual design of the demo plant will continue throughout the period covered by this activity as desirable changes in design become apparent from the technology development studies.

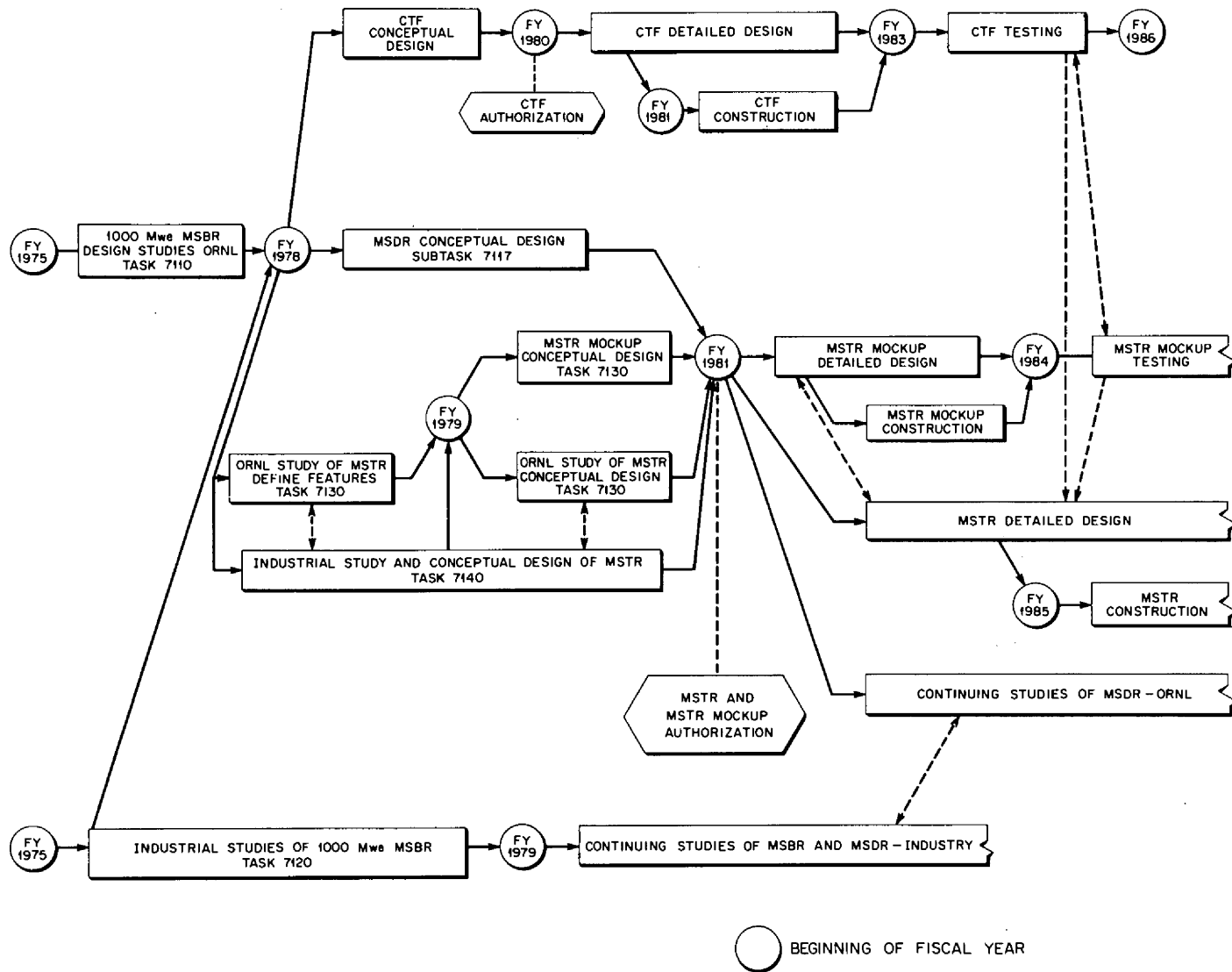

Fig. 8.2.1. Diagrammatic representation of design and design-related development activities.

Table 8.2.1. Schedule for work on reactor design and analysis

	Fiscal year											
	1975	1976	1977	1978	1979	1980	1981	1982	1983	1984	1985	1986
7.1 Design studies of MSR power plants												
7.2 Design technology												
7.3 Codes and standards												
7.4 Licensing of MSR's												
7.5 Nuclear analysis of MSR power plants												

A test reactor, intended to prove the features of the demonstration reactor, will be operated prior to completion of the demonstration plant design. Conceptual design of the test reactor will begin in FY 1978. This timing allows two years of conceptual design to have been completed on the larger plants in order to establish the basic elements of the test reactor.

Also by FY 1978, enough of the design technology will have been completed that high temperature design bases will have been determined so that the conceptual design will be on reasonably firm ground. After two years, by the end of FY 1979, the preliminary safety and hazard analyses will have been completed so that authorization for the test reactor can be requested. The period FY 1981 through FY 1984, will be required to complete enough of the detailed design of the test reactor plant so that construction can begin in early FY 1985.

When design of the test reactor plant has been largely completed, work can be concentrated on the design of the chemical processing plant which is scheduled for completion by mid FY 1986. The entire test reactor plant should be completed by the beginning of FY 1989, and operation of the system can begin.

The fourth major design effort will be concerned with a reactor mockup. In order to have the input from the other conceptual design studies, design of the mockup will not begin until the start of FY 1979. All major decisions about design temperatures, salt compositions and component configurations will have been reached by this time. Also, code cases will be in preparation so that the necessary technology to do the design will be in hand. Authorization for the reactor mockup is to be requested for the beginning of FY 1981 with completion of a major portion of the detailed design by FY 1982.

Construction of the reactor mockup will begin in FY 1982 and will be completed two years later. The design of the chemical processing system will not be completed until about mid FY 1984, with construction of the system to follow, aiming at a total reactor mockup completion date of the end of FY 1985. The plant will then be operated as long as useful information can be obtained from it. It is likely that, toward the end of operation, some rather drastic off-design-point experiments will be run. These tests might involve thermal shock, or similar kinds of experiments which would yield valuable information.

The activities shown in Table 8.2.1 include substantial participation by industry during the first few years, via work subcontracted by ORNL and possibly by work supported by industry. (It is anticipated that subsequent industrial activity would be associated primarily with the large capital projects.) The primary purposes of this participation are to further develop industrial interest and to allow the program to benefit from industrial views and concerns while conceptual designs are evolving. It is expected that the final conceptual designs of both the

MSTR and the demonstration reactor would be developed as a joint ORNL-industry effort. In addition, industrial reviews and evaluations will be extremely valuable in guiding the overall technology development effort.

Mainly for comparison purposes, there are some other studies which will parallel the continuing 1000-MW(e) studies. These will involve chiefly nuclear and economic analyses of converter reactors and plutonium-fueled MSR's. Some conceptual designs will likely be made to see where capital costs can be reduced by the more simple plants. These studies will be worked in as they are needed.

8.2.2 Budget

A summary of the funding projected for this activity area is shown in Table 8.2.2, with separation of the ORNL and ORNL-subcontracted industrial components. The industrial effort covers (1) early participation by industry in helping to define the conceptual design of the 1000-Mw(e) MSBR, and a test and demonstration reactor and (2) industrial assistance on the design and construction of large component test and development facilities. The low level of support for the ORNL effort during the first two years reflects the fact that no conceptual design work is projected; only performance and safety assessment of the reference design is planned. The ORNL design effort would increase with the onset of conceptual design work in FY 1977 and reach a peak during FY 1979 as the conceptual designs of the MSTR and the MSTR mockup are completed. The required funding would then decline somewhat; however, significant support would be required for more detailed conceptual design studies of the demonstration plant, and especially for continuing work on MSR licensing and the development of codes and standards.

8.2.3 Key program milestones

The completion of certain parts of the design and analysis effort of MSR's will represent milestones of the program. The first of these, expected to come in about two years (FY 1977), is a firming up of the design technology to the point where materials and design bases for their use at high temperatures can be considered to be established. This should permit the second milestone, a commitment in early FY 1981 to build a test reactor.

A reactor mockup is to be built and operated prior to the construction and operation of the MSTR, and the authorization of the mockup is coincident with authorization of the test reactor. Other significant milestones that relate to design and analysis are the completion of the MSTR mockup in FY 1984, and the start of MSTR construction in FY 1985.

Table 8.2.2. Operating fund requirements for reactor design and analysis
(cost in 1000 dollars)

	Fiscal year											
	1975	1976	1977	1978	1979	1980	1981	1982	1983	1984	1985	1986
7.1 Design studies of MSR power plants	60 (200) ^a	210 (500)	170 (300)	177	203	393	400	415	395	275	225	
7.2 Design technology	50	157	230	172	141	95	75	75	75	75	75	
7.3 Codes and standards			35	64	128	192	200	130	130	200	200	
7.4 Licensing of MSR's				32	128	192	250	200	200	200	200	
7.5 Nuclear analysis of MSR power plants	12	100	95	95	95	128	75	30				
Total reactor design and analysis operating funds	122 (200)	467 (500)	530 (300)	540	695	1000	1000	850	800	750	700	

^aFigures in parentheses represent industrial participation and are totaled separately.

8.3 BACKGROUND AND STATUS

A comprehensive summary of the background and status of the molten-salt reactor was issued in August 1972;¹ and since the program was interrupted soon after the report was issued, the information contained in it is still reasonably current.

Over the past twenty years, several molten-salt reactor plants have been examined conceptually, and two experimental molten-salt reactors were built and operated at ORNL. The Aircraft Reactor Experiment was operated briefly in 1954 (ref. 2) and demonstrated the basic concept. However, since the mission of that project was not central-station power generation, the reactor lacked many features that are important for large-scale breeders. In the middle 1960's another molten-salt reactor, the MSRE, was operated for an extended period of time and yielded much valuable data upon which power reactor concepts could be based. This system used a fuel salt generally similar to that proposed for the breeder, an unclad-graphite moderator, a secondary coolant salt circuit, and a structural alloy of interest to the breeder concept.

Two basic breeder concepts have been studied and reports have been issued on the conceptual design studies.^{3,4} The first of these involved two radioactive primary coolants, a fissile stream of uranium, lithium, and beryllium fluorides and a completely separate blanket or fertile salt of thorium, lithium, and beryllium fluorides. This system appeared to offer excellent breeding performance and a relatively simple fuel processing plant, but maintaining the separation of the two fluids via graphite tubes in the core would have been difficult in view of the dimensional changes which occur in graphite during neutron irradiation. Developments in the area of chemical processing and recognition of alternate neutronic design possibilities led to the adoption of a single-fluid concept in which both the fissile and fertile materials are dissolved in one primary salt.

For the past several years, the MSR conceptual design effort has been directed toward the single-fluid breeder system which features a single, large reactor vessel and four primary coolant pumps that circulate fuel salt between intermediate heat exchangers and the core. The reactor vessel contains unclad graphite to provide neutron moderation and three "zones:" core, blanket, and reflector. Fuel salt circulates through all three zones which are not physically isolated from each other; the different neutronic effects in the zones are achieved by carefully selecting the fuel-to-moderator ratio for each zone. Each primary loop contains equipment for gas (helium) injection and removal to provide for stripping of ^{135}Xe and other volatile species. Some fuel salt is continually circulated between the drain tank and the primary loops to cool portions of major components and the off-gas stream. The drain tank provides the initial holdup for decay of fission-product gases as well as afterheat removal capability if the fuel salt must be drained from the primary loop.

Beyond the primary system, there are no major differences between the one-fluid and the older, two-fluid concepts. A secondary salt, currently sodium fluoroborate, transports the fission energy from each intermediate heat exchanger to a steam generator which is coupled to a more-or-less conventional supercritical steam system for generation of electricity.

All parts of the primary system are contained in metal-lined, hermetically sealed cells which provide primary containment and radiation shielding. Secondary containment is provided by the usual domed cylindrical structure which encloses the reactor plant.

8.3.1 Primary systems layout and structural design

Although the basic reactor concept is reasonably well established, there are many aspects that have not yet been studied in sufficient detail to resolve all potential questions. These include the layout and design of all major parts of the primary system.

Since the primary coolant in an MSBR contains the fissile material, both the breeding performance (doubling time) and the economic performance are influenced by the out-of-reactor inventory of fuel salt (i.e., that in the drain tank, pumps, piping, heat exchangers, and processing plant). Thus, there is considerable incentive to make the primary system as compact as possible, consistent with the design requirements of adequate heat transport, long life, maintainability, and safety and reliability during both steady-state and transient conditions. While all of these requirements were considered in the evolution of the conceptual design and layout (from which inventory, performance, and cost data were developed), the required detailed reviews and analyses have not been performed to fully prove the designs.* In particular, more stress analysis work is required to show that ordinary mechanical, as well as thermal, stresses throughout the system are compatible with design and life requirements for all conditions.

The physical arrangement of the graphite inside the reactor vessel of an MSBR is important in determining the performance of the system. In the "core" and "blanket" zones, the fuel (or graphite) volume fraction affects breeding performance, as well as the basic neutronic character, of the plant and must, therefore, be carefully established and maintained during all phases of operation. The reflector must be cooled by flowing fuel salt, but the fuel volume fraction must remain low in the outer regions to prevent high fission rates in these regions which would lead to increased neutron losses (lower breeding gain) and greater irradiation damage to the reactor vessel. Since graphite dimensional changes are an

* Substantial review and analysis work along these, and other, lines was carried out by the Molten-Salt Group under the direction of Ebasco Services, Inc., through a subcontract with ORNL. The results are recorded in internal correspondence.

effect of neutron irradiation, the core must be designed to accommodate such changes without unacceptably degrading the reactor performance. The power densities and attendant fast-neutron fluxes in the high-power regions will limit the useful life of present-technology graphite to about four full-power years. Therefore, the graphite arrangement must also allow for periodic replacement of at least some of the moderator. Additional work is required to resolve remaining design questions related to the graphite configuration and the removal and replacement of graphite in the core region.

Additional work is required to ensure that radiation heating is appropriately handled in the reference design. During operation, sufficient salt or other coolant flow must be available to remove direct radiation heat from all components; heat rejection from components must also be adequate to prevent overheating due to the decay of deposited fission products when no salt is present (as after a drain); the drain tank cooling system must safely accommodate all normal and credible abnormal heat removal situations. All of these considerations have been factored into the design, but not with sufficient refinement.

All of the primary-system components within the primary containment must be physically supported in such a way as to accommodate thermal expansion effects and major disturbances, such as earthquakes, without loss of integrity. Although the internal construction of the cells is similar in principle to the interior of the PCRV for an HTGR, the primary system pressure boundary in an MSBR is independently contained by this structure rather than being a near-integral part of it. Consequently, additional design effort must be applied to equipment-support concepts.

8.3.2 Design methods

Commercial-scale MSBR's will be designed mechanically for a useful life of 30 years at temperatures as high as 1300°F with numerous thermal cycles. However, the design pressures are relatively low. These conditions are generally similar to those for HTGR's and LMFBR's, and considerable effort is being expended in those programs to develop design methods that will ensure that components and systems function safely and reliably under such conditions. Much of the technology that is being developed will be applicable, or at least adaptable, to MSBR design problems. However, the primary MSBR structural material (Hastelloy N) has different physical and aging characteristics than the materials to be used in either HTGR's or LMFBR's. Therefore, considerable effort will be required to adapt, demonstrate the applicability of, and apply appropriate design methods to MSBR systems.

Since the fuel composition in an MSBR is uniform throughout the core, the static neutronic design of such a core is relatively straight-forward and can be adequately handled by any of a number of existing static design methods. Available methods are expected to be adequate even for detailed static design calculations. However, the circulation of the fuel adds a level of complexity to the kinetic analysis of MSBR's. A good basis

exists for the kinetic analysis of circulating-fuel reactors, as evidenced by the successful design of the MSRE. Some additional methods development will be needed for the accurate analysis of larger reactors such as the reference MSBR, particularly for the larger and more rapid transients that must be considered for off-normal and accident conditions. In addition, methods will have to be developed to describe the transient behavior of an integrated MSBR plant from the core through the steam system.

8.3.3 Capital costs

Capital cost studies on molten-salt reactor plants have been made in recent years by several independent organizations. ORNL estimated the costs for the 1000-MW(e) reference design. Independently, Black and Veatch, the Reactor Assessment Panel of the Edison Electric Institute, and the Molten-Salt Group of Ebasco estimated the capital costs of MSBR systems. The conclusions from all these studies were that MSBR's appear to be economically attractive in the U.S. power economy. However, each of these studies was necessarily limited in precision by the state of development of the conceptual design that was subjected to analysis. Such limitations will continue to exist until MSBR's reach commercial application, but the levels of uncertainties can be expected to diminish as the reactor design evolves. Therefore, the capital costs, and all other aspects of MSR economics, should be frequently reassessed to ensure that design and development efforts are being applied to systems that are, in fact, attractive.

An important aspect of the capital (and operating) cost assessment of MSR's is determining the impact which various design options have on cost. The reference MSBR uses a particular design configuration, a particular secondary coolant, and a particular steam cycle. However, various alternatives have been, and will continue to be, advanced from time to time. Among the possible alternatives that have been suggested are converter and simple burner reactors, smaller or multi-use reactors, alternate secondary coolants, systems with two (different) intermediate coolant circuits in series, and alternate steam cycles. The economic effects of such alternatives, singly and in various combinations, should be examined to provide a sound basis for choosing the most desirable system(s) to be developed.

8.4 TASK GROUP 7.1 DESIGN STUDIES OF MSR POWER PLANTS

8.4.1 Objective

The ultimate objective of design studies of MSR's is to be able to design a dependable, safe, molten-salt breeder reactor that will produce excess fissile material from fertile thorium at a sufficient rate to contribute significantly to the U.S. electric power demands. The reactor must have a capital cost that is competitive with other types of electrical generating plants of comparable size and the operating costs must also be

competitive with such plants. In attaining this objective, it is obviously necessary to develop the technology, including viable components to be used in such a plant. The contributing chemical, materials, processing, technology, and related programs are discussed in other sections of this program plan.

8.4.2 Schedule

The design studies will be concerned with a number of separate reactors. (See also Fig. 8.2.1 for a diagram showing the interrelation of these activities). The initial advanced conceptual studies, in conjunction with accomplishments in other technology areas, would be expected to provide a basis for and approval of continuation of component technology development on a larger scale. After receipt of such approval, the preliminary conceptual design for the demonstration reactor would be carried out and the major features of the molten-salt test reactor (MSTR) would be defined. The next step would be the conceptual design of the MSTR mockup as a lead-in to its detailed design and construction. This facility, which would not be operated as a critical reactor, would permit partial and, in some cases, complete testing of full-scale MSTR components in a reactor-like environment. Simultaneous with operation of the MSTR mockup, other aspects of operation and testing of developmental equipment would be carried out in the Components Test Facility (see Section 10). After operation of the MSTR, a demonstration reactor plant would be constructed and operated. The schedule for this task group, Table 8.4.2, indicates work done at ORNL and also work anticipated to be done by industrial organizations.

8.4.3 Funding

The operating fund requirements for design studies are shown in Table 8.4.3. The initial design effort would begin at a low level in FY 1974 and increase slowly until efforts associated with major facilities are undertaken. However, since the construction design efforts for those facilities are included in other areas (see Sections 13, 14, 15) the funding for work in this activity does not reach a high level. As work on the major facilities becomes the primary effort, the required support for this activity declines, but some support must be maintained to provide surveillance, monitoring, and technical guidance of other activities.

8.4.4 Task 7.1.1 ORNL studies of 1000-MW(e) MSBR

The evolution of molten-salt reactors is expected to proceed from an MSTR mockup, to the MSTR, to a demonstration reactor, and finally to commercial plants. However, the incentive for following this path derives from the attractiveness of the final objective system — the 1000-MW(e) breeder reactor. In addition, the intermediate reactor systems will all be designed and operated to further the development

Table 8.4.2. Schedule for work in Task Group 7.1 - Design studies for MSR power plants

	Fiscal year											
	1975	1976	1977	1978	1979	1980	1981	1982	1983	1984	1985	1986
7.1.1 ORNL studies of 1000-MW(e) MSBR												
7.1.1.1 Overall conceptual design		_____										
7.1.1.2 Core design			_____									
7.1.1.3 Primary system layout			_____									
7.1.1.4 System structure and support			_____									
7.1.1.5 Rejection of radiation heat			_____									
7.1.1.6 Design alternatives			_____									
7.1.1.7 Demonstration reactor				_____								
7.1.2 Industrial studies of 1000-MW(e) MSBR												
7.1.2.1 System design description and cost analysis		_____										
7.1.2.2 Recommended research and development program		_____										
7.1.2.3 Safety analyses		_____										
7.1.3 ORNL study of Molten-Salt Test Reactor												
7.1.4 Industrial study of Molten-Salt Test Reactor				_____								
7.1.5 Studies of alternate designs and uses for MSR's		_____										

Table 8.4.3. Operating fund requirements for Task Group 7.1 -- Design studies of MSR power plants
(costs in 1000 dollars)

	Fiscal year											
	1975	1976	1977	1978	1979	1980	1981	1982	1983	1984	1985	1986
7.1.1 ORNL studies of 1000-MW(e) MSBR												
7.1.1.1 Overall conceptual design	60 ^a	140 ^a	64	32								
7.1.1.2 Core design			8									
7.1.1.3 Primary system layout			8									
7.1.1.4 System structure and support			8									
7.1.1.5 Rejection of radiation heat			8									
7.1.1.6 Design alternatives			16	12								
7.1.1.7 Demonstration reactor			18	32	64	128	150	200	200	150	125	
Subtotal 7.1.1	60	140	130	76	64	128	150	200	200	150	125	
7.1.2 Industrial studies of 1000-MW(e) MSBR												
7.1.2.1 System design description and cost analysis	(100) ^b	(350)	(200)									
7.1.2.2 Recommended research and development program	(50)	(50)										
7.1.2.3 Safety analyses	(50)	(100)	(100)									
Subtotal 7.1.2	(200)	(500)	(300)									
7.1.3 ORNL study of Molten-Salt Test Reactor				101	139	265	250	215	195	125	100	
7.1.4 Industrial study of Molten-Salt Test Reactor												
7.1.5 Studies of alternate designs and uses for MSR's		70	40									
Total operating funds for Task Group 7.1	60	210	170	177	203	393	400	415	395	275	225	

^aIncludes engineering analysis in support of safety studies and technology development.

^bFigures in parentheses represent industrial participation and are totaled separately.

of the breeder technology. Consequently, it is important to have as complete and detailed a conceptual design as possible for the breeder to permit accurate assessment of its value to the U.S. power economy and to help establish the design and performance requirements of the developmental plants. The work in this task is directed toward the production of an advanced conceptual design for a 1000-MW(e) MSBR and a demonstration reactor.

8.4.4.1 Subtask 7.1.1.1 Overall conceptual design

A reference conceptual design was produced by ORNL,⁴ but that design was based on particular requirements (e.g., for core moderator design and equipment function, support, and layout) that are not necessarily optimum. Specific portions of the design which should be reexamined, and possibly revised, are discussed in other subtasks of this general task. The initial work in Subtask 7.1.1.1 will be directed toward a review of the reference system with emphasis on the process design. Interrelations between the steam cycle, the secondary coolant, and the primary salt will be studied further, and a comprehensive study of tritium management will be undertaken. Subsequently, as system design modifications are developed, they will be integrated into a compatible overall conceptual design that will be susceptible to detailed performance and economic assessment.

8.4.4.2 Subtask 7.1.1.2 Core design

The design criteria for an MSBR are determined by the neutronic performance requirements, with appropriate considerations of operational effects and maintenance needs. In the current reference concept, these requirements were implemented by a graphite-moderator arrangement for which it was assumed that the moderator in the core and blanket zones would be removed every four years, as a unit, and replaced with a new assembly. The reflector was designed for an initial fuel-volume fraction of 1%, but without detailed consideration of long-term changes due to irradiation effects. The moderator design will be reexamined in this subtask and modified, as required, to satisfy the following needs:

- a. graphite pieces that can be easily fabricated, coated if necessary, and adequately inspected before use in the reactor,
- b. graphite pieces, sub-assemblies, or assemblies that can be replaced with maximum safety (and with reasonable effort and cost) when the design life is reached,
- c. a graphite reflector that limits neutron leakage to acceptable levels and adequately protects the reactor vessel from fast-neutron damage during its life,
- d. appropriate distribution and orificing of salt flows throughout the core, and

- e. provision for regulating and shutdown control rods as required for operation and safety.

In addition, the design of the reactor vessel will be reviewed to ensure that requirements of fabricability and inspectability are met. The core design studies will be supported by neutronic design calculations (in Task 7.5.1) to ensure that the desired nuclear performance is met and by additional technology development work if needs are identified. A reduced-scale or a few-channel model of the core may be needed prior to the operation of the MSTR mockup to help demonstrate the adequacy of designs or to examine transient behavior. Such a model, if needed, would be incorporated in the Components Test Facility (see Section 10.12).

8.4.4.3 Subtask 7.1.1.3 Primary system layout

The layout of the primary system in the current reference design represents a compromise between minimum fuel volume and a 30-year design life in the face of normal and abnormal stresses and stress cycling — with additional constraints of simplicity, inspectability, and maintainability. In this subtask, the reference arrangement will be reviewed to determine, first, if these design criteria have in fact been met. In particular, steady-state and transient stress analyses will be performed to verify the estimate of design life.

Alternate layouts will also be examined to determine whether simpler and/or more economical arrangements can be devised. It has been suggested, for example, that pipe and vessel liners in high-stress regions might reduce thermal stresses and permit a more compact arrangement. The attendant saving in fuel inventory would, in this case, have to be weighed against the added system complexity to judge the value of such a concept. Such tradeoffs will be evaluated for this and other layouts.

8.4.4.4 Subtask 7.1.1.4 System structure and support

The structural design of the major components and the methods for supporting them inside the insulated and heated containment cells require additional analysis for the reference design MSBR. The proposed arrangement of suspension from above appears to offer simplicity but may have disadvantages in terms of maintenance and seismic restraint. The reference and alternate designs will be studied in this subtask to ensure that a viable concept is adopted.

8.4.4.5 Subtask 7.1.1.5 Rejection of radiation heat

In this subtask the major components of the reference design will be examined to determine whether heat generated by nuclear radiation is satisfactorily rejected, and the conceptual designs will be modified

where necessary to ensure such heat rejection. Both normal and off-normal conditions will be considered. In normal operation, the principal consideration is surfaces that are not naturally cooled by flowing salt - positive cooling must be assured. Under off-normal conditions, particularly when the primary circuit is drained, less heat may have to be rejected but its rejection is likely to be more difficult. (The heat sources in the drained system arise from decay of deposited fission products.) The primary heat exchanger is one example of a component where some changes in conceptual design may be required in order to limit temperatures in the drained system. The drain-tank heat rejection system will also be carefully studied in this subtask. This system must operate effectively under all conditions and should remain operable under even the most severe accidents. A variety of alternative systems and coolants will be studied and the most promising combination selected for the reference design.

8.4.4.6 Subtask 7.1.1.6 Design alternatives

Although nominal choices have been established for all important features of the breeder concept, there are several areas in which alternative possibilities exist that cannot yet be eliminated from consideration. Among the more prominent areas of choice are the secondary coolant (nominally sodium fluoroborate) and the steam power cycle (nominally supercritical with 700°F feedwater). When alternatives are considered, as in Task 4.2.6 for alternate coolants (see Section 5), it will be necessary to examine their effects on the conceptual design of the system and components to provide a basis for factoring such effects into assessments of the alternatives. In this subtask, preliminary conceptual designs of components and subsystems will be generated to accommodate alternative choices of major system features. These designs will then be used in assessing the performance and economics of modified breeder concepts.

8.4.4.7 Subtask 7.1.1.7 Demonstration reactor

When the breeder concept is sufficiently well defined, it will be possible to prepare a preliminary conceptual design for a demonstration reactor which will ultimately provide the experience necessary for design of commercial reactors. However, since other conceptual design work will be in progress (Task 7.1.2), the demonstration breeder will represent a consensus judgment of the most desirable system. Most features of the demonstration system will be like those of the consensus commercial system but this is not a universal requirement. It may be desirable, for example, to design the demonstration plant for lower total power or for a shorter operating life. However, it is anticipated that much of the earlier conceptual design work will be directly applicable to the demonstration reactor. The "final" conceptual design will be used as a basis for selecting design criteria for a test reactor, as well as to more clearly estimate the cost and schedule for the demo plant.

8.4.5 Task 7.1.2 Industrial studies of 1000-MW(e) MSBR

In addition to the basic, conceptual reactor study, it is desirable to obtain as much industrial input and participation in the program as possible. Industrial organizations will be encouraged to participate in the program, and will be at least partially supported through ORNL subcontracts.

8.4.5.1 Subtask 7.1.2.1 System design description and cost analysis

A separate conceptual design for a 1000-MW(e) MSBR should be developed by industry, probably through an ORNL subcontract. The design should be sufficiently complete to identify unambiguously all major features of the reactor system, and should be arrived at independently, but not necessarily by ignoring previous work. Considerable progress toward such a design was made previously by an industrial group⁵ under subcontract to ORNL; however, the design was not fully developed. This work, and the results of ORNL studies, could serve as a starting point for further design effort. After the design is sufficiently well established, it should be fully described in a preliminary System Design Description (SDD) and evaluated in terms of performance and economics. This design and its analysis should be available before a detailed design effort is undertaken for subsequent development of MSR's.

8.4.5.2 Subtask 7.1.2.2 Recommended research and development program

Although the conceptual designs should rely primarily on available technology, some credit should be taken for technical developments which are expected to occur over the next two to five years (e.g., demonstrations of Hastelloy N suitability and chemical processing methods). Despite the taking of such credit, the detailed studies required to produce an SDD can be expected to reveal inadequacies in the existing technology, as it is applicable to MSR's. These inadequacies should be reduced to a recommended program of research and development which would be prepared and documented in this subtask.

8.4.5.3 Subtask 7.1.2.3 Safety analysis

An independent analysis of the safety of MSBR's would be made by industrial participants under this subtask. The analysis would be based, initially, on available conceptual designs and would subsequently be extended to examine possible differences associated with design variations. This study should begin with an appraisal of the basic safety considerations for MSBR's and extend through transient analysis of several postulated accidents which could have safety significance for such systems. The results of the study would be documented.

8.4.6 Task 7.1.3 ORNL study of MSTR

As a result of the various studies of MSBR's, it should be possible to describe a "most probable" breeder reactor — that is, one that could be designed, built, and safely operated with acceptable breeding and economic performance. Those studies will also identify specific aspects of the technology that should be proved in a demonstration reactor and developed to the demonstration stage in an MSTR. The purpose of this subtask is to evolve a conceptual design of an MSTR that incorporates all the features whose development and testing are required for the demonstration plant.

The test reactor would probably be designed to operate at a moderate power level (possibly a few hundred thermal megawatts) to generate "breeder quality" steam but not necessarily electricity. The system would likely be equipped with extra instrumentation and testing facilities, along with equipment for imposing transient conditions that would not usually be encountered in normal operation. Breeding, as such, would not have to be a design objective since it is believed that verification of a predicted conversion ratio would demonstrate the adequacy of the neutronic design methods. Important design objectives would be operation at breeder power densities, neutron fluxes, and temperature differences; components would have to be large enough to test design techniques, manufacturing capability, and performance characteristics.

The ORNL conceptual design, in conjunction with other independent conceptual designs, would be used as a basis for specifying and guiding the detailed design of an MSTR.

8.4.7 Task 7.1.4 Industrial study of MSTR

In this task, an independent industrial study of the MSTR would follow close behind the ORNL study to allow for criticism of the initial effort and the careful consideration of possible alternatives. Although the basic design objectives for this study would be similar to those for the ORNL work, the industrial view of testing needs may differ and the separate implementation of the objectives would provide additional options for the detailed design. This study could be, but would not have to be, performed by the same organization that carried out the breeder conceptual study.

8.4.8 Task 7.1.5 Studies of alternate designs and uses of MSR's

From the standpoints of resource utilization and overall economy, the most likely long term application for MSR's is the single-fluid breeder. However, other designs and uses should be examined to determine whether shorter-term applications exist for simpler, smaller, or special purpose systems. Among the alternate systems to be examined conceptually in this task are low-power-density converters, simple plutonium burners, and modest-size process heat systems.

The breeder reactor requires periodic replacement of high-quality moderator graphite and continuous operation of an integrated, on-line chemical processing plant. The difficult task of graphite replacement could be avoided if the core were sufficiently large and the power density sufficiently low to permit a 30-year graphite life; and the on-line processing plant could, in principle, be replaced by periodic batch reprocessing of the fuel on a cycle of a few years. The conversion ratio for such a system would be only about 0.9 to 0.95 (the low power density prevents the breeding ratio from decreasing as much as it would if only on-line processing were eliminated), although the capital costs could be significantly lower than for the breeder. This system would be examined to determine whether the associated power costs would be sufficiently attractive to justify further study.

A slightly simpler system could result if a reactor were designed to simply "burn" plutonium that is produced in LWR's. It appears that such burning could be accomplished more cheaply in MSR's than in other systems, but such systems should be examined more carefully.

The high temperatures attainable in MSR's may offer the possibility for process heat generation, and small systems may offer some advantages for multipurpose heat and power applications. Again, studies should be made to evaluate the desirability of developing MSR's for these purposes.

8.5 TASK GROUP 7.2 DESIGN TECHNOLOGY

8.5.1 Objectives

The objectives of the work in this task group are the development of design and performance criteria for components, subsystems, and systems to be built into MSR's and the development of methods for analyzing and designing such items. Current design data and related information will be maintained and documented as required.

8.5.2 Schedule

Some work is currently being done in this task group and considerably more will be required as the design characteristics of MSR's evolve from the work in Task Group 7.1. This work is expected to continue throughout the time span of the MSR program. The breakdown of the effort among the various tasks and subtasks is shown in Table 8.5.2.

8.5.3 Funding

Although the work in this task group extends over a long time period, the level of effort, as shown in Table 8.5.3, is relatively modest; a number of the tasks require only part-time effort. The principal effort is associated with the development and formalization of design criteria and methods.

Table 8.5.2. Schedule for work in Task Group 7.2 - Design technology

	Fiscal year												
	1975	1976	1977	1978	1979	1980	1981	1982	1983	1984	1985	1986	
7.2.1 Establish design bases for equipment for 1300°F operation													
7.2.1.1 Design criteria													
7.2.1.2 Design methods													
7.2.2 Compile design properties													
7.2.2.1 Fuel salt													
7.2.2.2 Coolant salt													
7.2.2.3 Graphite													
7.2.2.4 Hastelloy N													
7.2.2.5 Other reactor materials													
7.2.3 Design reports on selected MSR systems													
7.2.4 Compilation of cost data and analysis of plant costs													
7.2.5 Molten-Salt Reactor information system													

Table 8.5.3. Operating fund requirements for Task Group 7.2 -- Design technology
(costs in 1000 dollars)

	Fiscal year											
	1975	1976	1977	1978	1979	1980	1981	1982	1983	1984	1985	1986
7.2.1 Establish design bases for equipment for 1300°F operation												
7.2.1.1 Design criteria			65	64	32							
7.2.1.2 Design methods	50	20	32	—	—							
Subtotal 7.2.1	50	20	97	64	32							
7.2.2 Compile design properties												
7.2.2.1 Fuel salt		5	5	3	2	2	2	2	2	2	2	2
7.2.2.2 Coolant salt		4	4	3	3	2	2	2	2	2	2	2
7.2.2.3 Graphite			3	2	3	2	2	2	2	2	2	2
7.2.2.4 Hastelloy N		4	4	2	3	2	2	2	2	2	2	2
7.2.2.5 Other reactor materials			4	2	2	2	2	2	2	2	2	2
Subtotal 7.2.2		13	20	12	13	10	10	10	10	10	10	10
7.2.3 Design reports on selected MSR systems			20	32	32	32						
7.2.4 Compilation of cost data and analysis of plant costs		90	61	32	32	21	33	33	33	33	33	
7.2.5 Molten-Salt Reactor information system		34	32	32	32	32	32	32	32	32	32	
Total operating funds for Task Group 7.2	50	157	230	172	141	95	75	75	75	75	75	

8.5.4 Task 7.2.1 Establish design bases and methods for equipment for 1300°F operation

This task involves principally, two activities. The first is the development of design and performance criteria for equipment which will operate at the higher temperatures and the second is the development of design methods for meeting the criteria.

8.5.4.1 Subtask 7.2.1.1 Design criteria

The conceptual designs of MSR systems will establish the service conditions and many of the performance requirements for the reactor equipment, including such items as chemical environment, temperature, pressure, and material flow rates. Under this subtask, the relevant requirements for each component or system will be assembled and compiled into a set of design criteria. This work will be done in close cooperation with the design and development efforts to ensure that realistic criteria are established which meet the design needs and are capable of implementation.

8.5.4.2 Subtask 7.2.1.2 Design methods

Much of the equipment in an MSR will be expected to operate for up to 30 years at conditions which are near the limits of applicability of current design methods. Work is currently being done in other USAEC programs (notably the LMFBR and HTGR programs) to develop methods for (1) designing equipment for long-term high-temperature service, and (2) analyzing designs to demonstrate their adequacy. To the maximum extent possible, these methods will be adopted and applied to MSR program needs. Additional work will be done to extend the range of capability if it is required and to demonstrate applicability of the methods to materials and components of interest to MSR's.

8.5.5 Task 7.2.2 Compile design properties

A complete, accurate, and current set of design-related properties of all materials of interest in MSR systems must be maintained. These will be used extensively in developing conceptual designs for components and systems and in defining needs for equipment and technology development. Conversely, the design and development efforts will help to establish needs for specific properties and the accuracy requirements. This task provides for the compilation of the relevant data and its distribution to users within the program.

8.5.5.1 Subtask 7.2.2.1 Fuel salt

Properties of the nominal fuel salt are fairly well established, and all physical and chemical properties will be tabulated and made available to the prospective users.

8.5.5.2 Subtask 7.2.2.2 Coolant salt

There is uncertainty concerning the optimum coolant-salt composition, and for some time the properties of several alternate secondary coolants will be considered. Properties of the coolant that is finally chosen will be collected as they become available.

8.5.5.3 Subtask 7.2.2.3 Graphite

The quality of the graphite used in an MSR has a direct bearing on the reactor plant design. Isotropic graphite with good radiation-damage resistance will allow the power density in the reactor to be higher and therefore will, by lowering the specific fuel inventory, improve the nuclear performance of the plant. Also, low permeability (coated) graphite will improve the neutron economy by lowering neutron losses to xenon. The characteristics of potential graphites for MSR's will be tabulated and made available. Needs for additional data will be determined.

8.5.5.4 Subtask 7.2.2.4 Hastelloy N

The structural alloy for the MSR primary salt circuit is expected to be a modified Hastelloy N whose development is discussed in Section 2. When the reference alloy has been adequately tested and proven, its properties (strength, creep characteristics, thermal properties, radiation resistance, etc.) will be collected in a form suitable for the relevant design work, including the design of developmental items.

8.5.5.5 Subtask 7.2.2.5 Other reactor materials

Physical and chemical property data must also be compiled for a variety of other materials of interest in MSR's. Structural materials other than Hastelloy N may be selected for portions of the primary and secondary systems; reactor control materials will be needed; special materials may be specified for valve seating and bearing surfaces; and many other materials will be needed.

8.5.6 Task 7.2.3 Design reports on selected MSR systems

In a molten-salt breeder plant, as in any reactor plant, there are many supporting systems that must be specified and designed. As these systems become identified and conceptual designs are completed, the systems will be described in autonomous design reports which emphasize the performance requirements and criteria. Systems in this category include the auxiliary power system, the after-heat removal system, and the fission-product handling system. In many cases, reports on these systems will constitute a basis for further discussion in draft SDD's.

8.5.7 Task 7.2.4 Compilation of cost data and analysis of plant costs

The anticipated capital and operating costs of commercial MSBR's are expected to be important factors in guiding development activities within the MSR program. Moreover, since MSBR costs are likely to be compared with costs of other energy systems, it is essential that cost estimates be as realistic as possible and that they accurately reflect the available technology. Thus, capital and operating cost estimates will be made as early as the conceptual designs are sufficiently advanced, and the estimates will be updated and refined as necessary to incorporate additional information that has been developed. Established procedures will be used for estimating costs so that the results will be suitable for comparisons with estimates for other systems. In addition to the cost estimates for reference concepts, data will be generated to permit economic evaluations of tradeoffs associated with various design alternatives (e.g., higher-cost secondary coolant vs. simpler or less expensive equipment in the secondary system).

8.5.8 Task 7.2.5 Molten-salt reactor information system

A computerized data set containing abstracts of a large number (currently 373) of MSR-related documents is on file at ORNL. This data set, designated MSRIS for Molten-Salt Reactor Information System, was established to provide program participants with a readily accessible, computer-searchable summary of most of the technical information that is directly relevant to MSR's. Although no complete documents are stored in the system, information is provided about the sources and availability of documents. This system, which can be made accessible (via telephone) to qualified participants outside ORNL, will be updated on a continuing basis to ensure maximum utility of the information.

8.6 TASK GROUP 7.3 CODES AND STANDARDS

8.6.1 Objectives

Codes and standards for the design, construction, operation, and maintenance of nuclear power reactors have been and continue to be under development throughout the nuclear industry. Many of these are generally applicable to all nuclear systems, including MSR's, but many others are applicable only to specific reactor types. Regardless of their range of applicability, the ultimate purpose of such standards is the same — to ensure adequate safety and reliability in the systems to which they are applied. The objective of the work in this task group is the establishment of such standards and codes, specifically applicable to MSR's, as may be required or desirable to ensure for MSR's the same levels of safety and reliability that are required in other reactor systems.

8.6.2 Schedule

The initial work of establishing needs for standards and preparing preliminary criteria could begin immediately, but, as shown in Table 8.6.2, no direct effort is anticipated before FY 1977. This work would continue for the duration of the program with the major emphasis occurring when material code cases are prepared and when standards are set prior to the design and construction of specific nuclear facilities or major developmental facilities.

8.6.3 Funding

As indicated in Table 8.6.3, the funding for this work will remain at a low level until FY 1979, when a code case will be prepared for modified Hastelloy N. As work related to modified Hastelloy N is completed, that support will decline, but additional support will be required to develop preliminary standards for the MSTR and for the demonstration reactor, and for upgrading and refining the resulting standards.

8.6.4 Task 7.3.1 Standards for MSTR

The entire primary system of the MSTR will be designed and built in compliance with all applicable parts of the ASME Boiler and Pressure Vessel Code, Section 3, for Class I components. Other applicable sections of the ASME Code will be used, as appropriate, for other portions of the system. These code requirements will be supplemented by applicable AEC-RRD standards, AEC Regulatory Guides, and ANS standards.

The MSR is currently unique among U.S. power reactors in the use of a circulating liquid fuel and an on-line fuel processing facility. For these and other reasons, many standards may have to be modified, or generated for MSR's; for example:

1. Since radioactivity is dispersed throughout the primary system, MSR primary systems may be required to have lower leakage rates.
2. Standards for routine release of radioactivity probably should be modified to reflect the fact that the MSBR fuel cycle involves no off-site fuel reprocessing or refabrication.
3. The low excess reactivity in the core and the fuel drain capability may permit modification of requirements for control-rod shutdown capability.
4. Standards for post-shutdown cooling should be modified to reflect the fact that most of the afterheat is released in the drain tank after a drain and that the fuel salt provides considerable thermal inertia.

Table 8.6.2. Schedule for work in Task Group 7.3 - Codes and standards

	Fiscal year											
	1975	1976	1977	1978	1979	1980	1981	1982	1983	1984	1985	1986
7.3.1 Preparation of standards for Molten-Salt Test Reactor												
7.3.2 Preparation of standards for MSBR's												
7.3.3 Preparation of code cases												

Table 8.6.3. Operating funds required for Task Group 7.3 -- Codes and standards
(costs in 1000 dollars)

	Fiscal year											
	1975	1976	1977	1978	1979	1980	1981	1982	1983	1984	1985	1986
7.3.1 Preparation of standards for Molten-Salt Test Reactor			35	64	64	128	200	130	130	50	50	
7.3.2 Preparation of standards for MSBR's										150	150	
7.3.3 Preparation of code cases					64	64						
Total operating funds for Task Group 7.3			35	64	128	192	200	130	130	200	200	

5. Maintenance and in-service inspection procedures are likely to require different standards than for solid-fueled reactors.

After a thorough review of available standards and their adaptability to MSR's, needs for modified or additional standards will be identified and preliminary versions will be produced for application to the MSTR. The design, construction, testing, operation, and maintenance of that reactor will provide tests of the adequacy of the standards, as well as of the ability of MSR systems to conform to required standards.

8.6.5 Task 7.3.2 Preparation of standards for MSBR's

The standards and codes developed for the MSTR will be reviewed and revised to meet the needs of the commercial MSBR. This work will be based on the information and experience developed in preparing earlier versions of standards and the experience obtained from applying them to the MSTR. The usual review, trial use, and revision procedures will be employed in establishing MSBR standards.

8.6.6 Task 7.3.3 Preparation of code cases

Hastelloy N was used in the construction of the Molten-Salt Reactor Experiment which was operated at ORNL between 1965 and 1969, and a code case was submitted to cover that application. Before the next reactor can be built, additional code cases must be prepared for the modified Hastelloy N which will be used. A case must be submitted to obtain approval of the material as regards ASME Boiler and Pressure Vessel Code Section III, Case I, Section VIII, and the high temperature application covered in 1331-8, as well as the special section of RDT standard E-15-2.

It will probably require about two years of further study of the modified alloy before it will be possible to finalize its formulation. It is anticipated that two additional years will be required to obtain data from large commercial heats of the material and to prepare the code case (see Section 2, Task 1.4.3).

Additional code cases are also likely to be required. For example, the primary materials for the fuel processing plant are probably not covered by existing cases, and other materials that may be selected may require special consideration due to the nature of the proposed applications. Such cases will be prepared and submitted as required to obtain the approvals needed for the program.

8.7 TASK GROUP 7.4 LICENSING OF MSR's

8.7.1 Objective

All MSR's, including the MSTR and the demonstration reactor, will presumably be required to meet licensing criteria established for other power

reactors. It is, therefore, essential that the first plant to which these criteria are applied, the MSTR, be designed to comply with all licensing requirements, or at least the intent of the requirements. Since MSR's exhibit fundamental differences from solid-fueled reactors, some of the requirements may have to be "interpreted" to make them applicable to MSR's. It is the purpose of this task group to examine the licensing positions of the conceptual MSR's in sufficient detail to provide reasonable assurance that licensing applications can be acted upon favorably.

8.7.2 Schedule

The licensing study should begin after a reasonably firm conceptual design has been established for the MSBR in FY 1978 and will continue through FY 1985 in order to allow review with feedback to the design and development effort to continue until the state of the technology is such that a "trial" license application can be prepared. Depending on the results of that effort, additional work would probably be required to support the application for and receipt of the construction permit and operating approval for the MSTR. The actual preparation of applications for specific plants are not included in this task group.

8.7.3 Funding

The funding for this task group, Table 8.7.3, is tentatively set at a low level with additional support to prepare the "trial" application and to assist in the MSTR applications. As this work proceeds, if additional needs are identified, it will be necessary to increase the support for this task group.

8.7.4 Task 7.4.1 Studies of MSBR licensing position

The requirements for nuclear plant licensing will be carefully reviewed to identify any areas in which special interpretations may be needed to accommodate the unique features of MSBR's. After development of any such interpretations, the MSBR conceptual design will be examined to determine the extent to which it complies with licensing requirements and to identify any features that might require additional development or modification to enhance licensability. When the design and the technology are judged to be sufficiently well established, a trial set of licensing documents, including a draft PSAR, would be prepared. These documents would not be as comprehensive as those needed for a formal license application, but they should be adequate to define the basic licensing position of the reactor. These documents would be reviewed within the program, and an attempt would be made to obtain review by licensing agencies. Based on the results of such reviews additional work probably will be required to further enhance the licensing position so that there can be reasonable assurance that the MSTR can be approved for operation.

Table 8.7.3. Operating funds required for Task Group 7.4 -- Licensing of MSR's
(costs in 1000 dollars)

	Fiscal year									
	1977	1978	1979	1980	1981	1982	1983	1984	1985	1986
7.4.1 Studies of MSBR licensing position		32	128	192	250	200	200	200	200	200
Total operating funds for Task Group 7.4		32	128	192	250	200	200	200	200	200

8.8 TASK GROUP 7.5 NUCLEAR ANALYSIS OF MSR POWER PLANTS

8.8.1 Objectives

The objectives of the work in this task group are to provide workable neutronic designs for molten-salt reactor concepts under study and to determine the steady-state and transient performance characteristics of the designs. The design goals, in terms of breeding or conversion, fuel-cycle performance, power densities, neutron fluxes, physical size, etc., will be established by other design activities. This task group also provides for the development of calculational methods that may be needed to produce results with the required degrees of accuracy and precision.

8.8.2 Schedule

Neutronic studies (see Table 8.8.2) will be initiated along with the start of other preliminary conceptual design activities and will continue for the duration of the design studies to permit needed adjustments and refinements of the conceptual designs. The required level of effort is expected to be relatively low except for brief periods when studies of new or alternate concepts are initiated. At those times, additional effort will be expended to support the extra design work.

8.8.3 Funding

The funding required to support the anticipated nuclear analysis work is shown in Table 8.8.3.

8.8.4 Task 7.5.1 Analysis of 1000-MW(e) MSBR's

Computer codes and methods for static nuclear analyses of MSBR's are fairly well established, but as these studies continue, the codes will be revised as necessary and cross-section libraries updated. All analyses of MSBR's will be made to optimize one or more design parameters. Studies will include optimization of fuel-cycle cost, breeding performance, fuel inventory, doubling time, and chemical processing rate. These studies will also provide data on core reactivity coefficients and other properties that are important in the reactor kinetic behavior. Additional computations will then be made to define the kinetic response of the core to anticipated transient conditions. The models used for such computations and some of the results will be incorporated in more comprehensive models to examine the dynamic behavior of entire MSBR systems.

Table 8.8.2. Schedule for Task Group 7.5 - Nuclear analysis of MSR power plants

	Fiscal year								
	1975	1976	1977	1978	1979	1980	1981	1982	1983
7.5.1 Analysis of 1000-MW(e) MSBR's									
7.5.2 Control studies of MSR plants									
7.5.3 Analysis of alternate MSR designs									
7.5.4 Computer code development									
7.5.4.1 Static reactor calculations									
7.5.4.2 Dynamic reactor calculations									

Table 8.8.3. Operating fund requirements for Task Group 7.5 — Nuclear analysis of MSR power plants (costs in 1000 dollars)

	Fiscal year									
	1975	1976	1977	1978	1979	1980	1981	1982	1983	
7.5.1 Analysis of 1000-MW(e) MSBR's	12	60	33	33	33					
7.5.2 Control studies of MSBR plants				30	30	64	75	30		
7.5.3 Analysis of alternate MSR designs		40	30							
7.5.4 Computer code development										
7.5.4.1 Static reactor calculations			2	2	2	4				
7.5.4.2 Dynamic reactor calculations			30	30	30	60				
Subtotal 7.5.4			32	32	32	64				
Total operating costs for Task Group 7.5	12	100	95	95	95	128	75	30		

8.8.5 Task 7.5.2 Control studies of MSBR plants

Control studies of these plants involve many areas. With respect to neutronic processes, experience with two experimental MSR's showed that they were easily controlled, and this is expected to be the case for larger cores. However, plant control involves a great deal of interaction between the neutronic processes and other parts of the system. These interactive control processes for steady operation, normal maneuvering, and upset conditions will be extensively studied with the aid of analog, hybrid, and digital computer techniques to ensure that the conceptual designs provide adequately for control needs. This task interfaces strongly with Task Group 11.1 (see Section 12).

8.8.6 Task 7.5.3 Analysis of alternate MSR designs

Alternate MSR's are of two basic types, converters and plutonium burners. A uranium burner which uses no fertile thorium is of course possible, but would probably have little practical use. It is believed preferable to incorporate thorium in a uranium-fueled reactor and achieve some conversion. Non-breeder types of MSR's would be investigated in order to determine their probable economic impact. Analyses would be done to determine fuel-cycle costs and the performance of reactors designed for maximum simplicity and minimum capital cost.

There are potential uses for MSR's other than central station power generation. Many industries require large quantities of process steam at temperatures which suggest the use of MSR's for steam production. A parametric study of reactors of various sizes would be made to determine the economics of heat sources of this type.

Analyses of these alternate MSR's will be done following the breeder analyses, since MSBR development comprises the main line effort of the program.

8.8.7 Task 7.5.4 Computer code development

8.8.7.1 Subtask 7.5.4.1 Static calculations

Currently available methods for performing reactor statics calculations appear to be adequate for MSR conceptual design purposes, and no development of statics codes, per se, is anticipated. A general design code (ROD) is also available to perform parameter and fuel cycle studies. This code could be modified to a two-dimensional model in order to better analyze a multi-region reactor core. While the ENDF cross-section library is expected to be adequate for design calculations, sensitivity analyses would be done to determine the effect on neutron economy of uncertainties in the cross section data.

8.8.7.2 Subtask 7.5.4.2 Dynamic reactor calculations

It is possible that additional codes will be needed to handle the kinetic or dynamic analyses that will be needed for large MSR's. There are many transient and off-design calculations for which nuclear analyses must be performed, and this task provides for the development of programs to supply the analysis capability.

REFERENCES FOR SECTION 8

1. *The Development Status of Molten-Salt Breeder Reactors*, ORNL-4812 (August 1972).
2. R. C. Briant, A. M. Weinberg et al., "The Aircraft Reactor Experiment," (4 articles), *Nucl. Sci. Eng.* 2(6): 797-853 (November 1957).
3. R. C. Robertson et al., *Two-Fluid Molten-Salt Breeder Reactor Design Study (Status as of January 1, 1968)*, ORNL-4528 (August 1970).
4. R. C. Robertson, ed., *Conceptual Design Study of a Single-Fluid Molten-Salt Breeder Reactor*, ORNL-4541 (June 1971).
5. Ebasco Services, Inc., "1000 MW(e) Molten Salt Breeder Reactor Conceptual Design Study: Final Report - Task 1," February 1972.

9. GRAPHITE DEVELOPMENT

9.1 INTRODUCTION

The graphite in a single-fluid MSBR serves no structural purpose other than to define the flow patterns of the salt and, of course, to support forces resulting from its own weight and momentum transfer from the flowing salt. The requirements on the material are dictated most strongly by nuclear considerations, namely stability of the material against radiation-induced distortion, nonpenetrability by the fuel-bearing molten salt, and nonabsorption of xenon into the graphite. The practical limitations on meeting these requirements in turn impose conditions on the core design, specifically the necessity to provide for periodic graphite replacement and to limit the cross-sectional area of the graphite prisms.

9.1.1 Objective

The primary objectives of this activity are to develop a core moderator graphite having good dimensional stability under neutron irradiation and a low permeability to ^{135}Xe which can be produced commercially at an acceptable cost.

9.1.2 Scope

The scope of this work will include studies of a basic nature concerning damage mechanisms, fabrication studies to develop graphite with improved dimensional stability, development of sealing methods for reducing the permeability of the graphite to ^{135}Xe , and measurements of the physical properties of graphites having potential for MSBR application.

9.1.2.1 Task Group 8.1 Basic graphite studies

These studies will be concerned with basic irradiation damage mechanisms in graphite. Single crystals will be used to determine the types and numbers of defects produced during irradiation. Annealing kinetics will be observed by transmission electron microscopy.

9.1.2.2 Task Group 8.2 Graphite base stock development

This work will involve a study of the basic raw materials and fabrication processes used in making graphite. Commercial and experimental graphites will be characterized and irradiated, and dimensional and physical property changes will be measured. The goal will be to correlate starting material and fabrication variables with dimensional stability during irradiation.

9.1.2.3 Task Group 8.3 Sealing of graphite for permeability reduction

The absorption of ^{135}Xe by the core graphite can result in reduction of the breeding ratio. Most of the ^{135}Xe will be removed from the fuel salt by contact of the salt with helium, but it will likely be necessary to reduce the permeability of the graphite to prevent absorption of xenon by the graphite. It is likely that graphite with surface permeabilities as low as 10^{-8} cm²/sec will be required, and this low permeability can only be obtained by (a) surface coating the graphite with pyrocarbon, (b) impregnating the graphite with carbon, or (c) impregnating the graphite with salt. All of these techniques will be pursued to some extent.

9.1.2.4 Task Group 8.4 Physical properties

The physical properties of graphite cover a wide range of values due to the large number of starting materials and fabrication techniques used in making graphite. The physical properties of graphite provide useful information about the crystallographic structure and other properties. Similarly, the changes in physical properties during irradiation provide information about the crystallographic changes taking place. Thus physical properties such as thermal expansion, thermal conductivity, and electrical resistivity are very useful for characterizing graphites and for evaluating structural changes during irradiation. The changes of these properties are also of direct importance to the design of a reactor core, since they affect dimensional behavior and heat transfer. Work will be carried out in which graphite samples are alternately irradiated and physical properties measured.

9.1.2.5 Task Group 8.5 Evaluation tests for MSBR graphite

Several tests must be made on the grade of graphite chosen for a molten-salt test reactor. The work carried out in Task Group 8.1 through 8.4 will have involved small samples. Tests of a proof nature will be run on large pieces having the full cross-section of a moderator element. These tests will include long-term irradiation tests on uncoated and coated elements, and subsequent evaluation of the irradiated specimens.

9.2 PROGRAM BUDGET AND SCHEDULE

9.2.1 Schedule and key program milestones

The schedule for work on graphite development is shown in Table 9.2.1.1.

The key program milestones for this activity are listed in Table 9.2.1.2 and occur at the times shown in Table 9.2.1.1.

9.2.2 Budget

The operating fund requirements for this activity are shown in Table 9.2.2.1, and the capital equipment fund requirements are shown in Table 9.2.2.2. This includes capital equipment funds in the amount of \$300,000 in both FY 1980 and FY 1981 for construction of two facilities for in-reactor irradiation of large moderator graphite sections.

9.3 MATERIAL REQUIREMENTS, BACKGROUND, AND STATUS OF DEVELOPMENT

9.3.1 Material requirements

Graphite used in the highest power density portion of the core of the reference design MSBR will be exposed to flowing fuel salt at temperatures up to 1300°F, will receive fast neutron fluences of about 3×10^{22} neutrons/cm², and will be in contact with fuel salt containing ¹³⁵Xe. It is necessary that the graphite be chemically inert to the salt, that it maintain reasonable dimensional stability and integrity during exposure to this high neutron fluence, and that it have a low permeability to ¹³⁵Xe under the operating conditions.

Salt and graphite have been shown to be compatible by numerous experiments with the most convincing proof being the operation of the MSRE.¹ Graphite removed from the MSRE after 5 years of operation retained preinstallation machining marks and documented surface imperfections. Salt penetration into the graphite is prevented by surface tension forces if the entrance pore diameters to the internal void structure of the graphite are of the order of 1 μm or less. Seepage of fuel salt into the graphite would lead to local hot spots which could easily attain temperatures of 1100-1200°C at which the graphite damage rate is increased by a factor of two over that at 700°C.² Fortunately the pore size requirement is easily met by many high-quality, fine-grained graphites, and this requirement leads to no design or material restrictions.

Radiation damage in graphite has been studied extensively since 1945 relative to the Hanford production reactors, and more recently under the various European and American gas-cooled-reactor programs.³ In the mid 1960's it became increasingly apparent that graphite has a finite lifetime in a fast neutron environment, and that the anisotropically induced

Table 9.2.1.1. Schedule for work on graphite development

	Fiscal year											
	1975	1976	1977	1978	1979	1980	1981	1982	1983	1984	1985	1986
8.1 Basic graphite studies						▼ ^a						
8.2 Graphite base stock development			▼ ^b			▼ ^c						
8.3 Sealing of graphite for permeability reduction				▼ ^d								
8.4 Physical properties						▼ ^e						
8.5 Evaluation tests for MSBR graphite						▼ ^f	▼ ^g					

Table 9.2.1.2. Milestones for graphite development

Milestone	Description
a	Develop damage model for graphite single crystals relating damage due to electron and neutron irradiation
b	Choice of best available commercial graphite (reference) for MSBR use
c	Begin fabrication of experimental quantities of graphites with improved resistance to irradiation damage
d	Choice of process for reducing graphite permeability
e	Measurement of physical property variation of reference graphite in irradiated and unirradiated conditions
f	Begin irradiation of prototype moderator element made of reference graphite
g	Begin irradiation of sealed (low permeability) prototypic moderator element made of reference graphite

Table 9.2.2.1. Operating fund requirements for graphite development
(costs in 1000 dollars)

	Fiscal year												
	1975	1976	1977	1978	1979	1980	1981	1982	1983	1984	1985	1986	
8.1 Basic graphite studies			50	50	100	200							
8.2 Graphite base stock development		130	130	150	150	445	445	445	445	445	445		
8.3 Sealing of graphite for permeability reduction		290	304	339	353	350	250	200	200	150	150		
8.4 Physical properties		30	30	40	40	115	115	115	115	115	115		
8.5 Evaluation tests for MSBR graphite						100	475	500	500	500	400		
Total operating funds for graphite development		450	514	579	643	1210	1285	1260	1260	1210	1110		

Table 9.2.2.2. Capital equipment fund requirements for graphite development
(costs in 1000 dollars)

	Fiscal year												
	1975	1976	1977	1978	1979	1980	1981	1982	1983	1984	1985	1986	
8.1 Basic graphite studies			50	75	25								
8.2 Graphite base stock development		20	30	35	45	140	140	130	60	50	50		
8.3 Sealing of graphite for permeability reduction		20	35	100	20	100	20	20	100	20	20		
8.4 Physical properties		20	30	20	30	20	20	20	10	20	10		
8.5 Evaluation tests for MSBR graphite						370	390	40	40	40	40		
Total capital equipment funds for graphite development		80	145	230	120	630	570	210	210	130	120		

crystallite growth resulting from irradiation damage ultimately causes gross dimensional changes in the polycrystalline bulk material. The fluence that is defined as the useful lifetime of the graphite depends somewhat on the failure criterion employed. The gradual deterioration of the material would first be reflected in increased xenon absorption, followed by salt penetration and eventually loss of mechanical integrity. The definition presently used, that the material undergo no significant radiation-induced bulk expansion, is certainly a conservative assumption. If the graphite lifetime were to be equal to the design plant life of the reference design MSBR (which has a peak power density of 100 watts/cm³), the graphite would experience a damage fluence of about 3×10^{23} neutrons·cm⁻², which is about ten times what the best material will withstand.

The approach for excluding ¹³⁵Xe from the interior of the graphite with its attendant improvement in breeding ratio is discussed in detail in Section 8. Translated to a materials requirement, however, xenon exclusion implies effective gas permeabilities of 10⁻⁸ cm²/sec helium STP or lower, which requires maximum pore entrance diameters of 0.01 μm or less. Such pore sizes are not attainable in the ordinary fabrication of bulk graphite. The requirement can be easily met by pyrolytic deposition of carbon onto a bulk graphite, although it has not yet been demonstrated that such coatings have adequate irradiation stability.

The existence of a graphite lifetime which is lower than the desired plant life forces the reactor designer to accept low power densities or to make provisions for periodic removal of the graphite. The latter approach has been adopted for the reference design MSBR as discussed in Section 8. The requirement for salt exclusion, and thereby a fine-grained graphite, also determines that the geometric cross section of the graphite prisms be kept low. This is necessitated by the inability to control microstructure to the desired degree in forming and heat-treating graphite members having large cross sections. Small cross sections also have the advantage of minimizing thermal gradients in the graphite during reactor operation and thus reducing the rate at which radiation damage occurs.

In the several MSR design studies carried out to date, the problems of graphite removal and prism geometry have been approached in several different ways.⁴⁻⁶ Mechanical analyses⁷ have indicated there are no significant thermal or radiation-induced stresses in graphite in any of the designs.

9.3.2 Background

9.3.2.1 General

Graphite has been employed as a nuclear material for as long as there have been reactors. It formed the moderator in the Stagg Field experiment and in the prototype Oak Ridge Graphite Reactor. The first extensive

experience with graphite was acquired in the Hanford production reactors and somewhat later in the British gas-cooled reactors, albeit at lower temperatures and fluences than apply to MSR's.

More recently the Dragon Reactor initiated the use of graphite at temperatures in the 1000°C range, followed shortly by the Peach Bottom Reactor in the U.S. and the AVR Reactor in Germany. Currently, gas-cooled reactors are being designed or operated which have graphite temperatures in the 1200-1300°C temperature range.

Much of the experience and data obtained in the gas-cooled reactor program is directly applicable to MSR's. In particular, data obtained at Hanford in the mid-1960's spanning the temperature range 300-1100°C first indicated the finite lifetime of graphite resulting from neutron-induced damage, i.e., its eventual dimensional expansion and loss of mechanical integrity.

In late 1968, a program was initiated at ORNL to evaluate graphites for molten-salt breeder reactor application, and more specifically, to determine what limitations improved graphite might impose on reactor design. A development program was proposed⁸ to demonstrate feasibility of improving graphite by 1975, and to bring such improvements to commercial application by 1980. However, the development program has not been fully implemented due to funding limitations. Nevertheless, considerable progress has been achieved toward demonstrating the capability of existing materials to meet MSBR requirements and to delineate areas for future development.

9.3.2.2 Basic graphite studies

Techniques were developed at ORNL for irradiating graphite with electrons in an electronmicroscope and simultaneously observing the structural changes as they occurred. Techniques were also developed for controlling the specimen temperature, so that annealing and clustering of defects could be observed. The studies carried out showed that the reported value for the displacement energy for carbon atoms in a graphite lattice was likely in error. This physics parameter is basic in predicting the number of atomic displacements caused by a primary knock-on.

9.3.2.3 Irradiation damage studies

The basic irradiation damage phenomena in graphite arise from the extreme anisotropy of the crystal. The carbon atoms are arrayed in tightly bound hexagons in planar array. The planes are well-separated and weakly coupled. Interstitials produced by neutron bombardment move freely between planes and reintegrate as new planes. Vacancies left behind are collapsed. One is thus left with the picture of a single crystal expanding indefinitely in one direction and contracting in the other two with little change in net volume. Thus, in a polycrystalline material,

each crystallite is expanding and contracting in varying directions, and it is hardly surprising that the material eventually deteriorates. What is remarkable is its ability to withstand these changes. Partially oriented pyrolytic graphites irradiated in HFIR to fluences of 3×10^{22} neutrons/cm² at MSR temperatures expanded 500% in the preferred c-axis direction without losing mechanical integrity!

During the period 1963-1971, over eighty different experimental and commercially available graphites were irradiated in HFIR to establish their dimensional behavior.⁹ An understanding of the microstructural properties of graphite that are of significance to radiation damage has gradually emerged, and can be summarized as follows:

In the 600 to 800°C temperature range of interest to molten-salt breeder reactors, bulk graphites can be classified into three behavior modes depending on their fabrication history, namely conventional materials, black-based materials, and monolithic materials.⁸ Conventional materials include all normal commercial graphites that are formed from calcined coke or graphite fillers, bindered with thermosetting or thermoplastic materials, and subsequently heat treated. These materials may be isotropic or anisotropic, but show an immediate volume contraction during irradiation followed by rapid and catastrophic expansion. Their lifetimes are in the range from 1 to 2.5×10^{22} neutrons/cm² ($E > 50$ keV). The rate of volume expansion is characteristically parabolic with increasing fluence.

The second class, black-based graphites, employs carbon blacks as fillers. The individual blacks have a roughly spherical crystallite shape which is capable of withstanding high tangential strain. Depending on heat treatment temperature, these materials will first contract rapidly and then expand linearly with further irradiation. The difference in the expansion behavior from that of the more conventional graphites is tentatively explained by the ability of the black particles to withstand strain.

The third class, and the one of interest for MSBR applications, is the monolithic materials which appear to be binderless, or for which the filler material is chemically active and reacts with the binder. The result is an extremely homogeneous structure that is usually unmarked by microstructures. Under irradiation, these materials undergo a prolonged stable induction period before beginning a parabolic expansion period. The lifetimes of graphites of this class tested to date lie in the range of 2 to 3×10^{22} neutrons/cm² ($E > 50$ keV). The best materials of this type are invariably isotropic, and their induction period is attributed to their high microstrength and ability to flow plastically to relieve strain. The parabolic expansion of these materials and of the conventional graphites can be related to void generation as the structure finally fractures at the crystallite level.¹⁰

In summary, the general nature of damage in polycrystalline graphite is understood, and its relationship to microstructure is at least qualitatively demonstrated.

9.3.2.4 Fabrication studies

Based on the HFIR irradiation data, a program was initiated in 1970 to explore the fabrication of monolithic graphites with the specific aim of improving irradiation damage resistance. Small samples up to three inches in diameter were used, and the raw materials were limited to three cokes and several thermosetting or thermoplastic binders. The essence of the improved fabrication process is in the use of cokes in their uncalcined condition in which they are still chemically active. The chemical interaction between coke and binder and the similar shrinkage rates of the two during carbonization result in the desired monolithic structure.¹¹

These materials have undergone irradiation testing to fluence levels as high as 1.5×10^{22} neutrons/cm². To this level, the materials have been stable, and thus confirm our conclusions from hypotheses based on damage models.

9.3.2.5 Stresses and creep

The graphite core prisms in an MSBR are required for no structural purpose except to delineate the salt flow paths and to support their own weight when the reactor primary circuit is drained. However, the question remains as to the magnitude of thermal or radiation-induced stresses. These have been calculated with the reference design MSBR for conventional graphite at the worst position in the core, i.e., on the core center line just above the midplane.⁶ The calculated stresses are quite low and can be neglected. It is thus concluded that thermal and radiation-induced stresses are no problem even for the relatively poorly behaved conventional graphites for fluence levels up to the defined graphite lifetime (the time at which the fluence level reaches that required to cause expansion of the bulk graphite beyond its initial volume).

9.3.2.6 Sealing to prevent xenon absorption

The approach used to effectively seal graphite with respect to xenon permeation takes three forms: direct impregnation by hydrocarbons followed by heat treatment to leave a carbon relic in the pore, surface treatment to seal the pores at or near the surface, or impregnation with a liquid or solid salt to fill the pores.

Sufficient experience exists in the graphite industry to indicate the limitations of direct carbonaceous impregnation. The decomposing hydrocarbon generates gaseous products which must escape to the surface or produce rupture in the bulk graphite. The lowest practical xenon permeability which can be achieved by this approach is of the order of 10^{-6} cm²/sec, which is a factor 100 larger than required for adequately excluding xenon from MSBR graphite. This approach has therefore not been explored further in the MSR program.

The use of salts to fill the pores of the graphite has been looked at cursorily⁸ and is still being considered. The difficulty anticipated with this approach is that uranium may diffuse into the salt from the fuel salt. Nevertheless, it has been demonstrated that such a technique can reduce gas permeabilities to the desired range.

The use of pyrolytic decomposition of hydrocarbons has been extensively studied for reactor applications, primarily under the gas-cooled reactor programs. The background information on process parameters, properties, and irradiation behavior developed in that work forms the basis for the current work related to MSBR's. The first approach,¹² utilizing a gas impregnation process to fill the pores near the external surface of the graphite, was initially preferred over a coating process because of the greater resistance which the resulting graphite would have to handling damage. The process consists of alternately exposing the graphite to hydrocarbon gas and vacuum, thus effecting decomposition of the gas deep within the pores of the graphite. This approach has proven to be easily controllable and effective, and apparent permeabilities* in the 10^{-8} cm²/sec range and below are readily attained. Monolithic-type substrates were impregnated and irradiated in HFIR, however, a rapid increase in permeability during irradiation was observed.¹³ Dimensional measurement data readily indicated that in filling the pores the crystallites in the surface region of the base graphite had also been locked together which prevented the plastic flow necessary to relieve the intercrystalline strains produced during damage.

Coating of graphite was next investigated, utilizing base graphites and coating structures known to be dimensionally stable under irradiation. The initial irradiation results⁹ indicated limited success; a few samples retained their initial low permeabilities to the maximum fluence employed, about 2×10^{22} neutrons/cm², but the majority had permeabilities which were no better than that of the unimpregnated materials. It is now known that the coatings were flawed before irradiation, and a revised coating process was developed.¹⁴

*The permeabilities as used here are derived from gas flow measurements through both the sealed region and the remaining unaffected substrate graphite. The actual permeabilities at the sealed surface layer are probably a factor of 100 lower.

One of the recent major diagnostic advances has been development of scanning electron microscopes that are capable of examining graphite surfaces. The flawed samples alluded to above appeared perfectly sound under even the light microscope. However, under the scanning electron microscope, various types of flaws were readily apparent as well as changes in microstructure. The defects were found to be due to faulty gas circulation, soot inclusions, and the presence of sharp corners on the graphite cylinders being coated. It is believed that these factors have been eliminated in the current coating process, however, this has not been verified by irradiation of test samples.

9.3.2.7 Thermal conductivity measurements

It was anticipated initially that changes in thermal conductivity due to radiation damage under MSR conditions would be slight. Recent data, however, have implied this may not be the case,⁸ and experiments have been initiated in HFIR to determine the extent of the degradation in conductivity.⁹ Preliminary results imply the conductivity may decrease to about one third of the initial value.

The thermal conductivity of graphite is important in controlling the internal graphite temperatures, and thereby the rate of irradiation damage accumulation. The average dimensional change observed for a graphite prism undergoing radiation damage is essentially equal to that which would be observed if the prism were at its mean temperature throughout.⁷ Since damage rate increases with increasing temperature, it is desirable to minimize internal temperature gradients.

9.3.2.8 Manufacturing capability and costs

An extensive survey of various commercial graphites identified one graphite that is acceptable for the MSBR reference design, a second graphite that is acceptable but available only in limited sizes, and two other graphites which are potentially acceptable. Fortunately, these graphites involve four separate vendors.

Great Lakes Carbon Corporation's grade H-364 is available in the desired geometries and possesses a lifetime (before significant expansion occurs) of the order of 2.5×10^{22} neutrons/cm² ($E > 50$ KeV) at 715°C. This is 17% less than the graphite life specified in the reference design but is close enough to be compensatable by allowing more expansion, reducing the maximum power density, or replacing the graphite somewhat earlier. Poco grade AXF is the best commercial material which has been encountered and has a lifetime of the order of 3 to 3.5×10^{22} , but this material is currently available only in short lengths. Material submitted by Airco Speer and Pure Carbon Companies may also fall into the class of these graphites but to date these materials have been irradiated to a fluence of only 1.5×10^{22} . Their behavior appears to be similar to that of the best of the monolithic grades.

It has not been possible to obtain firm price estimates on the four grades of graphite which are potentially acceptable for the reference design MSBR, but they appear to fall into the range of \$5 to \$10 per pound of finished graphite, even on a first-order basis. Prices of \$5 per pound or lower appear to be probable if the market becomes sufficiently large to permit the graphite to be handled as a stock item.

With regard to pyrolytic coating or sealing, there is an existing industry already producing such coatings primarily for aerospace applications. However, the most irradiation-resistant type of coating (LTI, or low temperature isotropic) is produced using process parameters quite different from those in use by the existing industrial firm. Estimating the cost of coating operation is difficult since a process has not been developed, but it is believed that \$25 to \$30 per lb of finished graphite for the proposed slab geometry should cover the coating operation during its early development. Eventually, coating costs should drop to \$5 to \$7 per lb for production quantities.

9.3.3 Status of development

A number of uncertainties remain, none of which particularly affect the viability of the molten-salt breeder concept. These uncertainties may effect further compromises in design and perhaps economics, but in no case are they vital to the technical or economic use of graphite in the reactor. These uncertainties appear to be resolvable by further work on graphite development.

9.3.3.1 Irradiation damage and graphite fabrication

The potential for developing improved graphites that can be employed by MSBR's at fluence levels beyond 3.5×10^{22} is high. A question remains concerning the degree of improvement to be anticipated. Confidence that at least incremental improvements can be made has increased significantly with improved understanding of the relationships between micro-structure and irradiation damage. The availability of HFIR (or fast reactors in the future) in which fluences can be attained in less than a year that are equivalent to those for an MSBR after several years enables a graphite development program to proceed at a reasonable rate.

The graphite fabrication process which is currently being studied at ORNL has been explored only briefly. Areas awaiting examination where further progress can be anticipated involve the use of blacks in processes analogous to the green-coke route, and the use of high-pressure processing for both raw materials and carbonization. To date very little effort has been expended by industry and other government laboratories toward increasing the life or stability of graphite, and the development of new processes, and diagnostic techniques suggest that much more rapid progress can be made. The alternate fabrication techniques and their relevance to damage resistance can be at least indicated within two or three years

after work is initiated. The fact that pyrolytic materials have survived to fluences greater than 1.5×10^{22} neutrons/cm² implies that lifetimes of the order of 5×10^{22} neutrons/cm² at 700°C should be attainable.

9.3.3.2 Xenon control

The ability to exclude xenon from graphite in the MSBR core by means of pyrolytic graphite impregnation or coating has not been demonstrated. Alternative sealing techniques exist but currently remain unexplored.

Both coatings and substrates have been shown separately to survive to fluence values greater than 3×10^{22} . Hence, this is strong reason to believe that a coating will be satisfactory for the MSBR. However, in the gas-cooled reactor program, where coatings have been shown to survive equivalent fluences, it has been found necessary to decouple the substrate and coating. Both low density pyrolytic and silicon carbide intercoatings have been employed, and analogous techniques could possibly be utilized here. If such techniques are required, a period of two to three years would be needed for their development. In any event, further work to scaleup sealing methods and prepare for transition to commercial suppliers will be required.

Two alternate sealing techniques involve filling the porosity in the graphite with liquid or solid salt. Uncertainty remains as to whether the diffusivity of xenon in the liquid or solid is sufficiently low and whether uranium transfers rapidly between the fuel salt and the impregnant salt. The potential of this approach could be determined in about one year.

Underlying all of the work on graphite sealing are questions related to the rate at which xenon will be transported into the graphite quite independent of its permeability. For example, the current uncertainty in the mass transfer coefficient between the fuel salt and helium bubbles allows the possibility that unsealed graphite may be acceptable. Information on this and other factors affecting xenon removal will be studied in an existing facility (Gas Systems Technology Facility) that is full scale for a 150-MW(t) MSR (see Section 10).

9.3.3.3 Thermal conductivity

The degradation of thermal conductivity with increasing fluence level remains to be established, and this leaves uncertain the maximum cross-sectional area of graphite prisms that will be acceptable in an MSBR. Although representing only a question of design, it must be answered.

9.3.3.4 Stresses and creep

Present knowledge on creep in graphite leads to an analysis indicating that only trivial stresses are developed in the graphite. Recent unpublished results obtained at Hanford may indicate that the ability of graphite to creep deteriorates at high fluences. If so, the problem can likely be avoided by changes in design, but the situation is uncertain and requires additional study.

9.3.3.5 General evaluation

In general, graphite presents no serious problem to the molten-salt breeder reactor. At least one vendor can supply a satisfactory material in the required sizes, and there is every reason to believe the lifetime of future graphites can be extended to perhaps twice that of the best existing materials. Cost estimates utilizing present material capabilities yield 0.17 mill/kWhr for replacement of the entire core on a four-year cycle in the reference design, or a somewhat lower cost if only the most highly irradiated material is replaced. Increasing the lifetime to eight years reduces the contribution to fuel cycle cost by about 0.1 mill/kWhr. Thus, existing base graphites are acceptable, and future graphites can probably be developed to reduce replacement costs.

The present methods for pyrolytically coating graphite appear promising. Alternative routes exist, but the question is eventually one of economics -- the value of marginal increases in breeding gain versus the cost of the coated material.

Sufficient data on the thermal and mechanical properties of graphites of the type required for the MSBR have not been obtained in the un-irradiated and irradiated conditions. Enough is known to be certain that mechanical properties do not affect the exact shapes of graphite permitted nor the means by which the graphite is supported, but additional data must be secured for design purposes.

9.4 TASK GROUP 8.1 BASIC GRAPHITE STUDIES

These studies will be concerned with determining basic radiation damage mechanisms in graphite. Single crystals will be used to determine the types and numbers of defects produced by irradiation. Annealing kinetics will be observed by transmission electromicroscopy.

9.4.1 Objective

The objective of this task will be to determine the basic mechanisms of radiation damage and annealing for graphite.

9.4.2 Schedule

The schedule for work in this task group is shown in Table 9.4.2.

9.4.3 Funding

Operating fund requirements for this task group are shown in Table 9.4.3.1, and capital equipment fund requirements are shown in Table 9.4.3.2.

9.4.4 Facilities

The task will make use of electronmicroscopes in the Metals and Ceramics and Solid State Divisions. Neutron irradiation experiments will be carried out in the ORR and HFIR.

9.4.5 Task 8.1.1 Irradiation damage and annealing in graphite single crystals

High purity single crystals of graphite will be irradiated with electrons in an electron microscope. The number and morphology of the defects will be determined at various temperatures. Some of the "damaged" samples will be held at temperature and the annealing of defects observed. This work should result in an accurate value for the energy required to displace a carbon atom from the graphite lattice. Quantitative information should be obtained about irradiation damage and annealing in graphite single crystals.

Impurities are known to be important in stabilizing irradiation-produced defects in graphite. Impurities will be added to graphite single crystals and their effects on damage and annealing kinetics determined.

9.4.6 Task 8.1.2 Irradiation damage and annealing in polycrystalline graphite

The presence of grain boundaries in graphite complicates irradiation damage mechanisms over those occurring in single crystals. The boundary serves as both source and sink for defects and as a surface to stabilize planar defects. It is anticipated that grain size and the angular mismatch between adjacent grains will be important variables and a systematic study will be made of their influence.

9.5 TASK GROUP 8.2 GRAPHITE BASE STOCK DEVELOPMENT

Work in this task group will involve a study of the basic raw materials and fabrication processes used in making graphite. Commercial and experimental graphites will be characterized, irradiated, and dimensional

Table 9.4.2. Schedule for work in Task Group 8.1 — Basic graphite studies

	Fiscal year					
	1976	1977	1978	1979	1980	1981
8.1.1 Irradiation damage and annealing in graphite single crystals						
8.1.2 Irradiation damage and annealing in polycrystalline graphite						

Table 9.4.3.1. Operating cost requirements for Task Group 8.1 — Basic graphite studies
(costs in 1000 dollars)

	Fiscal year					
	1976	1977	1978	1979	1980	1981
8.1.1 Irradiation damage and annealing in graphite single crystals		50	25	50	100	
8.1.2 Irradiation damage and annealing in poly- crystalline graphite			25	50	100	
Total operating funds for Task Group 8.1		50	50	100	200	

Table 9.4.3.2. Capital equipment fund requirements for Task Group 8.1 —
(costs in 1000 dollars)

	Fiscal year				
	1976	1977	1978	1979	1980
8.1.1 Irradiation damage and annealing in graphite single crystals		50	25		
8.1.2 Irradiation damage and annealing in poly- crystalline graphite			50	25	
Total capital equipment funds for Task Group 8.1		50	75	25	

and physical property changes measured. The goal will be to correlate starting material and fabrication variables with dimensional stability during irradiation.

9.5.1 Objective

The objective of this task group is to identify and characterize the most desirable graphites for MSBR use.

9.5.2 Schedule

The schedule for work in this task group is shown in Table 9.5.2.

9.5.3 Funding

Operating fund requirements for this task group are shown in Table 9.5.3.1, and capital equipment fund requirements are shown in Table 9.5.3.2.

9.5.4 Facilities

This task group will make use of several laboratories in Bldg. 4508 and some of the graphite fabrication equipment located in Bldg. 9202, Y-12. Experiments will be irradiated in HFIR and disassembled in the hot cells in Bldg. 3026D.

9.5.5 Task 8.2.1 Evaluation of commercial graphites

Numerous grades of graphite are made commercially in the US and foreign countries. Research quantities of the more desirable materials will be procured and evaluated. Evaluation will include measuring several physical properties such as pore size spectrum, gas permeability, crystalline anisotropy, density, electrical conductivity, and coefficient of thermal expansion in the unirradiated condition. The most attractive materials will be irradiated and the dimensional changes observed as a function of fluence.

9.5.5.1 Subtask 8.2.1.1 Vendor liaison and procurement

The manufacture of graphite is a highly specialized and proprietary operation. Continued liaison with the commercial vendors is required to keep them knowledgeable and interested in the MSR Program needs. In some cases, graphites of potential use are currently in production. In other cases vendors can modify an existing formulation or fabrication process to obtain a graphite useful for MSBR applications. Quite often a commercial graphite will be of interest primarily because of the raw

Table 9.5.2. Schedule for work in Task Group 8.2 -- Graphite base stock development

	Fiscal year											
	1976	1977	1978	1979	1980	1981	1982	1983	1984	1985	1986	
8.2.1 Evaluation of commercial graphites												
8.2.1.1 Vendor liason and procurement												
8.2.1.2 Characterization of commercial graphites												
8.2.1.3 Irradiation of commercial graphites												
8.2.2 Development and evaluation of experimental graphites												
8.2.2.1 Choice of raw materials												
8.2.2.2 Study of fabrication processes												
8.2.2.3 Characterization of experimental graphites												
8.2.2.4 Irradiation of experimental graphites												

Table 9.5.3.1. Operating fund requirements for Task Group 8.2 - Graphite base stock development

	Fiscal year										
	1976	1977	1978	1979	1980	1981	1982	1983	1984	1985	1986
8.2.1 Evaluation of commercial graphites											
8.2.1.1 Vendor liason and procurement	25	25	30	30	30	30	30	30	30	30	
8.2.1.2 Characterization of commercial graphites	40	40	50	50	50	50	50	50	50	50	
8.2.1.3 Irradiation of commercial graphites	65	65	70	70	75	75	75	75	75	75	
Subtotal 8.2.1	130	130	150	150	155	155	155	155	155	155	
8.2.2 Development and evaluation of experimental graphites											
8.2.2.1 Choice of raw materials					50	50	50	50	50	50	
8.2.2.2 Study of fabrication processes					100	100	100	100	100	100	
8.2.2.3 Characterization of experimental graphites					40	40	40	40	40	40	
8.2.2.4 Irradiation of experimental graphites					100	100	100	100	100	100	
Subtotal 8.2.2					290	290	290	290	290	290	
Total operating funds for Task Group 8.2	130	130	150	150	445	445	445	445	445	445	

Table 9.5.3.2. Capital equipment fund requirements for Task Group 8.2 — Graphite base stock development
(costs in 1000 dollars)

	Fiscal year											
	1975	1976	1977	1978	1979	1980	1981	1982	1983	1984	1985	1986
8.2.1 Evaluation of commercial graphites												
8.2.1.1 Vendor liaison and procurement		20	20	25	35	20	10	10	10	10	10	
8.2.1.2 Characterization of commercial graphites			10	10	10		10		10			
Subtotal 8.2.1		20	30	35	45	20	20	10	20	10	10	
8.2.2 Development and evaluation of experimental graphites												
8.2.2.2 Study of fabrication processes						100	100	100	20	20	20	
8.2.2.3 Characterization of experimental graphites						10	10	10	10	10	10	
8.2.2.4 Irradiation of experimental graphites						10	10	10	10	10	10	
Subtotal 8.2.2						120	120	120	40	40	40	
Total capital equipment funds for Task group 8.2		20	30	35	45	140	140	130	60	50	50	

material used or because of the fabrication process used. Research quantities of numerous products will be procured for evaluation in Subtasks 8.2.1.2 and 8.2.1.3.

9.5.5.2 Subtask 8.2.1.2 Characterization of commercial graphites

The commercial graphites obtained in Subtask 8.2.1.1 will be subjected to several characterization tests in the unirradiated condition including pore size spectrum, gas permeability, crystalline anisotropy, density, electrical conductivity, and coefficient of thermal expansion. Some graphites will likely be excluded from further testing by these results. For materials that are carried further, test results will serve as baseline information.

9.5.5.3 Subtask 8.2.1.3 Irradiation of commercial graphites

The graphites used for irradiation tests will be chosen on the basis of attractive properties as indicated by work in Subtask 8.2.1.2 or because they involve raw materials or fabrication processes of interest. Small cylindrical samples will be machined for irradiation in HFIR. The samples will be removed periodically for dimensional measurements. Some samples will be subjected to measurements such as density and pore spectrum as the irradiation schedule proceeds. The range of experimental variables will include temperatures of 500 to 800°C and fast fluences up to 3.5×10^{22} neutrons/cm².

9.5.6 Task 8.2.2 Development and evaluation of experimental graphites

Previous studies have given encouragement that graphites with improved dimensional stability can be developed. There is little financial incentive at this time for commercial graphite fabricators to develop such a product, and the work will be pursued by the MSR Program. Research quantities of graphite will be produced using well-characterized materials and processes. Samples will be carried through evaluation steps similar to those described for Task 8.2.1.

9.5.6.1 Subtask 8.2.2.1 Choice of raw materials

Several types of raw materials are used in fabricating graphite. Some of these materials are highly graphitic (crystalline) and others are almost amorphous. The less-graphitic materials were once thought to adversely affect irradiation behavior, but recent studies indicate that this is not the case under MSBR conditions. The combined use of highly graphitic and amorphous materials appears attractive. The integrity of the binder material is very important and it appears that the so-called "binderless graphites" may be more resistant to loss of cohesion or cracking between individual graphite particles. However, the "binderless graphites" undergo large dimensional changes during fabrication, and

techniques must be developed for accommodating these changes. The choice of raw materials will also be based on information from Subtasks 8.2.2.2 through 8.2.2.4.

9.5.6.2 Subtask 8.2.2.2 Study of fabrication processes

Forward extrusion, molding, and forward extrusion with back pressure are the most common methods used for final graphite forming. However, the entire process flowsheet involves a myriad of heating, mixing, crushing, and sizing steps. One of the key factors appears to be the choice of these processing variables such that the finished product is isotropic on the smallest scale possible. That is, graphite which is isotropic on the basis of relatively large particles has inferior dimensional stability to that which is isotropic on the basis of the small crystallites within the particles. This subtask will be involved with study of the entire fabrication flowsheet, and its function will be to supply material for the following two subtasks.

9.5.6.3 Subtask 8.2.2.3 Characterization of experimental graphites

The graphites produced in the above subtask will be subjected to a progression of evaluation tests. The first tests will be involved only with assessing structural integrity. The subsequent tests will involve determination of bulk density, pore size spectrum, and crystalline anisotropy. Additional tests such as coefficient of thermal expansion, electrical conductivity, and gas permeability may be run on some of the best grades. This information will be used in Subtasks 8.2.2.1 and 8.2.2.2. The more attractive materials will be tested further in Subtask 8.2.2.4.

9.5.6.4 Subtask 8.2.2.4 Irradiation of experimental graphites

The graphites for irradiation will be chosen on the basis of attractive properties as indicated by the tests in Subtask 8.2.2.3 or because they involve raw materials or fabrication processes of interest. Small cylindrical samples will be machined for irradiation in HFIR. The samples will be removed periodically for dimensional measurements. Some samples will be subjected to measurements including density and pore spectrum as the irradiation schedule proceeds. The range of experimental variables will include temperatures of 500 to 800°C and fast fluences up to 3.5×10^{22} neutrons/cm².

9.6 TASK GROUP 8.3 SEALING GRAPHITE TO REDUCE PERMEABILITY

The absorption of ¹³⁵Xe by the core graphite can result in a significant reduction in breeding performance. Most of the ¹³⁵Xe will be removed from the fuel salt by contact with helium bubbles, but it will likely be necessary to reduce the permeability of the graphite in order to prevent

the absorption of xenon. It is likely that graphite having surface permeabilities of about 10^{-8} cm²/sec will be required, and this low permeability can only be obtained by (a) impregnating the graphite with salt, (b) impregnating the graphite with carbon, or (c) surface coating the graphite with pyrocarbon. All of these techniques will be studied to some extent.

9.6.1 Objective

The objective of this task is to develop a process for decreasing the permeability of graphite moderator elements with respect to ¹³⁵Xe to acceptably low values (about 10^{-8} cm²/sec).

9.6.2 Schedule

The schedule for work in this task group is shown in Table 9.6.2.

9.6.3 Funding

Operating fund requirements for this task group are shown in Table 9.6.3.1, and capital equipment fund requirements are shown in Table 9.6.3.2.

9.6.4 Facilities

Several laboratories in Bldg. 4508 will be used for the development of sealing techniques. Samples will be irradiated in HFIR, removed from the experimental capsule in the hot cells in Bldg. 3026D, and returned to Bldg. 4508 for permeability measurements.

9.6.5 Task 8.3.1 Salt impregnation

Salt containing LiF and BeF₂ will be forced into graphite by gas overpressure. The permeability of helium through the impregnated graphite will be measured over the temperature range of 500 to 700°C. If the impregnated graphite has a suitably low helium permeability, tests will be carried out to determine the rate of transfer of uranium from a surrounding fuel salt into the impregnated graphite. Results from these two tests must be available before further work on this sealing technique can be planned.

9.6.6 Task 8.3.2 Carbon impregnation

Previous studies have shown that graphite can be sealed by impregnation with carbon deposited from a gaseous mixture. However, subsequent irradiation tests revealed that the useful lifetime of the graphite was

Table 9.6.2. Schedule for work in Task Group 8.3 - Sealing graphite to reduce permeability

	Fiscal year												
	1975	1976	1977	1978	1979	1980	1981	1982	1983	1984	1985	1986	
8.3.1 Salt impregnation													
8.3.2 Carbon impregnation													
8.3.3 Carbon coatings													

Table 9.6.3.1. Operating fund requirements for Task Group 8.3 — Sealing graphite to reduce permeability
(costs in 1000 dollars)

	Fiscal year												
	1975	1976	1977	1978	1979	1980	1981	1982	1983	1984	1985	1986	
8.3.1 Salt impregnation		40	40										
8.3.2 Carbon impregnation				64	75	75							
8.3.3 Carbon coatings		240	264	275	278	275	250	200	200	150	150		
Total operating funds for Task Group 8.3		290	304	339	353	350	250	200	200	150	150		

Table 9.6.3.2. Capital equipment fund requirements for Task Group 8.3 - Sealing graphite to reduce permeability (costs in 1000 dollars)

	Fiscal year											
	1975	1976	1977	1978	1979	1980	1981	1982	1983	1984	1985	1986
8.3.1 Salt impregnation		10	10									
8.3.2 Carbon impregnation				50								
8.3.3 Carbon coatings		10	25	50	20	100	20	20	100	20	20	
Total capital equipment funds for Task Group 8.3		20	35	100	20	100	20	20	100	20	20	

shortened by the presence of the impregnant. This technique can likely be used only if the penetration of the deposited carbon is very slight and the base graphite does not contract appreciably during irradiation. This technique for sealing graphite would be pursued at a very low level with variations in impregnation technique and base stock. Irradiation in HFIR with periodic gas permeability measurements will be the prime method of evaluation.

9.6.7 Task 8.3.3 Carbon coatings

Pyrocarbon coatings have been placed on graphite with moderate success. Dense impervious coatings can be formed, but their helium permeability increases during irradiation. Many of the failures were traced to flaws in the coating; hence, emphasis will be placed on developing coating techniques which minimize flaws. Only one graphite substrate was studied previously (POCO AXF), and other materials will be included in future studies. Samples will be irradiated in HFIR and removed periodically for permeability measurements.

The potential of using decoupled coatings will be studied. The first pyrocarbon layer will be of low density and easily deformable. The second layer will be of high density and impervious to xenon. Techniques will be developed for applying this type of coating, and coated samples will be irradiated. Evaluation will be made by periodic removal of the samples for permeability measurements.

Scaled-up coating techniques will be developed for the most attractive process. The coatings must ultimately be applied to moderator elements several feet long, and multiple injectors will be necessary for obtaining satisfactory coatings.

9.7 TASK GROUP 8.4 PHYSICAL PROPERTIES

The physical properties of graphite cover a wide range due to the large number of starting materials and fabrication techniques used in graphite manufacture. The physical properties provide useful information about the crystallographic structure and other properties. Similarly, the changes in physical properties during irradiation provide information about the crystallographic changes which occur. Thus, physical properties such as thermal expansion, thermal conductivity, and electrical resistivity are very useful for characterizing graphite and for evaluating structural changes during irradiation. The changes of these properties are also of direct importance to the design of a reactor core, since they affect dimensional behavior and heat transfer. A program will be carried on in which graphite samples are alternately irradiated and physical properties measured.

9.7.1 Objective

The objective of this task group is to determine how irradiation changes the physical properties of graphite.

9.7.2 Schedule

The schedule for work in this task group is shown in Table 9.7.2.

9.7.3 Funding

Operating fund requirements for this task group are given in Table 9.7.3.1 and capital equipment fund requirements are given in Table 9.7.3.2.

9.7.4 Facilities

This work will make use of the Physical Properties Laboratory in Bldg. 4508. Samples will be irradiated in HFIR, removed from the irradiation capsule in the hot cells in Bldg. 3026, and returned to Bldg. 4508 for postirradiation measurements.

9.7.5 Task 8.4.1 Thermal conductivity measurements

The thermal conductivity of the core graphite will have a direct bearing on the peak temperature in the graphite. The rate of dimensional change in graphite increases with increasing temperature, so the thermal conductivity and the allowable neutron fluence are related. Irradiation is known to decrease the thermal conductivity but this effect is thought to saturate at fluence values of about 10^{20} neutrons/cm². Equipment for making thermal conductivity measurements and irradiation capsules for exposing samples have been proven satisfactory. About three grades of graphite will be irradiated at 550, 650, and 750°C to fluences ranging from 1×10^{19} to 3.5×10^{22} neutrons/cm². The samples will be removed periodically for thermal conductivity measurements. A goal of this work will be to relate changes in thermal conductivity to some basic characteristic of the graphite such as the raw material used in its manufacture.

9.7.6 Task 8.4.2 Thermal expansion

The coefficient of thermal expansion is an indicator of the crystallographic structure. The differences in thermal expansion in different directions is a measure of the crystalline anisotropy. The magnitude of the thermal expansion is closely related to the raw material used in making the graphite. A number of theories dealing with radiation damage utilize the coefficient of thermal expansion to predict the

Table 9.7.2. Schedule for work in Task Group 8.4 - Physical properties

	Fiscal year												
	1975	1976	1977	1978	1979	1980	1981	1982	1983	1984	1985	1986	
8.4.1 Thermal conductivity measurements													
8.4.2 Thermal expansion													
8.4.3 Electrical conductivity													
8.4.4 Elastic properties													

Table 9.7.3.1. Operating fund requirements for Task Group 8.4 - Physical properties
(costs in 1000 dollars)

	Fiscal year											
	1975	1976	1977	1978	1979	1980	1981	1982	1983	1984	1985	1986
8.4.1 Thermal conductivity measurements		15	15	15	15	50	50	50	50	50	50	
8.4.2 Thermal expansion		10	5	10	10	25	25	25	25	25	25	
8.4.3 Electrical conductivity		5	5	5	5	10	10	10	10	10	10	
8.4.4 Elastic properties			5	10	10	30	30	30	30	30	30	
Total operating funds for Task Group 8.4		30	30	40	40	115	115	115	115	115	115	

Table 9.7.3.2. Capital equipment fund requirements for Task Group 8.4 - Physical properties
(costs in 1000 dollars)

	Fiscal year											
	1975	1976	1977	1978	1979	1980	1981	1982	1983	1984	1985	1986
8.4.1 Thermal conductivity measurements		20		20		20		20		20		
8.4.2 Thermal expansion		20			20		20					10
8.4.4 Elastic properties			30		10				10			
Total capital equipment funds for Task Group 8.4		40	30	20	30	20	20	20	10	20	10	

dimensional changes that will occur during irradiation. The coefficient of thermal expansion is also a necessary parameter for design purposes.

Measuring equipment and irradiation techniques have been developed for incrementally following the thermal expansion of graphite during irradiation. Samples of three graphites will be measured, irradiated in HFIR, and removed periodically in order to repeat the measurements. (The same samples used in the above task will be used for these measurements.)

9.7.7 Task 8.4.3 Electrical conductivity

Electrical conductivity of graphite is a measure of the mobility of electrons through the material and is a rather basic parameter. This property is closely related to the thermal conductivity and the measuring techniques for thermal conductivity are such that electrical conductivity measurements can be obtained at the same time. Thus, the experimental plan described in Task 8.4.1 would be applicable to determination of electrical conductivity.

9.7.8 Task 8.4.4 Elastic properties

The elastic properties of graphite are used in numerous design calculations, the most important one being the magnitude of the stresses developed in the moderator elements due to differential dimensional changes across the element. The elastic properties are affected by irradiation and this variable will be included in the test program. Sonic methods will likely be used to measure the elastic constants. A sound wave is pulsed through a sample and the times for obtaining reflected waves in the transverse and longitudinal directions are measured. These data define the velocity of sound in the two directions, and these values can be used to calculate Young's and shear moduli. These two elastic constants allow calculation of all other elastic constants. The small cylindrical samples used in Task 8.2 and 8.3 would be used for these measurements. A key part of the measuring technique is not yet worked out which concerns the means of coupling a transducer to the sample for transmitting and receiving the sound pulse. The method currently in use would contaminate the sample and would prevent further irradiation of the sample.

9.8 TASK GROUP 8.5 EVALUATION TESTS FOR MSBR GRAPHITE

Several tests must be made on the grade of graphite chosen for the molten-salt test reactor and for the reference design MSBR. The work carried out in Task Groups 8.1 through 8.4 will have involved small samples. Tests of a proof nature will be run on large pieces having the full cross section of a moderator element. These tests will include long-term irradiation tests on uncoated and coated elements, and subsequent evaluation of the irradiated specimens.

9.8.1 Objective

The objective of this task will be to evaluate in detail the properties of large moderator elements.

9.8.2 Schedule

The schedule for work in this task group is shown in Table 9.8.2.

9.8.3 Funding

Operating fund requirements for this task group are shown in Table 9.8.3.1, and capital equipment fund requirements are shown in Table 9.8.3.2. This includes capital equipment funds in the amount of \$300,000 in both FY 1980 and FY 1981 for construction of two facilities for in-reactor irradiation of large moderator graphite sections.

9.8.4 Facilities

Facilities will be required for irradiation of large-scale prototypic moderator graphite elements, and two instrumented, in-reactor test facilities capable of independent temperature control will be constructed. Location of the facilities in the ORR, the HFIR, or a Savannah River reactor appears possible.

9.8.5 Task 8.5.1 Large-scale irradiation testing

The irradiation testing performed in other tasks has involved small test samples, however, some proof testing on large elements will be necessary. The main variable not evaluated by the small samples is fabrication inhomogeneities. Density gradients, variations in pore size distribution and other inhomogeneities can be present in large elements. Large elements that have been sealed to prevent xenon permeation can have areas in which the coating will vary in its dimensional stability during irradiation. These coating inhomogeneities could lead to earlier localized coating failures than predicted from data for small specimens.

9.8.5.1 Subtask 8.5.1.1 Base graphite

Graphite samples having the full cross section of an MSBR moderator element and about 2 ft long will be irradiated in the core of the ORR and likely some other reactor having a larger irradiation facility (e.g., a Savannah River reactor). It is likely that the experiments will be instrumented to obtain continuous data on dimensional changes. The experiments will likely be removed periodically for dimensional measurements and replacement of in-reactor instrumentation. These experiments will likely involve two to four elements of the reference graphite, will

Table 9.8.2. Schedule for work in Task Group 8.5 - Evaluation tests for MSBR graphite

	Fiscal year							
	1979	1980	1981	1982	1983	1984	1985	1986
8.5.1 Large scale irradiation testing								
8.5.1.1 Base graphite								
8.5.1.2 Coated elements								
8.5.2 Analytical evaluation of reference graphite								

Table 9.8.3.1. Operating fund requirements for Task Group 8.5 — Evaluation tests for MSBR graphite (costs in 1000 dollars)

	Fiscal year							
	1979	1980	1981	1982	1983	1984	1985	1986
8.5.1 Large scale irradiation testing								
8.5.1.1 Base graphite		100	200	200	200	200	100	
8.5.1.2 Coated elements			200	200	200	200	200	
Subtotal 8.5.1		100	400	400	400	400	300	
8.5.2 Analytical evaluation of reference graphite			75	100	100	100	100	
Total operating funds for Task Group 8.5		100	475	500	500	500	400	

Table 9.8.3.2. Capital equipment fund requirements for Task Group 8.5 — Evaluation tests for MSBR graphite (costs in 1000 dollars)

	Fiscal year							
	1979	1980	1981	1982	1983	1984	1985	1986
8.5.1 Large scale irradiation testing		300	300					
8.5.1.1 Base graphite		70	20	20	20	20	20	
8.5.1.2 Coated elements			70	20	20	20	20	
Total capital equipment funds for Task Group 8.5		370	390	40	40	40	40	

be exposed over the temperature range of 500 to 750°C, and will be irradiated to a fluence of about 3×10^{22} neutrons/cm² over a period of several years.

9.8.5.2 Subtask 8.5.1.2 Coated elements

Samples of the reference graphite will be coated by the most promising techniques and irradiated in the same type of experiment as described in Subtask 8.5.1.1. The specimens will have the full cross section of a moderator element and will be at least 1-ft long. They will also contain a small center annulus with lines for collecting and analyzing the gas from this annulus. The permeability will be determined in situ from the knowledge of the geometry, the pressure differential, and the rate of ingress of gas into the inner annulus. These experiments will run for several years to fluences of 3.5×10^{22} neutrons/cm².

Since the permeability measurements will be made in situ, the experiments will be removed only after the permeability becomes too high for the experiment to be of interest or when the instrumentation must be replaced.

9.8.6 Task 8.5.2 Analytical evaluation of reference graphite

The large-scale irradiation experiments in Task 8.5.1 will provide data of unique value for analytically analyzing the performance of graphite in a reactor. The ability of graphite to creep under irradiation is required to relax stresses that develop due to anisotropic dimensional changes. The elements in these experiments will experience anisotropic dimensional changes and the demonstrated ability of the graphite to accommodate these dimensional changes while remaining integral will be of extreme value. The demonstrated lifetime of the coatings will allow a realistic assessment of the economics of graphite replacement at a given fluence versus continued operation at a lower performance. The information obtained from these experiments will be analyzed with regard to performance and made available for use in reactor design and analysis (Section 8).

REFERENCES FOR SECTION 9

1. H. E. McCoy and B. McNabb, "Postirradiation Examination of Materials from the MSRE," ORNL-TM-4174 (1972).
2. G. B. Engle and W. P. Eatherly, "A Review of High-Temperature Graphite Irradiation Behavior" in High Temperature-High Pressures (to be published).
3. J. M. W. Simmons, *Radiation Damage in Graphite*, Pergamon Press (1965).
4. *Conceptual Design Study of a Single Fluid Molten-Salt Reactor*, ORNL-4528 (1970).
5. "1000 Mw(e) Molten-Salt Breeder Reactor Conceptual Design Study," Final Report - Task I, Ebasco Services, Inc. (1971).
6. E. S. Bettis, L. G. Alexander, and H. L. Watts, *Design Studies of a Molten-Salt Reactor Demonstration Plant*, ORNL-TM-3832 (1972).
7. D. Scott and W. P. Eatherly, *Nucl. Appl. Tech.* 8: 179 (1970).
8. W. P. Eatherly et al., *Technical Analysis and Program Proposal: Graphite for Molten-Salt Reactors*, ORNL-CF-68-11-18 (1968).
9. *MSR Program Semiannu. Progr. Rept. Aug. 31, 1971*, ORNL-4728.
10. *MSR Program Semiannu. Progr. Rept. Aug. 31, 1969*, ORNL-4449.
11. *MSR Program Semiannu. Progr. Rept. Feb. 28, 1971*, ORNL-4676.
12. *MSR Program Semiannu. Progr. Rept. Feb. 28, 1969*, ORNL-4396.
13. *MSR Program Semiannu. Progr. Rept. Aug. 31, 1970*, ORNL-4622.
14. *MSR Program Semiannu. Progr. Rept. Feb. 29, 1972*, ORNL-4782.

10. REACTOR TECHNOLOGY DEVELOPMENT

10.1 INTRODUCTION

10.1.1 Objective

The objective of this activity is development of the technology necessary for designing and specifying the performance of components and systems which would constitute molten-salt reactors including a test reactor, a demonstration reactor, and a 1000-MW(e) MSBR.

10.1.2 Scope

This activity covers all development work associated with reactor systems and components except for that dealing with fuel processing and instrumentation development, which are covered in Sections 3 and 12, respectively. In general, determination of basic physical properties of salts and the development of materials of construction fall outside this activity; however, some information of this type will result from work in this activity.

Although the requirements for components and systems will be specified largely by conceptual design studies for the various molten-salt reactors considered in the activity Reactor Design and Analysis (Section 8), additional conceptual design studies would be carried out as necessary for identifying problem areas in proposed component designs and for properly orienting the component technology development.

In general, work in this activity proceeds from small equipment, which may involve tests with aqueous solutions rather than molten-salt, through successively larger equipment sizes and culminates in tests using molten salt on a scale sufficiently large to allow detailed component design for test and demonstration reactors.

After operation of the molten-salt test reactor (see Section 14) and test reactor mockup (see Section 13), additional development work will be required to scale up equipment which functioned satisfactorily, to develop items the need for which is not now known, and to make improvements required for a demonstration reactor. This work is covered in Section 15.

In all of the development activities, industrial participation through government-sponsored subcontracts as well as industry-sponsored work will be solicited and encouraged. All large components will be purchased from logical vendors, if available, in order to establish a source for future reactor components.

The work associated with this activity area is divided into the following task groups:

Fuel Salt Technology Development (Task Group 9.1)
Coolant Salt Technology Development (Task Group 9.2)
Steam System Technology Development (Task Group 9.3)
Cover and Off-Gas Systems Technology Development (Task Group 9.4)
Salt Pump Development (Task Group 9.5)
Primary Salt-Salt Heat Exchanger Development (Task Group 9.6)
Valve Development (Task Group 9.7)
Control Rod Development (Task Group 9.8)
Containment and Cell Heating Development (Task Group 9.9)
Components Test Facility (Task Group 9.10)

10.1.3 Relation to other activity areas

There is a close relationship between all activity areas in this program plan, and careful coordination of the work is necessary. In many cases the need for reactor technology development may originate in other activity areas and, conversely, the reactor development activities may dictate additional work elsewhere, such as chemical research or safety analysis. Much of the instrumentation and controls development (Section 12) as well as the maintenance procedures (Section 11) will be governed by the results of reactor technology development work. Especially close contact will be maintained with the activities on reactor design and analysis and on reactor safety.

10.2 BUDGET AND SCHEDULE

10.2.1 Schedule

The work in the Molten-Salt Reactor Program in the near future will be of a technology nature; and, during this period, work in the Reactor Technology Development area will be concerned mainly with development and testing in the Gas-System Technology Facility, which circulates fuel salt and in the Coolant-Salt Technology Facility, which circulates coolant salt. Work in these facilities will be phased out during the period FY 1977 to 1981. Other small-scale development of components and systems will begin in the period FY 1977 to 1979, using small separate facilities. Larger-scale component development will be done in the Components Test Facility which will be completed during FY 1982.

The steam generator and salt pump development activities appear to be critical path items, and work on these components will be carried out as rapidly as funds allow. Some steam generator studies will be done during FY 1975, with the work effort increasing rapidly in order to effect the timely development of technology required for design of a molten-salt test reactor. Salt pump procurement activities will begin in FY 1978, which should allow testing of an MSTR prototype pump to begin in FY 1983.

The schedule for work on reactor technology development is shown in Table 10.2.1.

Table 10.2.1. Schedule for work on reactor technology development

	Fiscal year											
	1975	1976	1977	1978	1979	1980	1981	1982	1983	1984	1985	1986
9.1 Fuel salt technology		▽ ¹		▽ ²		▽ ³						
9.2 Coolant salt technology				▽ ^{1,2}							▽ ³	
9.3 Steam system technology		▽ ¹	▽ ²			▽ ³	▽ ⁴		▽ ⁵	▽ ⁶		
9.4 Cover- and off-gas systems technology								▽ ¹			▽ ²	
9.5 Salt pump development								▽ ¹		▽ ²		
9.6 Primary heat exchanger development									▽ ¹			
9.7 Valve development						▽ ¹					▽ ²	
9.8 Control rod development												▽ ¹
9.9 Containment and cell heating development									▽ ¹			▽ ²
9.10 Components Test Facility						▽ ¹		▽ ²				

10.2.2 Funding

Operating fund requirements for work on reactor technology development are shown in Table 10.2.2.1, and capital equipment fund requirements are shown in Table 10.2.2.2.

Large capital appropriations are required in FY 1979 for the Steam Generator Tube Test Stand (\$4 million), in FY 1980 for the Pump Test Stand (\$1 million) and the Components Test Facility (\$10 million), and in FY 1981 for the Model Steam Generator Test Installation (\$20 million).

10.2.3 Key milestones

The milestones in this activity area are listed below by respective task group and are indicated by corresponding numbers in Fig. 10.2.1.

10.2.3.1 Task Group 9.1 Fuel salt technology development

1. The Gas-Systems Technology Facility water tests will be finished and construction completed so that salt operation can start early in FY 1976.
2. By the end of FY 1977 sufficient tests will have been completed to indicate that the efficiency of the bubble generator-bubble separator is satisfactory and that mass transfer rates are adequate to permit detailed design of the xenon removal system for a molten-salt test reactor. Additional development will be done to refine the results and test the effects of other variables.
3. All problems pertaining to the behavior of tritium in the fuel-salt system will be resolved by FY 1980.

10.2.3.2 Task Group 9.2 Coolant salt technology development

1. Tests for determining the behavior of tritium in the coolant system will be completed by the end of FY 1977.
2. Corrosion product removal studies will be completed by the end of FY 1977.
3. Large-scale demonstration tests of coolant salt technology should be completed by the end of FY 1984.

10.2.3.3 Task Group 9.3 Steam system technology development

1. The feasibility of using lower feedwater temperatures will be determined by the middle of FY 1976. This may affect the subsequent design and development of the steam-system components.

Table 10.2.2.1. Operating fund requirements for work on reactor technology development
(costs in 1000 dollars)

	Fiscal year											
	1975	1976	1977	1978	1979	1980	1981	1982	1983	1984	1985	1986
9.1 Fuel salt technology	185	230	230	160	250	440	200	150	250	200		
9.2 Coolant salt technology	169	290	100					100	200	200		
9.3 Steam system technology	56	280	580	600	810	1090	1250	1200	1200	1200	1200	
9.4 Cover- and off-gas system technology			60	120	60	80	180	110	40	40		
9.5 Salt pump development				40	140	625	1565	1225	1075	300	300	
9.6 Primary heat exchanger development							80	50	100			
9.7 Valve development				40	100	100	100	100	100	200		
9.8 Control rod development							60	60	60	150	150	
9.9 Containment and cell heating development						60	100	60		100	50	
9.10 Components test facility				120	80	200	200	445	725	1610	2300	
Total operating funds for reactor technology development	410	800	970	1080	1440	2595	3735	3500	3750	4000	4000	

Table 10.2.2.2. Capital equipment fund requirements for work on reactor technology development
(costs in 1000 dollars)

	Fiscal year										
	1975	1976	1977	1978	1979	1980	1981	1982	1983	1984	1985
9.1 Fuel salt technology	28	66				50		50	60		
9.2 Coolant salt technology											
9.3 Steam system technology			35	20					200	250	
9.4 Cover- and off-gas system technology				40							
9.5 Salt pump development						20					
9.6 Primary heat exchanger development								50			
9.7 Valve development					250						
9.8 Control rod development								250			
9.9 Containment and cell heating development							77				
9.10 Components Test Facility								75	411	579	1023
Total capital equipment funds for reactor technology development	28	66	35	60	290	70	77	425	671	829	1023

2. By the end of FY 1976, the industrial recommendation for a steam generator research and development program should be completed.
3. By the end of FY 1979, the small-scale steam generator work should have progressed to a stage which will permit reevaluation of the research and development program.
4. The construction of the Steam Generator Tube Test Stand, pressure relief system, and the 3-MW test assembly should be complete by the middle of FY 1981.
5. Testing in the Steam Generator Tube Test Stand should be finished by mid FY 1983.
6. Construction of the Steam Generator Model Test Installation, the pressure relief system, and the 30-MW model steam generator should be complete by the end of 1983, and operational tests will be started.

10.2.3.4 Task Group 9.4 Cover and off-gas systems technology development

1. Development of methods for handling gaseous effluents (including fission products, tritium, and BF_3) from the off-gas systems should be complete by the end of FY 1982.
2. All other problems associated with the cover and off-gas systems should be resolved by the end of FY 1984.

10.2.3.5 Task Group 9.5 Salt pump development

1. The design of the MSTR prototype pump and pump test stand should be complete by the end of FY 1981.
2. The construction of the MSTR prototype pump and pump test stand should be completed by the end of FY 1983, and operational tests will be started.

10.2.3.6 Task Group 9.6 Primary salt-salt heat exchanger development

1. All development work on the primary heat exchanger preparatory to design of the MSTR will be completed by the end of FY 1983.

10.2.3.7 Task Group 9.7 Valve development

1. Preliminary valve development needed to proceed with design of the MSTR will be finished by the end of FY 1979.
2. Final development of specific valves for the MSTR will be finished by the end of FY 1984.

10.2.3.8 Task Group 9.8 Control rod development

1. All development needed for the MSTR control rods will be completed by the end of FY 1985.

10.2.3.9 Task Group 9.9 Containment and cell heating

1. Exploratory studies and preliminary development needed for the design of the MSTR containment and cell heating should be completed by the end of FY 1982.
2. Testing of the containment and cell heating design for the MSTR should be completed by the end of FY 1985.

10.2.3.10 Task Group 9.10 Components Test Facility

1. The design of the Components Test Facility should be sufficiently complete to start construction in mid FY 1980.
2. Construction of the Components Test Facility should be completed by the middle of FY 1982.

10.3 EXPERIENCE AND STATUS OF DEVELOPMENT

10.3.1 Fuel salt technology development

The MSRE was operated from 1964 to 1969 using a fuel salt similar to that proposed for the MSBR. When it was shut down in December of 1969, the reactor had accumulated 13,172 full-power hours of operation and salt had been circulated in the fuel system for 21,788 hours.¹

Although the MSRE was operated successfully using a fuel salt containing ^{235}U and later ^{233}U , there are some significant differences relative to the MSBR fuel salt which require additional study. The MSRE salt contained about 5 mole % ZrF_4 for preventing UO_2 precipitation, whereas the MSBR salt does not contain ZrF_4 . The proposed operating temperature and power density of the MSBR are higher and the method for removing gaseous fission products is somewhat more complicated. These differences, together with other uncertainties, dictate a number of developmental tasks associated with the fuel salt system.

In a reactor which operates in the thermal energy range, continuous removal of the gaseous fission product, xenon-135, is necessary to obtain a breeding ratio greater than 1.0. In a molten-salt breeder reactor (MSBR), the xenon-135 circulates in solution with the molten fluoride fuel salt, and the proposed xenon removal method consists of circulating a low volume fraction (0.2 to 1% at core midplane) of helium bubbles with the salt to serve as a sparging agent. The xenon-135 and other gaseous fission products would transfer from the salt to the helium bubbles by turbulent diffusion and would be stripped from the salt-bubble mixture when the bubbles are removed. Calculations, based on currently available information, have shown that stripping the bubbles from a 10% side stream would reduce the xenon poisoning to an acceptable level and that little advantage would be gained by stripping larger streams. Supplementary iodine stripping would be needed only if satisfactory methods cannot be developed for sealing the core graphite with respect to xenon permeation. Work on xenon stripping has been concentrated on the development and aqueous testing of in-line bubble generators² and bubble separators.³ Based on tests of various bubble generator types under different operating conditions and using different aqueous solutions, a venturi-type generator was selected for further testing in salt. The bubble size produced by the bubble generator is believed to have a minor influence on the overall operation of a xenon removal system because of bubble degradation and compression during passage of the bubbles through the primary pump and other changes in bubble size that may occur because of coalescence, gas solubility, and pressure changes.

Tests of bubble separators have been conducted using demineralized water and two modeling fluids, a 41% glycerin-water mixture and a 31% aqueous calcium chloride solution, both having kinematic viscosities equivalent to MSBR fuel salt at 1225°F. These tests would be conservative in regard to bubble separation efficiency at higher salt temperatures. The bubble diameters at the bubble separator inlet using the test fluids were about 0.001 to 0.005 in. as compared with about 0.020 in. in demineralized water. Since the bubble size characteristics in a molten-salt system were unknown at the time, development tests were continued with the small bubbles associated with the CaCl₂ solution rather than searching for a suitable fluid having bubble sizes more nearly equivalent to those observed with water. Based on these tests, an axial-flow, centrifugal-type bubble separator was designed for testing in the Gas-Systems Technology Facility. CaCl₂ solution tests on this design showed bubble separation efficiencies of greater than 80% under normal operating conditions. Based on a bench-scale comparison test of bubble formation and coalescence, a higher separation efficiency is expected with molten salt. Bubble size determination would aid in further separator evaluation; however, instrumentation of this type does not appear to be available.

Very little quantitative information is available regarding the distribution of tritium in MSR systems. The amount of tritium that could reach the steam system of the reference design MSBR is estimated to be about one-third of the 2420 Ci/day production rate in the fuel.⁴ Tests made shortly before the MSRE was shut down indicate that about half of

the tritium was discharged from the fuel off-system.⁵ Less than 10% diffused through the metal walls of the fuel system to the containment-cell atmosphere, and less than 10% reached the air through the heat removal system. More quantitative information regarding tritium behavior in large molten-salt systems is needed.

The fission process is mildly oxidizing toward dissolved U^{3+} in the fuel. At the MSRE, beryllium metal was dissolved in the fuel salt periodically in order to adjust the redox potential of the salt, and some changes in the physical properties of the fuel salt were noted at these times. Since such changes could affect the efficiency of the bubble generator, further studies of the variation of physical properties of the salt with redox potential and their significance with respect to xenon removal are needed.

Fissile material inventory and system corrosion rates will be indicated by analysis of the fuel salt. On-line analytical devices will be developed for this application as outlined in Section 6. In addition, it will be necessary to perform selected chemical analyses in a hot cell laboratory. Obtaining a sample and delivering it to the laboratory requires careful manipulation to prevent altering the salt chemistry. In addition, adequate containment must be maintained. The experience with the MSRE sampler,⁷ which functioned well during the entire period of operation, will be utilized in developing samplers for future molten-salt reactors.

The after-heat removal system for the MSBR utilizes the fuel drain tank and a natural-circulation NaK cooling system. Heat is transferred from the salt through an air gap to tubes through which NaK circulates. The MSRE drain tanks were equipped with similar cooling tubes having an air gap; however, boiling water was used as the cooling medium. The predicted heat transfer rates for this system were verified⁷ but no information was obtained on system service life.

10.3.2 Coolant salt technology development

Molten-salt breeder reactor systems require the circulation of an intermediate coolant to (1) provide a barrier for protecting the steam system from fission product contamination and for protecting the fuel system from steam-system pressures, (2) transfer the nuclear heat from the fuel salt to the water-steam system, and (3) bridge the temperature interval between the fuel salt liquidus temperature and the steam system feed water temperature.

A mixture of $LiF-BeF_2$ (66-34 mole %) was used successfully as the coolant in the secondary system of the MSRE, but its high liquidus temperature (875°F) and high cost (\$600 to \$1400/ft³) prompted a search for other possible coolants.²⁷ Of the alternates considered, the sodium fluoroborate eutectic, $NaBF_4-NaF$ (92-8 mole %), appears to be the most promising. It has a relatively low melting point (725°F) and cost (\$60/ft³),

and there is a possibility that it can aid in preventing transport of tritium to the steam system by interaction with the tritium. Among its disadvantages are (1) the need for BF_3 in the cover gas because of the evolution of BF_3 from NaBF_4 at MSBR operating temperatures, and (2) the corrosiveness of fluoroborate in the presence of water.

10.3.2.1 Experience

Sodium fluoroborate eutectic salt has been circulated for tens of thousands of hours in natural- and forced-convection loops constructed of Hastelloy N to obtain data on corrosion, mass transfer, and materials compatibility.

In addition, an MSRE-scale pump loop (PKP-1) constructed of 4-in.-diam Inconel pipe was operated with a flow rate of 750 gpm at 800 to 1000°F for over 11,000 hr to obtain experience with both the salt and the BF_3 -helium cover gas system required for salt composition control.²⁸ Because the configuration of the PKP-1 loop was not suitable for conducting the additional required experiments and the material of construction was atypical of current and proposed molten-salt reactors, an all Hastelloy N loop was designed and constructed using the pump and piping salvaged from the secondary coolant system of the MSRE. This loop, known as the Coolant-Salt Technology Facility (CSTF), was undergoing shakedown tests when the MSR Program was interrupted in 1972.

Evidence of the corrosion product, Na_3CrF_6 , has been found in virtually all loops circulating sodium fluoroborate. The corrosion product is found in the coldest part of the circuit and is expected to deposit on tubes in the steam-raising equipment. For this reason, the solubility of Na_3CrF_6 in sodium fluoroborate was determined and cold trapping techniques were tested with limited success for isolating this material in natural- and forced-circulation loops. Excessive drain times have sometimes been encountered which were attributed to the accumulation of Na_3CrF_6 in drain lines.

10.3.2.2 Status of fluoroborate coolant technology

The compatibility of sodium fluoroborate with the proposed MSBR container material (Hastelloy N) is satisfactory (corrosion rate of 0.1 to 0.2 mil per year) provided that moisture is excluded from the system.²⁹

Heat transfer data obtained with the forced-convection loop FCL-2 are in good agreement with the empirical correlation of Sieder and Tate. These data indicate that sodium fluoroborate performs as a typical heat transfer fluid.³⁰

Experience with operation of the PKP-1 loop²⁸ indicates that the salt composition can be monitored by relating the thermal conductivity of the off-gas to the total system pressure and salt temperature, and the salt composition can be controlled by maintaining a suitable BF_3 partial pressure in the gas above the salt in the pump.

Fluoroborate salt mist is a potential problem with the large pumps contemplated in future molten-salt reactors. Although sodium fluoroborate undergoes a solid-phase transition at $\sim 470^{\circ}\text{F}$, no unusual problems associated with this phenomenon were encountered with operation of the freeze valves used in the forced-convection and PKP loops.

New or additional work is needed in the following areas:

1. Use of hydrogenous species in the coolant salt to control tritium migration (see Task 4.3.4 of Section 5).
2. Effect of corrosion product (Na_3CrF_6) deposits on steam generator performance and effectiveness of cold traps for ameliorating this problem.
3. Effect of solid-phase density change on system piping and components (see Section 10.6).
4. Feasibility of a BF_3 recovery and recycle system (see Section 10.7.6)
5. Management of secondary circuit off-gas line restrictions (see Section 10.7.6).
6. Variation of BF_3 partial pressure during gross mixing of fuel and coolant salts.

10.3.3 Steam-system technology development

The salt-to-steam interface in an MSR system will consist of steam generators and steam reheaters. The steam reheater is regarded as a conventional heat exchanger with no fundamental problems of heat transfer or development foreseen. Even though the 650°F reheat steam enters the reheater below the 725°F liquidus temperature of the coolant salt, the low steam-side heat-transfer coefficient leads to the conclusion that there will be no significant problem with freezing of the salt.

The steam generator tubes will contain supercritical steam and, in the reference design, will be in contact with sodium fluoroborate. The peak temperature on the steam side will be about 1000°F and that on the salt side will be 1150°F . Both of these fluids are corrosive under certain conditions. Sodium fluoroborate is aggressive if the salt has been in contact with water, and steam is oxidizing to metals and can produce stress corrosion cracking when it contains small concentrations of chlorides. Thus, the material used for steam generator tubes in a molten-salt system must resist corrosion by both sodium fluoroborate and steam, or duplex tubes must be used.

With the use of thermal baffles for the protection of the tube sheet, the 700°F feedwater entering the generator will cool some of the static salt below its 725°F liquidus temperature and the salt will freeze on

the colder surfaces. The steam generator design must accommodate the freezing and thawing of this small amount of salt without structural damage to the steam generator.

It is likely that direct maintenance of the steam generator will be possible even though there will be some induced sodium activity in the sodium fluoroborate. Estimates place the ^{24}Na activity at a sufficiently low value (about 11 μ curies per gram of salt) to allow for direct maintenance if the steam generator is drained of salt. Although the extent of the problem is uncertain at this time, it is possible that the maintenance plan will have to accommodate two other sources of radioactive contamination. Trace elements in Hastelloy N (such as cobalt) will be activated and could be subsequently dispersed throughout the coolant circuit by the corrosion process. Failure of a primary heat exchanger tube could allow fission products to enter the coolant and be dispersed throughout the secondary circuit. The design of the steam generator must accommodate the necessary maintenance and inspection to meet the requirements for in-service inspection, for minimizing down time, and for detection, location, and plugging of leaking or damaged steam tubes (see Section 11 for a discussion of maintenance technology development).

The steam-power system proposed for the MSBR reference design consists of supercritical cycle and equipment that is conventional except for the feedwater and reheat steam preheating facilities. The cycle used in the Bull Run steam station of the TVA was adapted for use with the MSBR in order to make the plant cost and performance estimates more realistic. The MSBR steam cycle uses steam at turbine throttle conditions of 3500 psia and 1000°F. Steam generator outlet steam attemperation is provided for control of turbine inlet conditions at part-load operation.

One of the two unconventional features in ORNL's adaptation of the TVA steam cycle is the two-stage reheat of extraction steam by use of a prime-steam-heated preheater and a salt-heated reheater. The other unconventional feature is the heating of feedwater to 700°F by direct mixing of the 866°F steam exiting the above preheater with the high pressure 550°F feedwater leaving the top extraction heater. Two large motor-driven, canned-rotor centrifugal pumps in parallel are used to boost about 19,000 gpm of feedwater from about 3500 psia to 3800 psia. Eight steps of feedwater heating are used in addition to the direct mixing step to obtain the 700°F feedwater temperature. The use of the supercritical cycle allows direct mixing without serious problems.

Based on the present conservative assumption that a 700°F feedwater temperature is necessary, a supercritical steam system is the only reasonable choice. Heating the feedwater to 700°F in a subcritical pressure cycle would require a very large amount of heat transfer surface or, more likely, use of the Loeffler cycle. The steam generator would become a superheater requiring a steam compressor and a much larger mass flow rate.

If use of feedwater at 580°F is determined to be feasible, the mixing chamber, pressure booster pumps, and reheat steam preheaters could be eliminated from the supercritical cycle. The increase in efficiency plus the simplification of the steam system would represent a substantial savings. Alternatively, a subcritical pressure steam cycle becomes feasible and can be included in the options for a MSBR power system. The feasibility of using lower feedwater temperature should be investigated for both subcritical and supercritical pressure steam cycles.

10.3.3.1 Experience

Since many of the problems of molten-salt and liquid-metal systems are similar, the experience being gained in the LMFBR program will be helpful in providing information which is either directly applicable or at least sufficiently similar to provide guidance in planning the development program. A few examples of LMFBR development areas in which problems are similar are as follows:

1. Work done in the development of high-temperature design criteria and thermal stress analysis of complex geometries will be applicable although the materials are not the same.
2. The problems of stability and flow reversal at low load on the tube and shell sides respectively are similar to those of a molten-salt generator.
3. The problems of overpressure protection and pressure pulse analysis of the secondary system are similar and portions of the LMFBR experience will be helpful in planning the molten-salt tests.
4. The LMFBR experience in the development of techniques for the fabrication of thick tube sheets and joining of tubes to tube sheets will be of benefit to the molten-salt program.

The coolant salt composition used in the MSRE is not the same as that proposed for the MSBR. However, preliminary heat transfer information obtained during operation of a small corrosion loop with sodium fluoroborate indicates general agreement with the Sieder-Tate correlation, and indicates that the use of accurate physical property data with correlations used for normal fluids is adequate for heat transfer design in fluoride salt systems. Correlations for heat transfer and pressure drop were chosen from the open literature and adapted for use in designing the MSBR reference primary heat exchanger and steam generator.

Although the operating experience with salts is quite extensive, there has been no experience in the generation of steam in high-temperature, molten-salt-heated steam generators. There is a considerable amount of experience, both in the USA and Europe, with a low-melting salt (Hitec) for the generation of low-pressure steam and as a heat transfer medium.⁸

The compatibility of Hastelloy N with steam has been investigated in a test facility in the TVA Bull Run Steam Plant. Unstressed specimens that were exposed to steam at 1000°F had very acceptable metal loss rates (<0.25 mil/year). Work has been conducted to evaluate the possibilities of stress corrosion of Hastelloy N in the presence of steam as reported by Spalaris et al.⁹ based on their rather limited work.

Some tests have been performed on duplex tubing manufactured by the International Nickel Company which consisted of Incoloy 800 on the steam side (inside) and nickel on the salt side. In this arrangement, these materials have excellent compatibility with salt and steam.

10.3.3.2 Status of technology

As previously mentioned, the unconventional feedwater heating requirements of the MSBR reference steam cycle require the use of booster pumps and mixing chambers. Although both of these components are currently in use at conditions near those required, the sizes needed for a 1000-MW(e) MSBR are not presently available. While carrying out work under an ORNL subcontract, Ebasco Services, Inc., found that the canned-rotor booster pumps needed for the MSBR steam cycle are about 50% larger than the largest known pump built to date.¹⁰ Consequently, development of larger capacity, multistage pumps would be needed. The mixing chambers needed are also larger than those in use, but this does not appear to impose a major development problem since a chamber similar to one specified for the MSBR system and about four-fifths as large is in use at the TVA Bull Run Steam Plant.

As an alternative, a high-pressure heat exchanger could be used to obtain the 700°F feedwater. The exit heating steam could be then heated to 1000°F in a salt-heated exchanger and reintroduced into the cycle, thereby eliminating the pressure booster pumps.

Working under ORNL subcontract, Ebasco Services, Inc., examined alternative steam systems but selected essentially the same steam system as the ORNL reference system.¹¹ They concluded that the use of direct mixing for feedwater heating and the special booster pumps is feasible and within foreseeable technological development. With the background of MSRE experience and the subsequent development operation, there is confidence in predicting salt-side heat transfer coefficients if accurate physical property data are available. More testing and operating experience is needed with the reference-design salt compositions to verify present information concerning physical properties, heat transfer and pressure drop, and the avoidance of flow instability and stratification problems.

The corrosion experience with Hastelloy N in steam is mostly favorable; however, several questions must be resolved before a firm conclusion can be reached. The duplex tubing of nickel-Incoloy 800 looks promising: the compatibility is excellent, and production methods for the tubing

have been developed so that a high quality product can be obtained at a lower cost than Hastelloy N tubing. On the other hand, steam generator fabrication would be complicated by use of duplex tubing.

A considerable amount of information is available on the use of supercritical steam: over 140 supercritical pressure steam generation units are now operating, under construction, or on order in the United States, Europe, and Japan. Design of molten-salt steam generators can draw on this experience.

Some work has been done with computer simulations of the control of the MSBR system, as discussed in Section 12. The results indicated that in order to maintain both the primary salt and the coolant salt cold leg temperatures above their respective liquidus temperatures, either of two control schemes would be satisfactory; both require a variable coolant salt flow. One control scheme would require attemperation of outlet steam before it reaches the turbine and the second would require a controlled bypass flow of coolant salt around the primary heat exchanger. The attemperation of outlet steam between the steam generator and the turbine introduces some uncertainty in turbine protection, while the controlled bypass flow would require the development of a salt throttling valve. The problems of attemperation will be explored as part of the steam generator industrial program. The salt valve requirements are discussed later (Section 10.3.7). Some work has been done at ORNL with a hybrid computer to identify and define various control and emergency transients which will be imposed on heat exchangers¹² so that the designer can effectively deal with them by either control system design or structural design.

A steam generator development report has been prepared¹³ which presents the basis for the development of molten-salt-heated steam generators and associated auxiliaries such as a startup system and a secondary salt pressure-relief system. This report reviews the LMFBR program experience in areas which appear applicable to molten-salt steam generators. Also, a conceptual design description has been prepared for a 3-MW Steam Generator Tube Test Stand (STTS) for the preliminary development testing of multitube assemblies.

Conceptual designs of molten-salt primary heat exchangers and steam generators have been or are being prepared by ORNL, Ebasco Services, Inc., Foster Wheeler Corporation, and by Black and Veatch. The conceptual design being considered for the reference MSBR system by Foster Wheeler under an ORNL subcontract consists of an "L" configuration sized at 483 MW for a single-unit-per-coolant-loop design. The unit would contain 1032 tubes (3/4 in. OD, 0.125 in. wall), and would be about 116 ft tall. Long flow (instead of cross flow) is being considered on the shell side to avoid the high pressure drop which results from attempting to meet conflicting requirements of vibration and baffle spacing.

One steam generator configuration which will receive attention in future design studies and has promise of alleviating the feedwater temperature

requirement uses the bayonet or re-entrant tube concept. Although investigations thus far indicate that the bayonet tube configuration is not practical at supercritical pressures because of the thick tube wall required, it has definite possibilities for a subcritical pressure system.

10.3.4 Cover and off-gas system technology development

The cover and off-gas systems for a molten-salt reactor must (1) protect the fuel and coolant salts from oxidizing atmospheres, and (2) provide positive containment of the radioactive noble gases and daughters and any other radioactive material which might be transferred from the fuel system.

In the fuel off-gas system for the reference design MSBR,³¹ fission product gases, together with helium carrier gas and entrained salt, are stripped from the fuel system by means of a gas separator and venturi. The gas passes first through the fuel-salt drain tank (and, if necessary, a particle trap) where entrained salt and non-volatile fission products are removed, and then through a 47-hr charcoal-bed holdup system where 97% of the Xe-135 is permitted to decay. The gas is then split into two streams, one of which (80%) is returned to the fuel system via the bubble generator. The other stream (20%) is passed through a long-delay charcoal-bed holdup system where all radioactive gases except Kr-85 are allowed to decay to insignificant levels, and through a cleanup system for removal of gaseous fission products and other contaminants. This stream is then recycled to the primary system for re-use as purge gas. No radioactive fission products are discharged to the atmosphere.

10.3.4.1 Experience

Charcoal-bed holdup systems were used to treat the fuel system off-gas streams from the Homogeneous Reactor Test (HRT) and the Molten-Salt Reactor Experiment (MSRE). Also, charcoal beds are currently being used to treat gas streams in solid-fuel reactors and processing systems. The MSRE off-gas systems generally operated satisfactorily except for occasional plugging of the off-gas lines due partly to organic material and partly to entrained salt and non-volatile fission products. The MSRE cover gas supply system used a titanium-sponge reactor and a molecular-sieve column for removal of trace quantities of water and oxygen from the gas.

10.3.4.2 Status of cover and off-gas system technology

Dynamic adsorption coefficients have been measured for Kr and Xe on charcoal in the temperature range 25 to 100°C.³²

Computer programs have been developed and used for the calculation of charcoal bed temperature profiles, pipe sizes, and charcoal quantities for both the HRT and the MSRE. However, the programs do not provide an optimum design, and a certain amount of iteration and interpretation is necessary.

The use of side-stream iodine strippers has been suggested as a method for minimizing the Xe-135 poison fraction in the MSBR. This concept was not included in the reference design, but conceptual design studies were carried out in sufficient detail to indicate that the gas flow would be about 2.3 m³/sec (4800 cfm) and that the gas should contain 1% HF to change the redox potential of the salt. If a decision were made to use iodine strippers, a different approach to the design of the off-gas system would be required since the high gas flow would make the charcoal-bed holdup system impractical.

New or additional work is needed in the following areas:

1. The dynamic adsorption coefficients for Kr and Xe on charcoal need to be experimentally determined for the temperature range 100°C to the highest anticipated operating temperature, currently 250°C. Other charcoal-related questions which need investigation are thermal stability, nature and quantity of charcoal outgassing at elevated temperatures, and effect of solids loading on the adsorption coefficient.
2. Particle traps may be needed to prevent plugging of pipe lines in both the fuel and coolant salt off-gas systems. Additional work is needed to enable prediction of the character and quantity of entrained solids and establishment of criteria for the design of particle traps.

10.3.5 Salt pump development

The pumps for molten-salt breeder reactors must circulate fluoride salts in primary (fuel) and secondary (coolant) salt systems reliably at temperatures as high as 1300°F. Electromagnetic and centrifugal pumps have been considered for this application. The low electrical conductivity of molten fluoride salts hinders the application of electromagnetic pumps, and, consequently, they are not used in fluoride salt systems. In contrast, centrifugal pumps have been applied very satisfactorily. A study¹⁵ of the problems of applying the canned-rotor motor and the short-shaft and long-shaft configurations of the centrifugal pump to molten-salt service was made in 1967. The canned-rotor pump was concluded to be a very desirable configuration, since there are no orientation or elevation limitations on its application. However, it would require difficult and expensive development to provide pumps for an MSBR application, including the development of a high-temperature electric motor having electrical insulation that has a very high resistance to nuclear radiation damage. Thus efforts have been centered on sump pumps, and all pumps built or proposed for MSBR's are centrifugal sump pumps.

This pump can be considered to have two basic configurations that are differentiated by shaft length and type of shaft support bearings. The short-shaft pump has a rotary element which contains conventional, oil-lubricated bearings that support the shaft from which the impeller is overhung. In the long-shaft pump the lower end of the shaft is supported by a molten-salt-lubricated bearing. This type of pump might be preferable for reactor salt systems that require locating the impeller at relatively low elevations in the system layout.

All salt pumps built for test facility and reactor operation at ORNL have been of the short-shaft configuration, and this pump type is proposed for the primary salt system in the reference design for a single fluid MSBR.¹⁶ Except for its larger capacity, this pump is very similar to those used in 1954 in the ARE, those proposed for the Aircraft Reactor Test (ART) in the late 1950's,¹⁷ and those operated for over 20,000 hours in the MSRE in the 1960's. Efforts were made to elicit industrial interest in the production of salt pumps for the ARE, ART, MSRE, and associated molten-salt test facilities. However, the number of pumps to be produced at any one time was apparently too small to obtain serious industrial interest. In 1969, a specification¹⁸ was written for a short-shaft centrifugal pump to provide the requirements of the primary and secondary salt systems in a 100- to 200-MW(t) MSBE. Westinghouse Electro Mechanical Division responded favorably to the request, but due to the deemphasis of the MSBR in 1970 their proposal was dropped.

Although the long-shaft centrifugal pump having salt-lubricated bearings has been proposed as an alternate to the short-shaft pump, experience with molten-salt-lubricated bearings is very limited. Test bearings were operated at ORNL in 1960, and a PKP model pump was modified in 1962 and operated for approximately 12,500 hr at 1225°F with the lower end of the shaft supported with a molten-salt-lubricated bearing. Because large-scale pumps of this configuration were outside known experience, ORNL had the rotor dynamics of the shaft-bearing-housing system and the characteristics of molten-salt-lubricated bearings examined in some detail by Mechanical Technology Inc.¹⁹ This study defined many of the remaining problems and produced recommendations for a development program.

10.3.6 Primary salt-salt heat exchanger development

The operation of the MSRE represents the most-recent large-scale experience with salt-to-salt heat exchangers.²⁰ This operation provided a considerable amount of confidence in the design techniques and in predicted performance information.

The heat transfer correlations used for the MSRE primary heat exchanger were based on the previous development tests which showed that fluoride salts behave as normal fluids. When the MSRE operation revealed the overall heat transfer coefficient to be less than predicted, a reevaluation of the physical properties disclosed that the actual thermal conductivities of the fuel and coolant salts were below those used in the design calculations and accounted for the difference.²¹ The overall heat

transfer coefficient of the MSRE heat exchanger did not change during some 22,000 hr of salt circulation and 13,000 equivalent full-power hours of operation, thus indicating no buildup of scale and no evidence of gas filming.

The fuel- and coolant-salt compositions used in the MSRE are not the same as those proposed for the MSBR. However, some preliminary heat transfer information from the operation of a small corrosion loop with sodium fluoroborate indicates general agreement with the Sieder-Tate correlation.²² Thus, the use of accurate physical property data with correlations for normal fluids is adequate for heat transfer design with fluoride salts. There is, however, no molten-salt heat transfer experience with the knurled tubes proposed for the primary heat exchanger in the ORNL reference design, nor is information available on the effects of sodium fluoroborate corrosion product deposition on the tubes.

The overall conditions in the MSBR system impose several specific design requirements on the primary heat exchangers:

1. The volume of fuel salt in the heat exchanger must be kept as low as practical to minimize the fuel doubling time for the reactor.
2. The entrance and exit salt temperatures, pressure drops, and the total heat transfer capacity must conform with the overall system operating conditions.
3. The type of heat exchanger, general location of nozzles, height of the unit, and minimum tube diameter must be compatible with various design, layout, and fabrication considerations.
4. The heat exchanger must be arranged for relatively easy tube-bundle replacement by means of remotely operated tooling.
5. All portions of the exchangers in contact with the fuel or coolant salt must have adequate corrosion resistance. As in any heat exchanger, the physical properties of the material establish maximum allowable temperature gradients across walls, allowable stresses, and the degree of flexibility required to accommodate differential expansions.
6. Flow velocities, baffle thickness, tube clearance, and baffle spacing should be selected to minimize possibilities of vibration.

Within the framework of the above requirements and guidelines, design procedures²³ and a computer program²⁴ were developed to produce an efficient heat exchanger design having a low fuel-salt volume.

10.3.7 Valve development

Valves will be required in molten-salt reactors for isolating portions of the reactor while the remainder operates, directing flow to alternate

paths, and providing flow variations for meeting start-up and off-design conditions. For the MSBR, shut off valves will be required in sizes up to 6 inches and throttling valves in sizes up to 24 inches.

Freeze valves operated successfully in the MSRE and in many out-of-pile tests at ORNL in sizes up to 1-1/2-in. IPS pipe. More than 125 valves of this type have been used, and more than 650,000 hr of operating time has been accumulated. Freeze valves have been operated with salts as diverse as the eutectic mixture of NaBF_4 -NaF (92-8 mole %), which has a 725°F melting point, and LiF, which has a 1560°F melting point.

Five 4-in. throttling valves were designed and fabricated at ORNL around 1955 for flow control in five pump loops that operated with molten salts and liquid metals. The valves were designed for throttling service only and were fabricated of Inconel. They were operated for a total time of 114,000 hr at temperatures ranging from 1000 to 1500°F, and no bellows failure or significant mechanical problems occurred during that time. Tests of bellows-sealed mechanical valves were conducted around 1957 in the Aircraft Nuclear Propulsion Program in an attempt to develop a 1-1/2-in. shut-off valve for molten salt at temperatures of 1200 to 1500°F. The valve seat material was considered to be the major problem, and although a successful valve was not developed prior to cancellation of the work, promising seat and plug material combinations were investigated. Bellows-sealed valves up to a few inches in size have been used successfully in many sodium applications. Most sodium valves of larger size, however, have had sodium freeze seals on the valve stems, and this option is not available for molten-salt valves. However, the valve design, fabrication, and operation presently planned in the LMFBR program should provide much useful information to aid molten-salt valve development.

10.3.8 Control rod development

The design of the MSBR takes advantage of the ease of adding fuel while the reactor is operating to minimize the excess reactivity in the core, and the ability to drain the fuel to effect complete reactor shutdown. However, control rods which have both regulating and shimming functions and safety rods used primarily for reactor shutdown are included in the reference design. The control rods are graphite cylinders operating directly in the salt. The safety rods are boron carbide (clad in Hastelloy N) and also operate directly in the salt.

The control and safety rods of the ARE and MSRE were operated in metal thimbles that separated them from the salt and therefore required auxiliary gas cooling. Because the rods and drives were separated from the salt there was no problem of gas seals for fission product control.

The poison material for the ARE safety rod was B_4C , and stainless steel served as poison for the control rod.²⁵ The poison element for the MSRE control rod²⁶ was a mixture of gadolinium and aluminum oxides, formed

and sintered into a number of short cylindrical tubes which were in turn canned in Inconel. Visual observation of some of the canned elements at the end of the reactor operation revealed no significant changes in dimensions or external appearance.

There has been no experience with control rods operated directly in the salt; however, the physical arrangement and provisions for cooling might be similar to that in the liquid-metal-cooled reactors. In one proposal for a control rod for use with a liquid-metal-cooled reactor, the poison section is guided within a duct which is positioned within the core. The MSBR reference design uses graphite ducts for guiding the safety rods and the graphite control rods.

The materials proposed for the poison elements for the MSBR are similar to those used in the ARE. There is wide experience with forming rare-earth oxides and B_4C into usable shapes and canning the elements to protect them from the environment. Experience is lacking with such elements in a high neutron flux field; however, work is in progress within the LMFBR Program.

10.3.9 Containment and cell heating development

The molten-salt reactor plant differs from other reactor plants in that large amounts of fission products are dispersed throughout the reactor primary system and several auxiliary systems. To alleviate the possibility of escape of radioactivity, double containment is provided for equipment that contains the bulk of the radioactive liquids and gases. For secondary containment, the general design for an MSBR can follow the design that has come to be rather standard for nuclear reactors, and no unusual construction techniques seem to be involved in building the cylindrical shell. Since much of the equipment and piping contain fuel salt, heating must be supplied to preheat and maintain it at 1000°F or higher. The MSBR primary system design calls for using the reactor and fuel drain tank cells as ovens for preheating the equipment and piping. The HTGR primary containment concept is very similar to this, with comparable temperatures and much higher design pressures, and experience gained with supporting heavy equipment in this environment and with cell wall cooling should provide much useful information and guidance.

10.4 TASK GROUP 9.1 FUEL SALT TECHNOLOGY DEVELOPMENT

10.4.1 Objective

The objective of this task group is to develop the technology associated with the fuel salt system that is necessary for design of the primary circuit of a molten-salt test reactor and for confident scale up to a molten-salt demonstration reactor.

10.4.2 Schedule

As indicated in Table 10.4.2, construction of the Gas-Systems Technology Facility will be completed for water operation in FY 1975, and the water tests will be carried out. In FY 1976, modification of the GSTF for salt operation will be completed, facility shakedown will be done, and test operation will be started. The primary emphasis will be on evaluating the performance of the bubble generator-bubble separator. In FY 1977, testing of the bubble generator-bubble separator will continue but the emphasis will switch to other tests such as tritium transport studies, salt chemistry studies, and mass transfer measurements.

The work in FY 1976 and 1977 will be directed toward obtaining general information in all problem areas related to fuel salt system technology rather than refining the data in one specific area. With this approach, there should be no overall uncertainties concerning the fuel salt system, and refinement of data can be delayed until about FY 1980.

The remainder of the development work in the Gas-Systems Technology Facility should be completed during FY 1981, as well as studies for evaluation of xenon removal. The remainder of the known development work in this task group can be finished by FY 1984.

10.4.3 Funding

The operating fund requirements for this task group are summarized in Table 10.4.3.1. Capital equipment funds for this task group are shown in Table 10.4.3.2.

10.4.4 Facilities

Most of the early work associated with this task group will be done in the Gas-Systems Technology Facility (GSTF), a facility for circulating molten salt at approximately 1000 gpm over the temperature range of 566 to 704°C (1050 to 1300°F). The salt to be used during most of the system operation will be of the same composition as the fuel salt proposed for an MSBR.

Figure 10.4.4 is a simplified diagram of the main systems of the facility. The salt circulating system consists of a modified MSRE MARK II pump and two parallel pipe loops. The main loop contains a flow measuring venturi, a bubble separator, a flow restrictor, and a bubble generator. The supply and discharge from the salt pump contain supply and return connections for future auxiliary loops. The loop piping and the bulk-salt separator are fabricated from 5-in. Hastelloy N pipe. Metallurgical surveillance specimens are installed in the main loop to allow periodic checks on the extent of corrosion of the system.

Table 10.4.2. Schedule for work in Task Group 9.1 - Fuel salt technology development

	Fiscal year											
	1975	1976	1977	1978	1979	1980	1981	1982	1983	1984	1985	
9.1.1 GSTF water tests												
9.1.1.1 Pump and flow restrictor	—											
9.1.1.2 Bubble generator-bubble separator	—											
9.1.2 GSTF salt studies												
9.1.2.1 Bubble generator-bubble separator		—										
9.1.2.2 Tritium transport			—	—								
9.1.2.3 Salt chemistry			—	—								
9.1.2.4 Mass transfer			—	—								
9.1.2.5 Heat transfer			—	—								
9.1.2.6 Materials studies			—	—								
9.1.2.7 Salt jets			—	—								
9.1.3 After heat removal												
9.1.4 Salt sampler												
9.1.5 Xenon removal evaluation												

Table 10.4.3.1. Operating fund requirements for Task Group 9.1 - Fuel salt technology development
(costs in 1000 dollars)

	Fiscal year											
	1975	1976	1977	1978	1979	1980	1981	1982	1983	1984	1985	
9.1.1 GSTF water tests												
9.1.1.1 Pump and flow restrictor	92											
9.1.1.2 Bubble generator-bubble separator	20											
Subtotal 9.1.1	112											
9.1.2 GSTF salt studies												
9.1.2.1 Bubble generator-bubble separator	73	170	80	50	50	50						
9.1.2.2 Tritium transport		20	50	50		50						
9.1.2.3 Salt chemistry		30	40	30	30	50		150	150			
9.1.2.4 Mass transfer			50				50					
9.1.2.5 Heat transfer				20	60	60						
9.1.2.6 Materials studies		10	10	10	10	80						
9.1.2.7 Salt jets					50	100	50					
Subtotal 9.1.2	73	230	230	160	200	390	100	150	150			
9.1.3 After heat removal						50	100					
9.1.4 Salt sampler									100	200		
9.1.5 Xenon removal evaluation					50							
Total operating funds for Task Group 9.1	185	230	230	160	250	440	200	150	250	200		

Table 10.4.3.2. Capital equipment fund requirements for Task Group 9.1 - Fuel salt technology development
(costs in 1000 dollars)

	Fiscal year									
	1975	1976	1977	1978	1979	1980	1981	1982	1983	1984
9.1.2.1 Miscellaneous instruments and equipment	28	16						50	60	
9.1.2.1 Pump rotary element		50								
9.1.3 Test stand for afterheat studies						50				
Total capital equipment funds for Task Group 9.1	28	66				50		50	60	

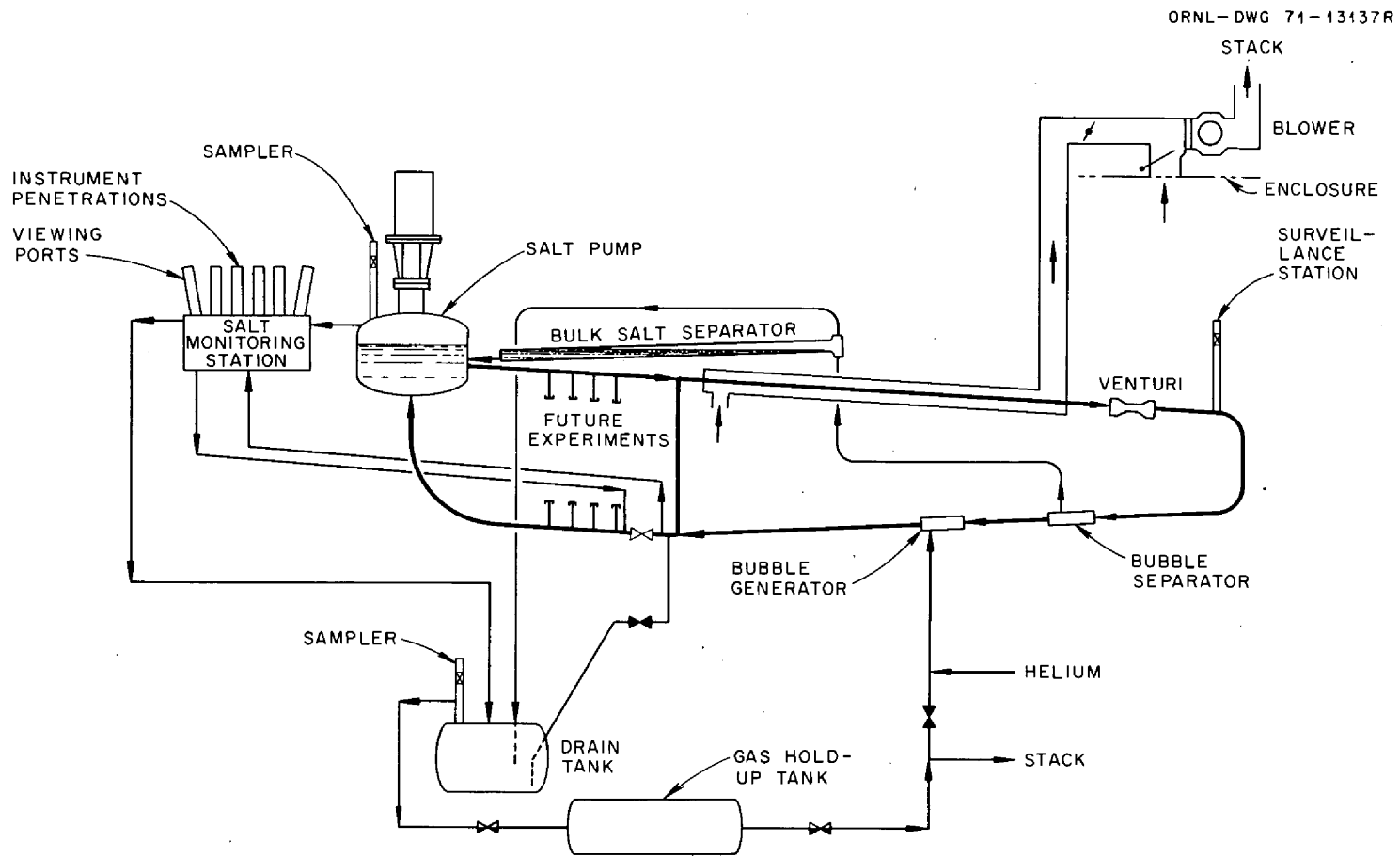

Fig. 10.4.4. GSTF schematic.

A small stream of salt is diverted to a salt-monitoring vessel which has provisions for inserting probes for on-line monitoring of the chemical composition of the salt. Samples of the salt can be removed from the salt-monitoring vessel, the salt pump, or the drain tank. The drain tank is separated from the loop by a freeze valve in the connecting salt line.

All salt-containing components are heated with electrical heaters which are capable of holding the component temperatures as high as 704°C (1300°F).

Helium is supplied to the loop by the cover-gas system which contains dryers and oxygen-removal units. The largest flow of gas is to the bubble generator with smaller flows to the salt pump shaft and to the bubbler-type level elements. The combined off-gas stream flows through a holdup volume and a pressure-throttling valve to simulate the MSBR off-gas system.

In normal operation the gas space in the salt pump operates at a pressure of 15 psig. The pump has a rated flow of 1000 gpm at a discharge pressure of 156 psig. The salt flow through the main loop is 500 gpm. Gas can be injected into the bubble generator at flow rates as high as 37 std. liters/min and is removed at the bubble separator along with an accompanying salt flow ranging from 11 to 9.5 gpm. Almost all of the salt is separated from the gas in the bulk-salt separator and returned to the salt pump. The gas flows to the drain tank where it combines with the other gas flows. The gas from the drain tank is either discarded to the stack or recycled to the bubble generator. The bubble fraction in the loop is measured by a gamma densitometer downstream of the bubble separator. The salt and gas flow rates which can be obtained in the GSTF are equal to those anticipated in the xenon removal side stream of a 150-Mw(t) MSR, and allow for large-scale testing of many aspects of the xenon removal system.

Other work related to the fuel salt system will be carried out in individual facilities or in the Components Test Facility (see Section 10.13).

10.4.5 Task 9.1.1 Gas-Systems Technology Facility water tests

After construction of the facility has been completed, components and systems will be tested. In addition, the salt system will be operated with water to determine the system operating characteristics and to test various components such as the bubble generator-bubble separator.

10.4.5.1 Subtask 9.1.1.1 Test of the salt pump and variable flow restrictors

The salt pump being used is a MSRE MARK II pump which has been modified to obtain characteristics similar to the MSBR pump by altering the pump inlet and volute. Since confidence in the calculations for mis-matched impellers and volute is not adequate, the hydraulic performance of the

pump will be tested during the first stage of the water runs. The shaft deflection will also be measured during this period. Based on this information, the final pump modifications will be made including sizing of the impeller. The pump and variable flow restrictors will then be calibrated.

The time and operating funds required for completion of facility construction and shakedown are included in this subtask.

10.4.5.2 Subtask 9.1.1.2 Tests of the bubble generator-bubble separator

Helium will be injected into the water through the bubble generator and removed at the bubble separator at flow rates in the range of those anticipated for salt operation. The efficiency of the bubble separator for gas removal will be determined, using the measured bubble fraction downstream of the bubble separator and the gas flow rate to the bubble generator.

Some mass transfer information may be obtained by injecting oxygen into the bubble generator in order to saturate the water with oxygen; the rate of change of oxygen concentration with time would then be determined after resuming helium injection.

10.4.6 Task 9.1.2 Gas-Systems Technology Facility fuel-salt studies

10.4.6.1 Subtask 9.1.2.1 Bubble generator-bubble separator evaluation

After modifications have been made to the facility to allow salt operation, the performance of the bubble generator and bubble separator will be evaluated using salt under various operating conditions. The effects of salt redox potential on bubble generator-bubble separator performance will be determined. If necessary, modifications to the bubble generator or bubble separator will be made as the work progresses.

The time and funds spent modifying the system for salt operation, addition of salt, and shakedown are included in this subtask.

10.4.6.2 Subtask 9.1.2.2 Tritium transport studies

The need for resolution of questions related to tritium management and disposal has led to laboratory investigations of the chemical relationships which govern tritium transport (see Section 5). As these studies advance, it will be desirable to corroborate laboratory tests in an operating salt loop. Use may be made of tritium as a tracer in the investigation of diffusion or mass transfer. Alternately, deuterium might be used, although its detection (by mass spectroscopy) is a factor of 10^3 less sensitive than that for tritium.

10.4.6.3 Subtask 9.1.2.3 Salt chemistry studies

A number of studies related to salt chemistry are of interest, and the need for others may become apparent as work progresses. One series of experiments will be performed for determining the relationship between U^{4+}/U^{3+} ratio and salt surface tension. This work is motivated by the observations in the MSRE of lowered salt surface tension after adjustment of redox potential by the addition of metallic beryllium to the fuel salt, and by questions relating to the effect of redox potential on xenon removal efficiency.

The role of non-wetted metal particulates, and their relation to bubble behavior also needs further study. Provisions will be made, if possible, for careful evaluation of gas-borne species in terms of particle size distribution and composition of particulates and gas, as a function of the controlled chemical and operational parameters.

Sodium fluoroborate injection, detection and removal from fuel salt will also be investigated.

10.4.6.4 Subtask 9.1.2.4 Mass-transfer studies

The mass transfer coefficient between a gas dissolved in a liquid and a gas bubble is in general a function of the Schmidt and Reynolds moduli. The parameters varied in water tests to date have been velocity, pipe diameter, and kinematic viscosity; and since the tests were both isothermal and isobaric, the diffusion coefficient in the Schmidt modulus was a constant. The bubble size must also be known to determine the mass transfer coefficient uniquely from the concentration-versus-time data taken in the water tests. Until the advent of suitable instrumentation for determining bubble size in a high-temperature circulating salt, and in the absence of knowledge about molecular diffusion of gases through salt, mass transfer experimentation will be limited to a determination of the product of the mass transfer coefficient and the effective bubble surface area. Although this does not permit a general correlation, such information would be useful in conjunction with data from the bubble generator tests under the same conditions of salt flow, chemistry, temperature and stripper gas void fraction. Measurements will be made of dissolved noble gas (possibly using a radioactive tracer) as a function of time under various conditions of salt flow rates, temperature, chemistry, and stripper gas void fraction. Variation of test section diameter and orientation may also be included.

10.4.6.5 Subtask 9.1.2.5 Heat transfer tests

To date, heat-transfer tests with MSBR fuel salt have involved once-through test sections without the presence of gas bubbles. The Gas-Systems Technology Facility allows not only the corroboration of previous data but also the determination of the effect of various gas void fractions on the heat-transfer coefficients, both in fully-developed flow and in regions where

boundary layers are developing. A resistance-heated tube, possibly similar to the proposed primary heat-exchanger tubes, will be connected across two of the capped pipe stubs provided. The variation of heat flux with Reynolds modulus will be measured over the range of values expected in the MSBR core and heat exchanger.

10.4.6.6 Subtask 9.1.2.6 Materials studies

Most of the materials development work for molten-salt reactors is covered in Sections 2, 4, and 9. This subtask covers work for determining compatibility of materials with fuel salt under operating conditions. Specimens will be exposed to flowing salt streams and side loop studies will be made using potential materials of construction.

10.4.6.7 Subtask 9.1.2.7 Salt jets development

Jets will be used in the MSBR to return overflow salt to the fuel-salt circulating systems and to transfer salt between the drain tank, the salt storage tank and the chemical processing facility. The design of these jets should be similar to that of water jets; however, prototypes will be tested in the Gas-Systems Technology Facility along with the proposed siphon-break piping.

10.4.7 Task 9.1.3 Afterheat removal systems development

A drain tank system is needed for molten-salt reactors which will cool the off-gas which passes through it and will remove the afterheat in case of a quick drain after shutdown of power. The proposed cooling system is similar to that used for the MSRE except that NaK thermal convection is used instead of condensing steam. Although this is a very important system, the design is straightforward and a minimum of development work should be required. Details of the development work required have not been determined.

10.4.8 Task 9.1.4 Salt sampler development

Although in-line analytical devices will be developed for future molten-salt reactors, occasional samples will need to be removed and analyzed in a hot cell. A suitable sampling method will be developed.

10.4.9 Task 9.1.5 Parametric evaluation studies for xenon removal

Studies will be made to determine the effects on xenon poisoning of such variables as bubble diameter distribution, void fraction, bubble separator efficiency, mass transfer coefficients, permeability of graphite, off-gas recycle time, iodine removal time, loop temperature, and loop pressures. If additional development work is identified by these studies, the work involved will be described in future subtasks.

10.5 TASK GROUP 9.2 COOLANT-SALT TECHNOLOGY DEVELOPMENT

10.5.1 Objectives

The objective of this task group is to develop the technology that is required for design, construction, and operation of the coolant-salt system of a molten-salt test reactor, and for confident scale-up to a molten-salt demonstration reactor.

10.5.2 Schedule

Work on this task group is scheduled to begin in FY 1975 and will continue through FY 1977 (see Table 10.5.2).

10.5.3 Funding

Operating funds required by this task group are shown in Table 10.5.3.

10.5.4 Facilities

The Coolant-Salt Technology Facility (CSTF) will serve as the primary tool for work in this task group. The facility,³³ shown schematically in Fig. 10.5.4, consists of a pump, a salt-to-air heat exchanger, a load orifice, a drain tank, a surveillance specimen assembly, a corrosion-product trap, a salt monitoring vessel, and the necessary connecting piping and auxiliary equipment. The main loop is constructed of 5-in. Hastelloy N pipe and is equipped with smaller diameter pipe taps on both the pump discharge and the pump suction lines to permit attachment of parallel salt circuits that will be used individually or simultaneously for future experiments. A fixed orifice, located at mid-loop, produces a pressure drop of 500 KN/m^2 (72 psi) and limits the main loop salt flow to 50 liters/sec (785 gpm). Impact tubes and orifices are used to control the salt flow at 0.13 liter/sec (2 gpm) in the salt monitoring vessel and 0.01 liter/sec (0.15 gpm) in the economizer loop. A mixture of helium and BF_3 is supplied to the vapor space of the pump bowl for salt composition control, and pure helium enters the pump bowl as shaft purge. The gas spaces in the pump bowl, float-type level chamber, salt monitoring vessel, and cold trap are interconnected for liquid level control in these chambers.

In addition to the CSTF, the Components Test Facility, the test reactor mockup, the test reactor, and the demonstrator reactor will also advance coolant-salt system technology.

Table 10.5.2. Schedule for work in Task Group 9.2 - Coolant salt technology development

	Fiscal year											
	1975	1976	1977	1978	1979	1980	1981	1982	1983	1984	1985	
9.2.1 Coolant Salt Technology Facility												
9.2.1.1 Tritium distribution calculations												
9.2.1.2 Hydrogen and deuterium studies												
9.2.1.3 Corrosion product trapping												
9.2.1.4 Salt chemistry												
9.2.1.5 Material surveillance												
9.2.2 Evaluation and design of larger components												

Table 10.5.3. Operating fund requirements for Task Group 9.2 -- Coolant salt technology development
(costs in 1000 dollars)

	Fiscal year											
	1975	1976	1977	1978	1979	1980	1981	1982	1983	1984	1985	
9.2.1 Coolant Salt Technology Facility												
9.2.1.1 Tritium distribution calculations	10	20	5									
9.2.1.2 Hydrogen and deuterium studies	115	180	65									
9.2.1.3 Corrosion product trapping	34	60	20									
9.2.1.4 Salt chemistry	5	20	5									
9.2.1.5 Material surveillance	5	10	5									
Subtotal 9.2.1	169	290	100									
9.2.2 Evaluation and design of larger components								100	200	200		
Total operating funds for Task Group 9.2	169	290	100					100	200	200		

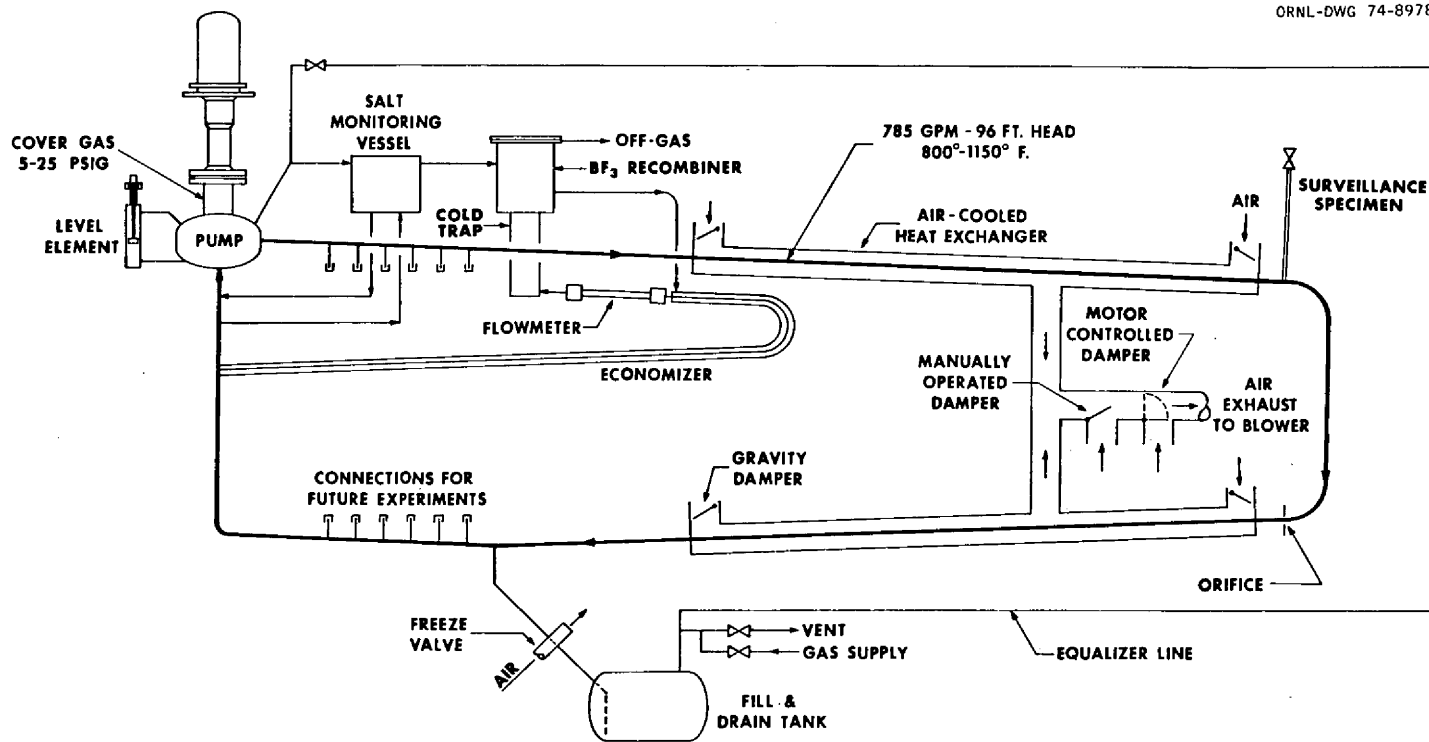

Fig. 10.5.4. CSTF schematic.

10.5.5 Task 9.2.1 CSTF studies (fluoroborate salt)

This task group includes experimental studies performed in, or in connection with, the CSTF. The work consists of tests for determining the distribution of hydrogen and deuterium in the CSTF from which the distribution of tritium in the coolant system of an MSBR can be inferred, study of corrosion product trapping, materials surveillance studies, and evaluation of in-line analytical devices. Work is also included on the design and evaluation of full-scale coolant-salt components; however, no experimental work on the larger components is covered in this task group.

10.5.5.1 Subtask 9.2.1.1 Tritium distribution studies

Mathematical models have been devised for predicting the distribution of tritium in molten-salt reactor systems.^{3,4} A review will be made of all pertinent calculations and additional calculations will be carried out as necessary for planning and analyzing the experimental program prior to, and in conjunction with, the deuterium-injection tests.

10.5.5.2 Subtask 9.2.1.2 Hydrogen- and deuterium-injection tests

The objective of this work is to simulate the anticipated behavior of tritium in the coolant-salt system and to investigate the possibilities of using that system as a barrier to resist migration of tritium from the fuel system to the steam system and thus to keep the concentration of tritium in the MSBR steam system from rising above the maximum acceptable level.³⁶ It is possible that certain hydrogenous materials in the coolant salt may serve to sequester the tritium and thus prevent its diffusion into the steam system.

The procedure for the initial injection experiments will be to allow a known volume of deuterium to diffuse directly into the circulating salt and, by appropriate sampling and analytical techniques, to determine the resulting change in the deuterium concentrations in the salt and off-gas streams.

The initial injection tests are expected to provide quantitative data only on the deuterium content of the salt and the off-gas. Later tests will be designed to yield quantitative data on the amount of deuterium which diffuses through the walls of the salt piping, since this information is essential to obtaining a meaningful deuterium material balance and to predicting behavior of tritium in an MSBR. The equipment for these tests may take the form of a test section inserted in one of the side loops of the CSTF.

10.5.5.3 Subtask 9.2.1.3 Corrosion product trapping

The objectives of the corrosion-product trapping studies are to (1) demonstrate that Na_3CrF_6 can be deposited onto a cold surface in an engineering-scale sodium fluoroborate circulating loop, and (2) determine the character

of the deposit. A cold trap unit, installed in a side loop of the CSTF, will be used for the corrosion product trapping studies. A description of the cold trap and associated flow circuit is given in the Final System Design Description³³ for the CSTF.

The corrosion product trapping studies will be carried out in two phases. The first phase will consist of observations and studies which are made while other work, such as deuterium injection and salt chemistry studies, is being carried out. During this phase, the cold trap studies will be of lower priority than the other work. The second phase of the experimental work will consist of studies wherein the types of deposits and rates of deposition are observed under conditions where the impurity level in the salt is adjusted by means of controlled additions. Tests will be carried out in which the chromium content of the salt will be changed by direct chromium addition, and in which steam will be injected directly into the salt.

10.5.5.4 Subtask 9.2.1.4 Salt chemistry

The chemistry of sodium fluoroborate is being studied to (1) develop information in support of the tritium and corrosion experiments, and (2) develop techniques for sampling and in-line analysis which are suitable for large molten-salt reactors. A salt-monitoring vessel is provided in the CSTF which will be used for testing in-line analytical techniques for measurements such as proton concentration in the salt. The primary work regarding salt chemistry is covered in Sections 5 and 6. The effort in this subtask will be restricted to (1) assisting investigators in application of the CSTF to the various problem areas, and (2) demonstrating through operation of the CSTF that proposed solutions are applicable to an actual reactor system.

10.5.5.5 Subtask 9.2.1.5 Materials surveillance tests

The materials surveillance tests will be conducted using the specimen surveillance system which is provided in the CSTF. Because of plans for using the specimen surveillance assembly in the deuterium-injection tests, the assembly has been redesigned so that it will be able to serve the dual role of injection tube and specimen holder.³⁶

The objective of the material surveillance tests is to provide information on the compatibility of the $\text{NaBF}_4\text{-NaF}$ salt with Hastelloy N and with other selected materials. Corrosion, as indicated by the surveillance specimens, will be determined by weight change measurements, dimensional changes, and metallography on portions of the specimens. Execution of these tests will be handled as a part of the materials development effort which is covered in Section 2.

10.5.6 Task 9.2.2 Evaluation and design of larger components for coolant-salt technology development

The objective of this task is to evaluate the performance of full-scale coolant-salt components and systems. A single coolant loop in the reference design MSBR operates with a salt flow rate of $1 \text{ m}^3/\text{sec}$ (16,000 gpm) which is a factor of 20 larger than that for the CSTF. The experience gained in the execution of Task 9.2.1 in the CSTF will be applied to the designs of full-scale models of the cold trap, the BF_3 economizer, and the particle traps, and components of similar design will be tested in the Components Test Facility.

10.6 TASK GROUP 9.3 STEAM TECHNOLOGY DEVELOPMENT

10.6.1 Objective

The objective of this task group is to develop the technology required for the reliable evaluation, design, and fabrication of molten-salt-heated steam generators.

Liquid-heated steam generators are relatively new in the power generation field, and much development effort will be required to provide a molten-salt-heated steam generator with the essential characteristics of reliability, safety, performance, maintainability, and economy.

In order that steam generators can be supplied that will operate in a safe and reliable manner, work is outlined in this task group for developing the technology and skills required to complete this objective. Portions of the extensive development work being done with liquid-metal-heated steam generators will be useful to the Molten-Salt Reactor Program. The liquid-metal and the molten-salt steam generators have many problems in common and the LMFBR experience will be used in planning the necessary development program to achieve the objective of this task group.

10.6.2 Schedule

The schedule for work in this task group is shown in Table 10.6.2.

The plan for the development of steam-system technology is aimed almost entirely at the interface between the coolant salt and the steam system. The plan is divided into five progressive tasks, with interfaces between tasks selected to provide advanced levels of confidence in the technology before the commitment is made to proceed into the next task. The first task (9.3.1), which is presently in progress, is the beginning of the industrial program and involves industry in performing conceptual design studies of molten-salt steam generators. This design-study task, which will be completed in FY 1976, will provide industrial recommendations for development requirements.

Table 10.6.2. Schedule for work in Task Group 9.3 - Steam technology development

	Fiscal year												
	1975	1976	1977	1978	1979	1980	1981	1982	1983	1984	1985	1986	
9.3.1 Industrial steam generator design studies													
9.3.1.1 1000-MW(e) conceptual	—												
9.3.1.2 Lower feedwater studies		—											
9.3.1.3 MSTR conceptual		—											
9.3.1.4 Recommended R&D			—										
9.3.1.5 Review corrosion work	—												
9.3.1.6 Review CSTF plans		—											
9.3.2 Design studies and small scale development													
9.3.2.1 CSTF steam generator studies		—											
9.3.2.2 Develop pressure relief device			—										
9.3.2.3 Small leak detection			—										
9.3.2.4 Small leak wastage			—										
9.3.2.5 Preliminary startup and control studies			—										
9.3.2.6 Develop fabrication techniques				—									
9.3.2.7 Alternate steam generator materials				—									
9.3.2.8 Thermal-hydraulic and physical property data				—									
9.3.2.9 Coolant salt extrusion coefficient				—									
9.3.2.10 Update R&D plan					—								

Table 10.6.2 (continued)

	Fiscal year												
	1975	1976	1977	1978	1979	1980	1981	1982	1983	1984	1985	1986	
9.3.3 Steam generator tube test stand													
9.3.3.1 Conceptual design			—										
9.3.3.2 Criteria and pressure relief system design					—								
9.3.3.3 Maintenance, cleaning, and inspection procedures					—								
9.3.3.4 Test stand Title I and Title II design					—								
9.3.3.5 Test stand fabrication						—							
9.3.3.6 Design of tube test assembly					—								
9.3.3.7 Fabrication of tube test assembly						—							
9.3.3.8 Operation								—					
9.3.4 Steam generator model test installation													
9.3.4.1 Preliminary design of model steam generator													
9.3.4.2 Final design of model steam generator						—							
9.3.4.3 Fabrication of model steam generator								—					
9.3.4.4 SGMTI conceptual design					—								
9.3.4.5 SGMTI Title I and Title II design							—						
9.3.4.6 SGMTI construction								—					

Table 10.6.2 (continued)

	Fiscal year												
	1975	1976	1977	1978	1979	1980	1981	1982	1983	1984	1985	1986	
9.3.4.7 Model steam generator testing													
9.3.4.8 Overpressure system testing													
9.3.4.9 Steam leak detection													
9.3.4.10 Steam generator startup													
9.3.4.11 Destructive examination and evaluation													
9.3.5 Equipment and controls development													
9.3.5.1 Establish criteria													

The second task (9.3.2) will consist of small-scale exploratory development necessary for the design and operation of a multitube steam generator assembly described under the third task (9.3.3). Also, the second task will begin preliminary design of startup and control systems for steam generators, and development of fabrication techniques and alternate materials in support of the third task. Small-scale tests of 100 to 150 kW will be performed using a side stream of the CSTF. The work of this task should be well underway by the end of FY 1978 to provide a firm basis for beginning design of the Steam Generator Tube Test Stand (STTS) of the third task (9.3.3).

The third task (9.3.3) will incorporate the development results obtained thus far into the design of a Steam Generator Tube Test Stand incorporating several full-size steam tubes (STTS). Multitube test assemblies of industrial design will be operated in the STTS.

The fourth task (9.3.4) will involve the design, construction, and operation of the Steam Generator Model Test Installation (SGMTI). Although task 9.3.3 will not be complete in FY 1981, the necessary information from this task will be available for the design of the model steam generator and the SGMTI by this time.

The fifth task involves establishing the equipment and controls criteria necessary for all steam generator operating modes. After the successful test has demonstrated the adequacy of the basic design criteria of the model steam generator and its support equipment, the final design, fabrication, and testing of MSTR prototype steam generators will begin in FY 1981 (see Section 13). The molten-salt test reactor mockup (MSTRM) will contain at least one steam generator unit in the mockup of the coolant system along with the required over-pressure protection system. Although only limited steam generator performance tests can be performed in the mockup, the safety of the steam generator and its over-pressure protection system will be demonstrated by simulating a steam tube rupture. Procedures for semi-direct maintenance, cleanup after a tube rupture, and inservice inspection will be tested by FY 1986.

10.6.3 Funding

Operating fund requirements for this task group are given in Table 10.6.3.1, and capital equipment fund requirements are given in Table 10.6.3.2.

Authorization of funds for the design and construction of the Steam Generator Tube Test Stand in the amount of \$4 million will be required early in FY 1979. Authorization of funds for the design and construction of the Model Steam Generator Test Installation in the amount of \$20 million will be required early in FY 1981.

Table 10.6.3.1. Operating fund requirements for Task Group 9.3 - Steam technology development
(costs in 1000 dollars)

	Fiscal year												
	1975	1976	1977	1978	1979	1980	1981	1982	1983	1984	1985	1986	
9.3.1 Industrial steam generator design studies													
9.3.1.1 1000-MW(e) conceptual	50												
9.3.1.2 Lower feedwater studies		168											
9.3.1.3 MSTR conceptual		45											
9.3.1.4 Recommended R&D		30											
9.3.1.5 Review corrosion work	6												
9.3.1.6 Review CSTF plans		7											
Subtotal 9.3.1	56	250											
9.3.2 Design studies and small scale development													
9.3.2.1 CSTF steam generator studies		30	150										
9.3.2.2 Develop pressure relief device			100	120	120								
9.3.2.3 Small leak detection			30	30									
9.3.2.4 Small leak wastage				100	120								
9.3.2.5 Preliminary startup and control studies					100	120							
9.3.2.6 Develop fabrication techniques						120	120						
9.3.2.7 Alternate steam generator materials						120	120						
9.3.2.8 Thermal-hydraulic and physical property data			200	200									

Table 10.6.3.1 (continued)

		Fiscal year											
		1975	1976	1977	1978	1979	1980	1981	1982	1983	1984	1985	1986
9.3.2.9	Coolant salt extrusion coefficient			60	130								
9.3.2.10	Update R&D plan					50							
	Subtotal 9.3.2		30	540	580	390	360	240					
9.3.3	Steam generator tube test stand												
9.3.3.1	Conceptual design			40	20								
9.3.3.2	Criteria and pressure relief system design					50							
9.3.3.3	Maintenance, cleaning, and inspection procedures					60	60						
9.3.3.4	Test stand Title I and Title II design					10	20	10					
9.3.3.5	Test stand fabrication												
9.3.3.6	Design of tube test assembly					100	100						
9.3.3.7	Fabrication of tube test assembly							200	200				
9.3.3.8	Operation							200	350	550			
	Subtotal 9.3.3			40	20	220	380	410	350	550			
9.3.4	Steam generator model test installation												
9.3.4.1	Preliminary design of model steam generator						100	100					
9.3.4.2	Final design of model steam generator							300					

Table 10.6.3.1 (continued)

	Fiscal year											
	1975	1976	1977	1978	1979	1980	1981	1982	1983	1984	1985	1986
9.3.4.3 Fabrication of model steam generator								800				
9.3.4.4 SGMTI conceptual design					200	100						
9.3.4.5 SGMTI Title I and Title II design							50					
9.3.4.6 SGMTI construction								50	100			
9.3.4.7 Model steam generator testing									150	600	300	
9.3.4.8 Overpressure system testing									75	100	100	
9.3.4.9 Steam leak detection										100	60	
9.3.4.10 Steam generator startup									75	100	80	
9.3.4.11 Destructive examination and evaluation												300
Subtotal 9.3.4					200	200	450	850	400	900	840	
9.3.5 Equipment and controls development												
9.3.5.1 Establish criteria						150	150		250	300	360	
Subtotal 9.3.5						150	150		250	300	360	
Total operating funds for Task Group 9.3	56	280	580	600	810	1090	1250	1200	1200	1200	1200	

Table 10.6.3.2. Capital equipment fund requirements for Task Group 9.3 - Steam technology development
(costs in 1000 dollars)

	Fiscal year									
	1976	1977	1978	1979	1980	1981	1982	1983	1984	1985
9.3.2.1 Miscellaneous instruments		10								
9.3.2.2 Miscellaneous equipment and instruments		5	10							
9.3.2.4 Miscellaneous equipment			10							
9.3.3.8 Miscellaneous instruments		20								
9.3.5 Equipment and controls criteria								200	250	
Total capital equipments for Task Group 9.3		35	20					200	250	

10.6.4 Facilities

The facilities necessary for steam-system technology development will consist for the most part of molten-salt facilities with the steam generator as the primary focus. Steam-system equipment not in contact with salt will involve the scale-up and adaptation of existing technology and will be done by industrial firms.

The facilities required for the development of molten-salt steam generators are covered in the following subsections.

10.6.4.1 Facilities for Task 9.3.1 Industrial steam generator conceptual design studies

No hardware is required for this portion of the industrial program which is presently in progress. As discussed in Subtask 9.3.1.4, the industrial firm performing this study will make recommendations for a development program for molten-salt steam generators.

10.6.4.2 Facilities for Task 9.3.2 Small-scale exploratory development

Exploratory development will be performed both as secondary function tests in other salt test facilities and as primary function tests in new test facilities.

The Coolant-Salt Technology Facility will be utilized for small-scale, single-tube, steam generation tests (Subtask 9.3.2.1), and for preliminary development of a steam-leak detector system (Subtask 9.3.2.3). Separate facilities will be required for development of a pressure relief device (Subtask 9.3.2.2) and for steam wastage parameters (Subtask 9.3.2.4). The development of fabrication techniques and alternative materials (Subtasks 9.3.2.6 and 9.3.2.7) are material development problems and will be performed in existing materials development facilities.

Small-scale facilities will be required for obtaining precise thermal, hydraulic, and physical data for the coolant salt (Subtask 9.3.2.8) such as have been measured for other salts. In addition to the engineering properties data at normal operating temperatures, a special investigation will be made of the coolant salt near its liquidus temperature (Subtask 9.3.2.9) since portions of a steam generator will operate near the liquidus temperature. Investigations will be performed to determine the macroscopic density change of the coolant at both the liquidus and the solid-phase transition temperature. Information on the resistance of the salt to extrusion will be measured.

10.6.4.3 Facilities for Task 9.3.3 Preliminary steam generator design and development

The major facility for this task is the Steam Generator Tube Test Stand (STTS) which will require a heat source of about 3 MW(t) and must accommodate full-length, multitube test assemblies, which will be designed by industrial firms. See Subtasks 9.3.3.1 through 9.3.3.8.

The STTS will include a system for circulating molten salt and a steam-feedwater system that can be operated at subcritical or supercritical pressures. Feedwater treatment will be equivalent to that of supercritical power plants. In addition to the required subsystems for support of the salt and steam-feedwater systems, a pressure relief system will be required to protect the salt piping from overpressure in the event of a steam-tube failure.

10.6.4.4 Facilities for Task 9.3.4 Model testing in the Steam Generator Model Test Installation (SGMTI)

Steam generator models of 20- to 25-MW(t) capacity will be tested in the Steam Generator Model Test Installation which will be located in the Components Test Facility (described in Task Group 9.10). This installation will consist of a 30-MW(t) salt heater, coolant salt system, over pressure protection system, supercritical steam system, heat dump and other support equipment necessary to simulate important portions of a steam generator and allow study of the phenomena which take place in a molten-salt-heated steam generator.

10.6.5 Task 9.3.1 Industrial steam generator conceptual design studies

A conceptual design study, presently in progress by Foster Wheeler Corporation, under ORNL subcontract, will include conceptual designs, recommendations for steam generator development and critical reviews of present plans.

10.6.5.1 Subtask 9.3.1.1 Conceptual design for a 1000-MW(e) MSBR

Foster Wheeler Corporation, under ORNL subcontract, is preparing a conceptual design of a steam generator for the 1000-MW(e) MSBR reference plant. This steam generator is to utilize a supercritical steam cycle to produce steam at 1000°F and 3500 psia from feedwater at 700°F.

10.6.5.2 Subtask 9.3.1.2 Feasibility study for use of lower feedwater temperature

Foster Wheeler Corporation, under ORNL subcontract, will investigate the feasibility of using a lower feedwater temperature of 500 to 600°F with

both supercritical and subcritical steam systems. If the results of the investigation are favorable, conceptual designs will be prepared for one or both conditions.

10.6.5.3 Subtask 9.3.1.3 Conceptual design of MSTR steam generator

A steam generator conceptual design will be prepared of a size appropriate for the MSTR; however, the steam generator size has not been fixed at this time. The design will be based on an evaluation of the results of subtasks 9.3.1.1 and 9.3.1.2 above.

10.6.5.4 Subtask 9.3.1.4 Recommend R & D program

After completing Subtasks 9.3.1.1 through 9.3.1.3, Foster Wheeler Corporation, under ORNL subcontract, will recommend a research and development program for carrying out the work necessary for development of steam generators in view their experience with conventional steam generator design and with the background of having performed molten-salt steam generator studies. A reevaluation and possible redirection of emphasis for the remainder of the steam generator development program is possible as a result of these recommendations.

10.6.5.5 Subtask 9.3.1.4 Critical review of Hastelloy N-steam corrosion work

Foster Wheeler Corporation, under ORNL subcontract, will provide a critical review of past and present Hastelloy N-to-steam corrosion work and make recommendations on steam generator materials. It is likely that these recommendations will lead to further materials studies since only limited work has been done on materials behavior in salt-steam environments.

10.6.5.6 Subtask 9.3.1.6 Critical review of ORNL plans for CSTF

Foster Wheeler Corporation, under ORNL subcontract, will review and evaluate ORNL's steam generator technology loop (which will operate in conjunction with the CSTF, Task 9.2.1). A small test of 100 to 150 kW(t) will be described in a conceptual design report. See Subtask 9.3.2.1.

10.6.6 Task 9.3.2 Design studies and small scale exploratory development

10.6.6.1 Subtask 9.3.2.1 Small scale steam generator tests in the CSTF (See para 10.5.4)

Important preliminary information concerning the generation of steam in a molten-salt-heated exchanger will be obtained as a basis for proceeding with larger-scale steam generator development. A small bypass on the CSTF will be used to supply salt at a sufficient rate to provide

50 to 150 kW of heat to the exchanger. Information will be developed on desirable tube configurations, heat transfer coefficients, and flow stability.

10.6.6.2 Subtask 9.3.2.2 Development of a molten-salt pressure relief device

To prevent overpressure of the coolant-salt system in the event of a steam tube failure, a pressure relief device and a collection system for the effluent must be provided. A device must be developed which will operate reliably at high temperature and in contact with molten salt. This device may be an adaptation of an existing device.

10.6.6.3 Subtask 9.3.2.3 Development of small-leak detection system

The CSTF will be used to develop methods for detecting small steam leaks into the coolant salt. Early detection of a small steam leak from the steam generator will allow shutdown and repair before the failure progresses to the stage where the pressure relief system would be brought into service. Injections of water into the coolant salt of the CSTF and the evaluation of various leak-detection methods will form the basis for further development in the larger steam generator facilities to follow.

10.6.6.4 Subtask 9.3.2.4 Determination of small-leak wastage parameters

Information on the extent of damage and the wastage rate of steam tube walls vs leak size will provide plant shut-down criteria. Wastage parameters will provide input to the steam generator design concerning tube geometry, spacing, etc. The experience of the LMFBR program will be utilized in obtaining wastage parameters with static-pot tests.

10.6.6.5 Subtask 9.3.2.5 Preliminary design study of steam generator startup and control systems

The startup system must provide for the initial coupling of the salt-heated steam generator to the steam system without freezing of salt and with a minimum of thermal shock. A separate fossil-fired startup system with a capacity of about 10% of rated plant capacity may be necessary. Preliminary studies, including computer simulations, will investigate various startup and control schemes and provide a basis for further development in the large steam generators to follow.

10.6.6.6 Subtask 9.3.2.6 Develop fabrication techniques for steam generator

Specific joint designs, fabrication procedures, and inspection procedures have not been chosen at this time. Problems will be resolved as they arise in the design and with the participation of industrial firms.

10.6.6.7 Subtask 9.3.2.7 Investigate and develop alternative steam generator materials

In the event that Hastelloy N is incompatible with steam under stress, other materials will be investigated. Information on the compatibility of many materials, including Incoloy 800 and Inconel 600, with steam is available. However, the evaluation of these materials in contact with coolant salt will be necessary.

An evaluation will be made of duplex tubing as a solution to the materials problem, where each side of the tube is compatible with its respective environment, namely, Incoloy 800 with steam and nickel with the coolant salt. The main problems to be resolved are the integrity of the bimetal interface and joining techniques.

10.6.6.8 Subtasks 9.3.2.8 and 9.3.2.9

These two subtasks are concerned with physical properties of the coolant salt that are of particular importance to the steam generator design. In addition to the more accurate engineering data necessary over the normal operating temperature range (Subtask 9.3.2.8), additional information is needed in the region near the salt liquidus temperature. Temperatures at the inside tube wall at the tube sheet surface near the feedwater inlet will be below the salt liquidus and, therefore, some salt freezing will occur. The nature of the frozen salt layer and the possible mechanical consequences of the freezing and thawing of this layer must be better understood. This subtask will investigate the possibility of determining an extrusion coefficient by methods similar to those used in the extrusion of metals. With this information, stresses resulting from the density change in thawing salt could be calculated and accommodated in the steam generator design.

The two subtasks associated with coolant-salt properties are as follows:

Subtask 9.3.2.8 - Assess the adequacy of the thermal-hydraulic and physical property data for the coolant salt (see Task Group 9.2) for steam generator design needs.

Subtask 9.3.2.9 - Determine extrusion coefficient and investigate other physical properties of coolant salt near liquidus temperature.

10.6.6.9 Subtask 9.3.2.10 Update R & D program plan

As a result of the industrial design studies of steam generators (Subtask 9.3.1.4) and the small scale exploratory development work (Task 9.3.2) up to this point, the overall development plan will be reexamined for proper direction and emphasis.

10.6.7 Task 9.3.3 Steam Generator Tube Test Stand design, construction, and operation

The purpose of task 9.3.3 is to establish a more firm understanding of the critical engineering features of molten-salt-heated steam generators.

10.6.7.1 Subtasks 9.3.3.1 through 9.3.3.8

The subtasks of this task are concerned with a 3-MW(t) molten-salt Steam Generator Tube Test Stand (STTS) in which three or more full size steam tubes will be tested. These tests will range from evaluation of the thermal and mechanical stability of some design features to the operation of some full-size steam tubes in the STTS for evaluation of performance under full heat flux conditions. The larger-scale tests requiring a heated circulating salt system would be conducted in the STTS.

A Conceptual System Design Description of a 3-MW facility of this type has been completed. The primary functions of the STTS are to:

1. Perform steady-state part- and full-rated load tests on clusters of full-size, full-length tubes in a configuration representative of MSTR-MSBR steam generators.
2. Perform transient studies associated with load changes at rates up to 5%/min over the range from 20 to 100% of full load.
3. Demonstrate startup of steam generators that use high-melting-point salts for the heat source.
4. Provide a single test facility for the evaluation of steam generator test sections from several industrial firms.
5. Continue the demonstration of the technology for sodium fluoroborate or other fluoride salts necessary for their application to steam generation in the following task (9.3.4) of model testing.

The power rating of 3 MW for the test stand is based on the need to evaluate the flow stability in the tubes of a multi-tube test assembly. Although the design provides for a minimum of three tubes in a test assembly, studies of steam generators for the MSBR reference design indicate that none of the systems proposed would have tubes of 1-MW(th) size, and that the size would be closer to 1/4 MW(th). Seven to 12

tubes would be used in the stability tests. The design of the facility may have to be modified to satisfy requirements resulting from the industrial design studies conducted in Task 9.3.1 in order to incorporate recommendations of the industrial designer.

The subtasks associated with the STTS are as follows:

Subtask 9.3.3.1 - Conceptual design of Steam Generator Tube Test Stand (STTS)

Subtask 9.3.3.2 - Establish criteria and design pressure relief systems for the STTS

Subtask 9.3.3.3 - Establish maintenance criteria and develop necessary procedures for maintenance, cleaning, and in-service inspection

Subtask 9.3.3.4 - Title I and Title II design of the STTS

Subtask 9.3.3.5 - Fabrication of the STTS

Subtask 9.3.3.6 - Industrial design of multi-tube test assembly for STTS

Subtask 9.3.3.7 - Industrial fabrication of test assembly for STTS

Subtask 9.3.3.8 - Operation of the STTS with multitube assemblies

10.6.8 Task 9.3.4 Model testing in the Steam Generator Model Test Installation (SGMTI) - Subtasks 9.3.4.1 through 9.3.4.11

Model testing of a molten-salt steam generator will be done in a test facility with functions and a size similar to that of the Sodium Components Test Installation (SCTI) of the LMFBR Program. This test facility will supply about 20 to 30 MW of heat to a molten-salt-heated steam generator model and will include all of the auxiliary systems and support equipment necessary to subject the model to conditions simulating those expected in service.

The test facility will include the necessary salt handling and circulating system, salt heater, cover gas and leak detection system, overpressure protection system, salt diversion valves and system controls to apply temperature ramps and control transients, a supercritical steam generator, and a startup system to provide initial coupling without excessive thermal shock and without freezing salt.

The steam generator model will be designed and fabricated by industry and will incorporate the results of the design and preliminary testing experience available at that time. The industrial firm supplying the model steam generator will participate heavily in the definition of the test program and the development of its supporting systems.

The 11 subtasks associated with the testing of steam generator models are as follows:

- Subtask 9.3.4.1 - Preliminary industrial design of model steam generator
- Subtask 9.3.4.2 - Industrial design of model steam generator
- Subtask 9.3.4.3 - Industrial fabrication of model steam generator
- Subtask 9.3.4.4 - Conceptual design of the SGMTI
- Subtask 9.3.4.5 - Title I and Title II design of the SGMTI
- Subtask 9.3.4.6 - Construction of the SGMTI
- Subtask 9.3.4.7 - Performance testing of the model steam generator
- Subtask 9.3.4.8 - Testing of the overpressure protection system
- Subtask 9.3.4.9 - Testing of the steam-leak detection system
- Subtask 9.3.4.10 - Testing of the steam generator startup system
- Subtask 9.3.4.11 - Destructive examination and final data evaluation

10.6.9 Task 9.3.5 Equipment and controls criteria development

The type and size of equipment for the steam generator auxiliary system is a major uncertainty due to the lack of experience in this area. The size of the startup system, for example, will depend on how stably the steam generator operates at low loads. Computer simulation studies using the best thermal-hydraulic characteristics available at the time will guide the design of the steam generator and provide feedback to the control criteria. Temperature transients due to both normal and abnormal operating conditions and the thermal stresses they bring about must be included in information available to the designers. Other equipment development needs such as a bypass or diversion valve will be evaluated on the basis of computer simulator studies. This subtask interfaces strongly with Tasks 11.1.1 and 11.1.2.

10.7 TASK GROUP 9.4 COVER- AND OFF-GAS SYSTEM TECHNOLOGY DEVELOPMENT

10.7.1 Objective

The objective of this task group is to develop the technology that is needed for the design of the cover- and off-gas systems and components of a molten-salt test reactor and for confident scale-up to a molten-salt demonstration reactor.

10.7.2 Schedule

The schedule for work in this task group is given in Table 10.7.2.

10.7.3 Funding

The operating fund requirements for this task group are shown in Table 10.7.3. Capital equipment funds in the amount of \$40,000 will be required during FY 1978 for equipment and instrumentation to be used in the charcoal tests (Subtask 9.4.2.1).

10.7.4 Facilities

The Gas System Technology Facility (GSTF) and the Coolant-Salt Technology Facility (CSTF) will be used for work in this task group during the initial phases of the program. These facilities, which are described in Sections 10.4.4 and 10.5.4, will be used for particle trap studies (Subtasks 9.4.1.1 and 2), BF_3 management studies (Subtask 9.4.2.4), and removal of tritium from coolant salt (Subtask 9.4.2.5).

The charcoal tests (Subtask 9.4.2.1) will require a special test facility but one which should be modest in size, complexity and cost. The facility will include charcoal-filled pipes equipped with heaters and temperature controls, a gas supply system with flow controls, and provisions for obtaining gas samples and making radiation counts. The arrangement will be similar to that used previously.³²

Special test facilities will be required for the tritium and noble-gas-removal tests (Subtasks 9.4.2.2 and 3). The facilities will be scale models of systems which are proposed for the molten-salt test reactor and they will be designed as a proof test of system performance. These same facilities may also be adapted for use in performance testing of the recycle gas compressor (Subtask 9.4.2.6).

10.7.5 Task 9.4.1 Handling of non-volatile constituents

The offgas stream from the reference MSBR³¹ primary system will contain mists or smokes at relatively low concentration (probably somewhere between 100 and 1000 ppm by volume) and constituted as follows:

Table 10.7.2. Schedule for work in Task Group 9.4 — Cover and off-gas system technology development

	Fiscal year									
	1976	1977	1978	1979	1980	1981	1982	1983	1984	1985
9.4.1 Non-volatile constituents										
9.4.1.1 Fuel system particle trap										
9.4.1.2 Coolant system particle trap										
9.4.1.3 Non-volatile fission product disposal										
9.4.2 Volatile constituents										
9.4.2.1 Charcoal bed tests										
9.4.2.2 Removal of tritium from fuel offgas										
9.4.2.3 Removal of ⁸⁵ Kr										
9.4.2.4 BF ₃ recycle										
9.4.2.5 Removal of tritium from coolant offgas										
9.4.2.6 Recycle gas compressor										

Table 10.7.3. Operating fund requirements for Task Group 9.4 - Cover and off-gas system
(costs in 1000 dollars)

	Fiscal year									
	1976	1977	1978	1979	1980	1981	1982	1983	1984	1985
9.4.1 Non-volatile constituents										
9.4.1.1 Fuel system particle trap		10	20							
9.4.1.2 Coolant system particle trap			20	20						
9.4.1.3 Non-volatile fission product disposal							10	20	10	
Subtotal 9.4.1		10	40	20			10	20	10	
9.4.2 Volatile constituents										
9.4.2.1 Charcoal bed tests		50	80	40						
9.4.2.2 Removal of tritium from fuel offgas					20	40	20			
9.4.2.3 Removal of ⁸⁵ Kr					20	100	30			
9.4.2.4 BF ₃ recycle					20	20	20			
9.4.2.5 Removal of tritium from coolant offgas					20	20	20			
9.4.2.6 Recycle gas compressor							10	20	30	
Subtotal 9.4.2		50	80	40	80	180	100	20	30	
Total operating funds for Task Group 9.4		60	120	60	80	180	110	40	40	

1. Fuel salt particles, generated in the pump bowl and the bubble separator, having potential sizes ranging from 1 to 10 microns.
2. An estimated³⁷ 1% to 50% of the noble metal (⁴¹Nb through ⁵²Te) fission products as particles ranging in size from 0.01 to 10 μ . For a 2250-MW(t) reactor, the mass flow rate could be as high as 300 grams per day.
3. Non-volatile fission product daughters of Kr and Xe. The assumption is made that noble gas daughters which are born in the salt will be retained in the salt as fluorides. For a 2200-MW(t) reactor, and assuming a 2-hour gas holdup volume, an estimated 140 grams per day of noble-gas daughters will be formed in the primary salt drain tank.

The off-gas stream from the coolant salt system is expected to contain salt mist particles in about the same size range and concentration as the fuel system off-gas. However, the composition of the salt will be different and there will be no fission products, no radioactivity (except for some short-lived induced activity), and no decay heat.

10.7.5.1 Subtask 9.4.1.1 Particle trap for fuel system off-gas

In the MSBR reference design,³¹ a particle trap may be required at the outlet of the fuel salt drain tank. A particle trap will not be required if the drain tank serves as an efficient particle trap.

The objective of this task is to develop the technology related to the removal of particles by the drain tank to the point where a firm decision can be made regarding the need for a particle trap. The initial approach will be to assume that the Gas-System Technology Facility (GSTF) is representative of a reactor system. The rate of salt mist carryover from the GSTF drain tank will be measured and, if possible, tests will be devised to study the carryover of noble metals and noble-gas daughters. If the test results indicate that solids carryover will be a problem and that a particle trap will be required, work will be initiated on particle trap concepts and any accompanying experimental effort which might be indicated.

10.7.5.2 Subtask 9.4.1.2 Particle trap for coolant system off-gas

The initial objective of this task is to examine the problem of coolant-salt mist carryover and to determine whether a particle trap will be required. If a trap is required, criteria will be established for its design. Input data for the evaluation and design will be obtained from the operating experience with the CSTF off-gas system.

10.7.5.3 Subtask 9.4.1.3 Non-volatile fission product disposal

The objective of this task is to determine an acceptable procedure for disposing of solid fission products which accumulate in the charcoal beds or other parts of the off-gas system.

10.7.6 Task 9.4.2 Handling of volatile constituents

The off-gas stream from both the fuel system and the coolant system of the reference MSBR³¹ will contain volatile constituents which will present management or disposal problems. The fuel system offgas will contain radioactive krypton and xenon as well as tritium. This gas will be passed through charcoal delay beds to allow the decay of short-lived isotopes, after which the Kr-85 and tritium would be placed in a satisfactory form for disposal. The coolant-system offgas will contain BF₃ and tritium which must be placed in a form allowing disposal.

10.7.6.1 Subtask 9.4.2.1 Charcoal bed holdup test for fuel system off-gas

The reference design MSBR includes a charcoal delay bed through which the fuel system off-gas passes. Parts of the delay bed system operate at temperatures as high as 250°C. The effluent gas, after suitable cleanup, is recycled to the purge gas supply system. Adsorption coefficient data will be determined experimentally for the expected operating temperature range in order to augment the present data which extend to only 100°C. Also, tests will be made to determine the effect on the adsorption coefficient of solids deposition resulting from fission product decay. A study will be made to determine what procedures will be necessary to handle adsorbed materials such as oxygen and water which might be present in the as-received charcoal. Also, the thermal stability of charcoal will be examined to determine whether operation at 250°C causes evolution of organic materials or degradation of physical properties.

For determining the adsorption coefficients, a test setup similar to the one used for making the low temperature tests³² will be required. By also adding the necessary sampling or analytical equipment, the same system can be used for the cleanup and thermal stability tests.

10.7.6.2 Subtask 9.4.2.2 Removal of tritium from fuel system off-gas

In the reference design MSBR, tritium in the fuel system off-gas will be reacted with hot CuO to form tritiated water which will be isolated by means of a refrigerated adsorbent. The technology for this process is well established and experimental work will be limited to proof-testing of the method in a mockup of the system.

10.7.6.3 Subtask 9.4.2.3 Removal of Kr-85 and stable Kr and Xe from fuel system off-gas

A 2250-MW(t) reactor will produce about 60 liters per day of Kr-85 plus stable Kr and Xe. This material, along with the tritiated water (see previous section) will be isolated by means of a refrigerated adsorbent. The technology for this process is well established and experimental work will be limited to proof-testing of the method in a mockup of the system. The mockup would be designed to demonstrate the performance and reliability of the CuO reactor for tritium oxidation and the refrigerated adsorbent and liquid-nitrogen trap for isolating the noble gases and the tritiated water.

10.7.6.4 Subtask 9.4.2.4 Management of BF₃ in coolant system off-gas

Methods will be developed for safe and economical management of BF₃ in the coolant cover- and off-gas system. This subtask would include design and experimental work needed to develop a BF₃ recycle system. Input data for this task will be obtained through operating experience with the BF₃ economizer which is installed in the CSTF.

10.7.6.5 Subtask 9.4.2.5 Removal of tritium from coolant system off-gas

About 2500 curies per day of tritium will be produced in a 2250-MW(t) molten-salt reactor. A large fraction of this gas is expected to be transported from the fuel system into the coolant system. A method will be developed for handling and disposing of the tritium which is transported into the coolant salt off-gas system. Work in this subtask will be closely coordinated with the previous subtask (BF₃ management) to ensure that the respective approaches are compatible. The approach to this problem may be strongly affected by information developed in the deuterium-injection tests (Subtask 9.2.1.2) and related work.

10.7.6.6 Subtask 9.4.2.6 Recycle-gas compressor

The reference design MSBR specifies that the primary system off-gas will be recompressed and reused as purge gas for the primary system. The objective of this subtask is to provide the engineering effort needed to identify a commercial compressor, or develop a compressor which will do the job effectively and reliably without contaminating the pumped fluid with wet air or other materials. Design criteria will be established after which the availability of commercial units will be determined.

10.8 TASK GROUP 9.5 SALT PUMP DEVELOPMENT

10.8.1 Objectives

The objectives of this task group include the development of the technology necessary for design of short-shaft salt pumps for molten-salt test and demonstration reactors and the procurement and testing of full-scale prototypical pumps for the test and demonstration reactors. It is recognized that industrial participation via ORNL subcontract or industry-supported development is an important factor, and appropriate measures will be taken to ensure that this input will be forthcoming. Another objective is the investigation of salt-lubricated bearings, and their development to a point that a long-shaft prototype pump can be designed.

To the extent possible, the pumps required for the molten-salt test reactor will be the same as those to be used in the demonstration reactor in order that the number of prototype salt pumps to be developed will be minimized.

10.8.2 Schedule

The schedule for work in this task group is shown in Table 10.8.2. Work on the short shaft pump will start as soon as pump requirements have been determined in FY 1978. The specifications would be completed, and requests for industrial bids would be issued in FY 1978. After bid evaluation, conceptual design by industry of the MSTR prototype pump would be started in FY 1979. Detail design will start in FY 1980, and construction in FY 1981. Delivery of a prototype pump would be expected by the end of FY 1983. The design of the pump test stand for the Components Test Facility would start in FY 1979, which would be sufficiently early for the test stand to be ready by the time the pump arrives. Pump testing will start in FY 1983.

The development of molten-salt-lubricated bearings for a long-shaft pump will be started in FY 1980 in case the design indicates an advantage to using this type pump. If this occurs, additional work would be required to develop this pump type.

10.8.3 Funding

Operating fund requirements for the task group are shown in Table 10.8.3. The largest expense item is associated with the design and construction of the prototype pump. Authorization of funds (\$1 million) for the design and construction of the Salt Pump Test Stand will be required in FY 1980.

10.8.4 Facilities

Most of the development will be done in the Salt Pump Test Stand in the Components Test Facility (10.13).

Table 10.8.2. Schedule for work in Task Group 9.5 - Salt pump development

	Fiscal year									
	1977	1978	1979	1980	1981	1982	1983	1984	1985	1986
9.5.1 Short shaft pump development										
9.5.1.1 MSTR primary pump specifications and RFP		—								
9.5.1.2 Evaluation of proposals			—							
9.5.1.3 Industrial design of MSTR prototype pump				—	—					
9.5.1.4 Construction of MSTR prototype pump					—	—				
9.5.1.5 Design pump test stand				—	—	—				
9.5.1.6 Construction of pump test stand						—	—			
9.5.1.7 MSTR prototype pump tests							—	—	—	
9.5.2 Salt-lubricated bearing development										
9.5.2.1 Review technology				—	—					
9.5.2.2 Bearing development					—	—				

Table 10.8.3. Operating fund requirements for work in Task Group 9.5 - Salt pump development
(costs in 1000 dollars)

	Fiscal year									
	1977	1978	1979	1980	1981	1982	1983	1984	1985	1986
9.5.1 Short shaft pump development										
9.5.1.1 MSTR primary pump specifications and RFP		40								
9.5.1.2 Evaluation of proposals			40							
9.5.1.3 Industrial design of MSTR prototype pump			80	560	760					
9.5.1.4 Construction of MSTR prototype pump					700	1200	900			
9.5.1.5 Design pump test stand			20	25	25					
9.5.1.6 Construction of pump test stand						25	25			
9.5.1.7 MSTR prototype pump tests							150	300	300	
Subtotal 9.5.1		40	140	585	1485	1225	1075	300	300	
9.5.2 Salt-lubricated bearing development										
9.5.2.1 Review technology				40						
9.5.2.2 Bearing development					80					
Subtotal 9.5.2				40	80					
Total operating funds for Task Group 9.5		40	140	625	1565	1225	1075	300	300	

10.8.5 Task 9.5.1 Development of short-shaft pumps

10.8.5.1 Subtask 9.5.1.1 Develop specifications for a prototype pump for the molten-salt test reactor

In 1969, detailed specifications were developed for a primary salt pump (Spec. M-10554-RB-001-X-0) and a secondary pump (Spec. M-10554-RB-002-X-0) for the Molten-Salt Breeder Experiment. These specifications would be thoroughly reviewed and modified as necessary in view of the molten-salt test reactor requirements, and industrial bids would be solicited for a prototype pump for the molten-salt test reactor.

10.8.5.2 Subtask 9.5.1.2 Evaluate industrial bids for the prototype pump

After all the bids have been received they will be thoroughly analyzed to ensure that the desired design procedures will be carried out.

10.8.5.3 Subtask 9.5.1.3 Industrial design of prototype pump

This subtask will involve both conceptual and final prototype pump design and will include independent review and approval.

10.8.5.4 Subtask 9.5.1.4 Construct prototype pump

One or more prototype pumps will be constructed by one or more qualified vendors with periodic consultations and inspections by an independent reviewer.

10.8.5.5 Subtask 9.5.1.5 Design pump test stand in the Components Test Facility

A preliminary design description for a pump test stand for an MSBE size pump was written in 1969. This information will be the basis for the design of the pump test stand in the Components Test Facility.

10.8.5.6 Subtask 9.5.1.6 Construct pump test stand in the Components Test Facility

This subtask covers the construction of the pump test stand and installation of the prototype pump.

10.8.5.7 Subtask 9.5.1.7 Test prototype pump

Some of the tests to be done in the pump test stand are listed below:

1. Obtain the pump hydraulic performance and cavitation inception characteristics over a wide range of pump speeds, capacities, and temperatures.
2. Determine the startup and coastdown characteristics of the pump and drive motor under load conditions.
3. Determine the characteristics of the purge gas flow in the shaft annulus.
4. Determine the distribution of salt aerosols produced by pump operation and obtain the performance characteristics of aerosol removal devices, if necessary.
5. Demonstrate the operability of the incipient failure detection (IFD) devices.
6. Obtain long-term endurance operation with prototypic pumps.
7. Make molten-salt proof tests of advanced instrumentation for molten-salt systems as it becomes available.

10.8.6 Task 9.5.2 Development of molten-salt-lubricated bearings

10.8.6.1 Subtask 9.5.2.1 Status of technology report

This subtask will involve a literature search and consultations with LMFBR personnel and with Mechanical Technology, Inc. personnel in order to determine and summarize the status of development of long-shaft pumps for molten-salt service.

10.8.6.2 Subtask 9.5.2.2 Define and perform development program

Based on the technology report, a detailed development program will be outlined and carried out which will provide information necessary for the design of large scale long-shaft pumps. Current information indicates that this will include fabrication of long shafts to precise concentricity, straightness, and dynamic balancing, as well as providing mechanical devices to accommodate the relatively large differential thermal expansion that occurs between a shaft and bearing support constructed of Hastelloy N and journals and sleeves constructed of refractory metals or cemented carbides having smaller coefficients of thermal expansion.

10.9 TASK GROUP 9.6 PRIMARY SALT-SALT HEAT EXCHANGER DEVELOPMENT

10.9.1 Objective

The objective of this task group is to develop the technology which will allow detailed design of a primary heat exchanger for the molten-salt test reactor. Final optimization of heat exchanger design to minimize fuel salt inventory for the molten-salt demonstration reactor and MSBR will be done after tests in the molten salt test reactor.

10.9.2 Schedule

As indicated in Table 10.9.2, the status of technology report should be completed in FY 1981, and development work finished in FY 1983.

10.9.3 Funding

Operating fund requirements for this task group are shown in Table 10.9.3. The higher rate of spending in FY 1983 is associated with proof testing for the molten-salt test reactor. Capital equipment funds of \$50,000 will be required during FY 1982 for modification of the GSTF and CSTF to allow heat exchange studies.

10.9.4 Facilities

Some of the early work in this task group will be done in the Coolant-Salt Technology Facility (CSTF) (10.5.4) and Gas-Systems Technology Facility (GSTF) (10.4.4) with later development in the Components Test Facility.

10.9.5 Task 9.6.1 Status of technology report

A literature search will be carried out with special emphasis on recent enhanced tube development work which would reduce the required heat transfer surface area and the fuel salt inventory requirements.

10.9.6 Task 9.6.2 Define and perform development program

Based on the technology report, a development program will be outlined and carried out to obtain the additional technology necessary for design of a primary heat exchanger for the molten-salt test reactor. Small scale heat transfer studies with enhanced tubes will be made in the Coolant-Salt Technology Facility and Gas-Systems Technology Facility. The effect of gas voids on heat transfer will be studied in the latter.

Table 10.9.2. Schedule for work in Task Group 9.6 - Primary salt-salt heat exchanger development

	Fiscal year				
	1980	1981	1982	1983	1984
9.6.1 Review technology and define program		—			
9.6.2 Heat transfer studies			—	—	

Table 10.9.3. Operating fund requirements for Task Group 9.6 - Primary salt-salt heat exchanger development (costs in 1000 dollars)

	Fiscal year				
	1980	1981	1982	1983	1984
9.6.1 Review technology and define program		60			
9.6.2 Heat transfer studies		20	50	100	
Total operating funds for Task Group 9.6		80	50	100	

10.10 TASK GROUP 9.7 VALVE DEVELOPMENT

The Molten-Salt Reactor Experiment used no valves in salt in the reactor primary system and only small freeze valves in the drain line and in the drain tank system. Larger freeze valves and/or mechanical valves for use in salt will be needed for molten-salt breeder reactors.

10.10.1 Objective

The objective of this task group is to advance high-temperature valve technology sufficiently to enable design of shutoff, throttling, and diversion type valves for MSR applications.

10.10.2 Schedule

The schedule for work on valve development is shown in Table 10.10.2. Work will begin in FY 1978 with preparation of a status of technology report, definition of the development program, and conceptual design of the Valve Test Facility. Detailed design and construction of this facility will be completed during FY 1980. Work will continue through FY 1984 for developing valves as required for the molten-salt test reactor.

10.10.3 Funding

Operating fund requirements for this task group are shown in Table 10.10.3. Capital equipment funds in the amount of \$250,000 will be required in FY 1979 for design and construction of the Valve Test Facility.

10.10.4 Facilities

The Coolant-Salt Technology Facility and the Gas-System Technology Facility will be used for some of the early valve development work; however a separate small facility is needed for use in making preliminary tests on models or prototypes of reactor valves. This facility, known as the Valve Test Facility, will consist of several supply vessels and drain vessels for containing molten salt at temperatures to 750°C, essential auxiliaries, test stands on which the equipment will be mounted, a housing around each test stand, and a common ventilation system. For testing, a valve will be installed in the pipe between a supply vessel and a drain vessel. Transfer of salt between the vessels will be effected by adjusting the cover gas pressures. The vessels, piping, and valves will be heated electrically and will be heavily insulated. Air cooling will be provided for some of the tanks. The tests on the valves will include determination of leakage rates under various conditions of temperature and pressure and investigation of the effects of thermal transients and thermal cycling on

Table 10.10.2. Schedule for work in Task Group 9.7 - Valve development

	Fiscal year								
	1977	1978	1979	1980	1981	1982	1983	1984	1985
9.7.1 Review technology and define program									
9.7.2 Valve development									

Table 10.10.3. Operating fund requirements for Task Group 9.7 - Valve development
(cost in 1000 dollars)

	Fiscal year								
	1977	1978	1979	1980	1981	1982	1983	1984	1985
9.7.1 Review technology and define program		40							
9.7.2 Valve development			100	100	100	100	100	200	
Total operating funds for Task Group 9.7		40	100	100	100	100	100	200	

the valves. The facility will include the instrumentation and controls necessary for operation of the equipment but no special instrumentation for obtaining test data. Cover gas will be supplied from a system common to several facilities and the off-gas will be discharged to a common off-gas system. The valves used in the tests will be provided by the valve development activity. Final testing of larger size valves will be done in the Components Test Facility (10.13) and the molten-salt test reactor mockup (see Section 13).

10.10.5 Task 9.7.1 Status of technology report

This task will involve a literature search and consultation with valve manufacturers and LMFBR personnel to establish present state-of-the-art for high temperature valves and operators as well as a detailed evaluation of experience with freeze valves in the MSR Program.

10.10.6 Task 9.7.2 Define and perform development program

Based on the technology report, a detailed development program will be outlined. Design and construction of the Valve Test Facility will be completed, and work on valve development will be carried out. Two major uncertainties related to valve development involve selection of the plug and seat materials and design and development of high temperature operators. The fabrication of reliable bellows or some other hermetic stem seal, such as the torque-tube seal, must be demonstrated. A commercial capability for fabricating large Hastelloy valves would be developed.

10.11 TASK GROUP 9.8 CONTROL ROD DEVELOPMENT

Control rods that have been conceived for molten-salt breeder reactors represent a marked departure from present technology. In one type, the active section is of graphite, in another it is of metal. In both types, the active section operates in highly radioactive fuel salt at temperatures to 750°C, but the directly coupled rod drives must operate at temperatures below about 200°C.

10.11.1 Objective

The objective of this task is to investigate and develop control rods and control rod drives which meet the safety and other requirements for the molten-salt test reactor. Efforts will be made to use a similar design to that proposed for the molten-salt demonstration reactor in order to reduce duplication of development effort.

10.11.2 Schedule

The schedule for the development of control rods for MSR's is shown in Table 10.11.2. A status of technology report and the conceptual design of the Control Rod Test Facility will be completed in FY 1981. Final design of the facility will be completed in FY 1982, and construction of the facility will be completed during FY 1983. The major portion of the development effort will be done in conjunction with the design of the molten-salt test reactor which will begin in FY 1985.

10.11.3 Funding

Operating fund requirements for this task group are shown in Table 10.11.3. Capital equipment funds in the amount of \$250,000 will be required during FY 1982 for design and construction of the Control Rod Test Facility.

10.11.4 Facilities

As noted earlier, the control rods proposed for the MSBR are markedly different from present technology, and a facility will be required for testing prototypes of MSR-type rods and drives in a simulated reactor environment. No facility exists where such tests could be made, and it will be necessary to construct a rod-test facility.

The Control Rod Test Facility will consist primarily of a rod test thimble, a small molten-salt circulation system and essential auxiliary systems, a test stand on which the equipment will be mounted, a housing around the test stand and a ventilation system. The rod test thimble will simulate the reactor vessel and upper shield structure. Molten salt will be re-circulated through a rod channel formed by graphite pieces in the lower section of the thimble. The rod will be moved in the rod channel by a drive mounted in the upper shield section of the thimble. Appropriate seals in the upper shield section will provide the necessary separation between the environments of the rod and the drive. The reactor section of the thimble and the salt circulation system will be heated electrically and will be heavily insulated. A cooling system will be provided for the upper shield section of the thimble. A drain tank will be provided for the salt. Cover gas will be supplied from a system common to several facilities, and the off-gas will be discharged to a common off-gas system. An instrumentation and control system will be provided for the test facility. The control rods and drives and their instrumentation and controls will be provided by the control rod development activity.

Table 10.11.2. Schedule for work in Task Group 9.8 - Control rod development

	Fiscal year						
	1980	1981	1982	1983	1984	1985	1986
9.8.1 Define development program							
9.8.2 Control rod development							

Table 10.11.3. Operating fund requirements for Task Group 9.8 - Control rod development (costs in 1000 dollars)

	Fiscal year						
	1980	1981	1982	1983	1984	1985	1986
9.8.1 Define development program		60					
9.8.2 Control rod development			60	60	150	150	
Total operating funds for Task Group 9.8		60	60	60	150	150	

10.11.5 Task 9.8.1 Define development program and construct test facility

Most of the work on development of control and safety rods will be directed toward the needs for the molten-salt test reactor. The work in this task will be concerned with preparing a status of technology report, defining a control rod development program, and completing the design and construction of the Control Rod Test Facility.

There has been no experience with control rods operating directly in salt and problems of physical arrangement, cooling and containment must be developed. Drive mechanisms developed for the LMFBR program possibly could be adapted for use in the MSBR control drive system. The "roller nut" concept as depicted by the Marvel Schebler drive by Borg Warner and the "magnetic jack" drive by Westinghouse are possibilities which would be considered because of the design and development already accomplished in support of the LMFBR program.

10.11.6 Task 9.8.2 Perform development program

Most of the work in this task will be associated with development of the drive mechanism and methods for guiding the rods. Shielding and containment will also be considered.

10.12 TASK GROUP 9.9 CONTAINMENT AND CELL HEATING

10.12.1 Objectives

The objective of this task group is to provide sufficient testing of the proposed oven-type heating of the salt-containing systems to determine the constraints which this approach places on maintenance, operation, and instrumentation selection, and to compare its economic impact with that of other containment and equipment heating methods.

10.12.2 Schedule

As indicated on Table 10.12.2, the definition of the development program is divided into two periods, one in FY 1980, and the other in FY 1984. The first period covering FY 1981 and 1982 is for obtaining basic data needed for design. The work in FY 1985 is intended to test detailed design of the primary containment for the molten-salt test reactor.

10.12.3 Funding

Operating fund requirements for this task group are given in Table 10.12.3. These figures, especially those shown in FY 1984 and 1985, should be considered preliminary. Capital equipment funds in the amount of \$77,000 will be required during FY 1981.

Table 10.12.2. Schedule for work in Task Group 9.9 – Containment and cell heating

	Fiscal year							
	1979	1980	1981	1982	1983	1984	1985	1986
9.9.1 Define development program								
9.9.2 Carry out development work								

Table 10.12.3. Operating cost requirements for Task Group 9.9 – Containment and cell heating (costs in 1000 dollars)

	Fiscal year							
	1979	1980	1981	1982	1983	1984	1985	1986
9.9.1 Define development program		60				100		
9.9.2 Carry out development work			100	60			50	
Total operating costs for Task Group 9.9		60	100	60		100	50	

10.12.4 Facilities

Preliminary development of various items will be done on an individual basis but the oven-type heating and containment system will be tested in the molten-salt test reactor mockup (see Section 13).

10.12.5 Task 9.9.1 Define development program

Although the containment philosophy and the idea of using the cell as an oven appears straight forward, these need to be studied carefully in order to uncover any uncertainties and to define a program to resolve these. The HTGR experience will be fully utilized.

10.12.6 Task 9.9.2 Perform development program

This task involves the accomplishment of the work outline above.

10.13 TASK GROUP 9.10 COMPONENTS TEST FACILITY

10.13.1 Objectives

The objective of this task group is to provide a location equipped with the necessary services and utilities to permit development and testing of large-scale reactor components and systems under design conditions as well as unusual operating conditions. A 30-MW MSR steam generator model will be tested which will produce steam at temperatures and pressures proposed for the test reactor. Information will be obtained on various items including the startup procedures, the overpressure protection system, and the steam-leak detection system. A prototype pump will be tested to obtain information on factors including the flow characteristics and the effects of temperature transients. Large-scale valves, cold traps, core components, heat exchangers, tritium management schemes, etc. will be tested under all conditions which are likely to be encountered in an operating reactor. Development of some components will be carried out concurrently in a single development facility, while others will require individual facilities.

This work cannot be done in existing facilities, due to the large space requirements. For instance, the steam generator model will be about 145-ft high, a 30-MW salt heater will be needed, and large cooling towers will be required for a heat sink.

The CTF is intended primarily for the development and testing of components associated with the test reactor. However, the facility design will be such that it could be modified or expanded for use in additional component development for a demonstration reactor.

Although some components to be tested in the Components Test Facility will be full scale, additional prooftesting of all components will be carried out in the molten-salt test reactor mockup. This system will be a full-scale integrated facility having a configuration similar to that of the molten-salt test reactor. However, it will operate isothermally and only slow temperature transients will be possible.

10.13.2 Schedule

As indicated in Table 10.13.2, conceptual design of the Components Test Facility begins in FY 1978 and construction will be complete by FY 1982.

10.13.3 Funding

Operating fund requirements for this task group are shown in Table 10.13.3.1. Authorization of funds to cover the design and construction of the CTF will be required in early FY 1980. A preliminary estimate of the cost of the basic facility in which test systems would be located is \$10 million; however, no detailed design and cost analysis has been carried out for obtaining this estimate. Capital equipment fund requirements for this task group are shown in Table 10.13.3.2.

10.13.4 Facilities

The Components Test Facility will consist of a location that is sufficiently large to house the Steam Generator Model Test Stand and the Prototype Pump Test Stand, as well as individual test facilities for large-scale components such as valves, control rods, and core components. A large electrical power supply will be installed to operate pumps and other equipment and to provide electrical heating for salt-containing lines and components. A ventilation system will be provided with adequate filtration and air cleanup to assure containment of hazardous materials including beryllium-containing compounds and BF_3 . Cooling water and other utilities will be installed, as well as general-purpose modular instrumentation. Computer systems for recording and analyzing data will also be included. An early activity associated with the conceptual design of this facility will be to survey potential space for housing the facility, and to complete the conceptual design of a building if suitable space is not available.

10.13.5 Task 9.10.1 Conceptual design of the facility

In this task compilations will be made of all components and systems to be tested, the type of test to be made, the utilities, salt requirements, and other pertinent information in order to complete a conceptual design. This facility will be used to test large-scale steam generators, pumps, valves, heat exchangers, and other components. Adequate electrical supply

Table 10.13.2. Schedule for work in Task Group 9.10 - Components Test Facility

	Fiscal year									
	1977	1978	1979	1980	1981	1982	1983	1984	1985	1986
9.10.1 CTF conceptual design										
9.10.2 CTF final design										
9.10.3 CTF construction										
9.10.4 CTF operation										

Table 10.13.3.1. Operating fund requirements for work in Task Group 9.10 -
Components Test Facility
(costs in 1000 dollars)

	Fiscal year									
	1977	1978	1979	1980	1981	1982	1983	1984	1985	1986
9.10.1 Conceptual design		120	80							
9.10.2 CTF final design				150	50					
9.10.3 CTF construction				50	150	100				
9.10.4 CTF operation						245	725	1610	2300	
Total operating funds for Task Group 9.10		120	80	200	200	345	725	1610	2300	

Table 10.13.3.2. Capital equipment fund requirements for Task Group 9.10 -
 Components Test Facility (costs in 1000 dollars)

	Fiscal year				
	1982	1983	1984	1985	1986
9.10.4 Miscellaneous equipment and instrumentation	75	411	579	1023	
Total capital equipment funds for Task Group 9.10	75	411	579	1023	

will be provided for operating large loops. Filtered exhaust systems, overhead cranes, and modular instrumentation and heater controls will be installed to accommodate various types of development.

This task consists of (1) establishing criteria for the CTF, (2) preparing a safety analysis and environmental statement, (3) developing a preliminary layout and design for the CTF, including instrumentation and controls, (4) preparing a cost estimate for the project, and (5) preparing and submitting a long form construction project data sheet for FY 1980 authorization.

10.13.6 Task 9.10.2 Title I and Title II design of the facility

Title I design of the facility will begin after project authorization in FY 1980 and Title II design will be completed during early 1981. Operating fund requirements during design of the facility cover personnel including the program and project engineers, design work not covered by capital project funds, estimating, and liaison between program and project activities.

10.13.7. Task 9.10.3 Construction of the facility

Construction will begin in mid FY 1980 and will continue until late FY 1982. Operating funds are required for support of the program and project engineers.

10.13.8 Task 9.10.4 Operation of the facility

Operation of the facility will begin in late FY 1982 and will continue for an indefinite period. The initial activity will be associated with the requirements for the MSTR, however, the later work will be in support of subsequent reactor component development requirements.

REFERENCES FOR SECTION 10

1. ORNL-TM-3030, *MSRE Systems and Components Performance by Molten-Salt Reactor Experiment Staff*, edited and compiled by R. H. Guymon, June 1973.
2. C. H. Gabbard, *Development of a Venturi-Type Bubble Generator for Use in the Molten-Salt Reactor Xenon Removal System*, ORNL-TM-4122, December 1972.
3. C. H. Gabbard, *Development of an Axial-Flow Centrifugal Gas Bubble Separator for Use in MSR Xenon Removal Systems*, ORNL-CF-72-12-42, December 1972.

4. ORNL 4812, *The Development Status of Molten Salt Breeder Reactors*, M. W. Rosenthal, P. N. Haubenreich, and R. B. Briggs, August 1972, p. 412.
5. P. N. Haubenreich, *A Review of Production and Observed Distribution of Tritium in the MSRE in Light of Recent Findings*, ORNL-CF-71-8-34, August 23, 1971.
6. ORNL-TM-3039, *MSRE Systems and Components Performance by Molten-Salt Reactor Experiment Staff*, edited and compiled by R. H. Guymon, June 1973, p. 292.
7. Ibid, p. 133.
8. E. G. Bohlman, "Heat Transfer Salt for High Temperature Steam Generation" ORNL-TM-3777, December 1972.
9. C. N. Spalaris et al., *Materials for Nuclear Superheater Applications*, GEAP-3875 (1962).
10. *Evaluation of a 1000 MWe Molten-Salt Breeder Reactor*, Technical Report of the Molten-Salt Group, Part II, Ebasco Services, Inc., October 1971, p. 118.
11. *1000 MW(e) Molten Salt Breeder Reactor Conceptual Design Study*, Final Report - Task I, Ebasco Services Inc., February 1972, p. 5-1.
12. O. W. Burke, *Hybrid Computer Simulation of the MSBR*, ORNL-TM-3767 (May 1972).
13. J. L. Crowley, "MSRP Steam Generator Development Bases", ORNL CF-72-12-43, December 1972.
14. J. L. Crowley, R. E. Helms, and J. P. Saunders, "Conceptual System Design Description of the Steam Generator Tube Test Stand for the MSRP," October 1970.
15. P. G. Smith, *Experience with High-Temperature Centrifugal Pumps in Nuclear Reactors and their Application to Molten-Salt Thermal Breeder Reactors*, ORNL-TM-1993 (September 1967).
16. *Conceptual Design Study of a Single-Fluid Molten-Salt Breeder Reactor*, ORNL-4541 (1971).
17. A. G. Grindell, W. F. Boudreau, and H. W. Savage, *Nucl. Sci. Eng.* 7: 83-91 (1960).
18. Oak Ridge National Laboratory, Reactor Div. Job Spec. M-10544-RB-001-X-1 (July 21, 1969).
19. *Feasibility Study of Rotor-Bearing System Dynamics for a 1250 hp Molten-Salt Fuel Pump*, MTI-68TR9, Mechanical Technology, Inc., (April 12, 1968).
20. R. C. Robertson, *MSRE Design and Operations Report, Part I, Description of Reactor Design*, ORNL-TM-728 (January 1965), p. 162.
21. C. H. Gabbard, *Reactor Power Measurement and Heat Transfer Performance in the Molten Salt Reactor Experiment*, ORNL-TM-3002, May 1970.

22. *MSR Program Semiann. Progr. Rept. Aug. 31, 1971*, ORNL-4728, p. 152.
23. C. E. Bettis et al., *Design Study of a Heat Exchanger System for One MSBR Concept*, ORNL-TM-1545 (September 1967).
24. C. E. Bettis et al., *Computer Programs for the Design of MSBR Heat Exchangers*, ORNL-TM-2815 (1970).
25. R. C. Briant, A. M. Weinberg, E. S. Bettis, W. K. Ergen et al., *Nucl. Sci. Eng.* 2: 797.
26. R. C. Robertson, *MSRE Design and Operations Report, Part I, Description of Reactor Design*, ORNL-TM-728 (January 1965).
27. J. P. Sanders, *A Review of Possible Choices for Secondary Coolant for Molten-Salt Reactors*, internal memorandum, August 6, 1971.
28. A. N. Smith, *Experience with Fluoroborate Circulation in an MSRE Scale Loop*, ORNL-TM-3344 (September 1972).
29. J. W. Koger, *MSR Program Semiann. Progr. Rept. Aug. 31, 1970*, ORNL-4622.
30. W. R. Huntley, *MSR Program Semiann. Progr. Rept. Aug. 31, 1971*, ORNL-4728.
31. *Conceptual Design Study of a Single-Fluid Molten-Salt Breeder Reactor*, ORNL-4541 (1971).
32. Adams, R. E., Browning, W. E. Jr., and Ackley, R. D., "Containment of Radioactive Fission Gases by Dynamic Adsorption," *Industrial and Engineering Chemistry* 51: 1467-1470 (December 1959).
33. FSDD for an MSR Coolant-Salt Technology Facility (CSTF) (EJN 10578) ORNL-CF-72-6-17 (6-30-72).
34. R. B. Korsmeyer, "The Effect of Hydrogen Back-Diffusion on the Transport of Tritium in an MSBR," ORNL-CF-71-5-10 (May 1971).
35. R. B. Briggs, "The Effect of Oxide Coatings and Molten Salt Fibers on the Permeation of Hydrogen Through Metal Walls," ORNL-CF-73-1-26 (January 1973).
36. H. D. McLain, "The CSTF Deuterium Experiment for the MSR Program," MSR-73-16 (January 1973).
37. *MSR Semi-Annual Progr. Report. P/E 2/8/69*, ORNL-4396 (1969).

11. MAINTENANCE

11.1 INTRODUCTION

The maintenance of all reactors requires the performance of various mechanical operations on equipment which, because of radioactive contamination and activation, is not directly accessible to maintenance personnel. Depending upon the level of activity, the size of equipment, and the design provisions for maintenance, anything from simple local shielding to fully remote manipulation may be required. The time required to do maintenance and the cost of the maintenance provisions increase with the degree of remoteness required.

The circulating-fuel reactor has fission products and intense radiation to contend with not only in the reactor vessel but also in all of the primary circuit through which the fuel salt circulates, the off-gas system, and in the fuel processing plant. Thus the circulating-fuel reactor requires radioactive maintenance of a greater scope than does a fixed-fuel reactor. On the other hand, the refueling operation is simpler, the radioactivity is retained on-site within one containment, and the necessity of a separate maintenance organization and equipment for a fuel reprocessing plant at another site is avoided.

Although maintenance design efforts cannot affect the size and activity level of the components in a reactor, much can be done in the design stages of a plant to influence strongly the degree of accessibility and the complexity of the maintenance operation. The maintenance concept for an MSBR is characterized by the following general principles:

1. Each system is composed of manageable units joined by suitable disconnects and lines which can be cut and rewelded remotely.
2. Each unit is accessible and replaceable from directly above through removable shielding.
3. Failed units are removed and replaced.

Much of the maintenance experience on which this concept rests resulted from application of this approach to the MSRE. Only the simplest of inspections and repairs could be done on failed equipment for the MSRE; however, in an MSBR economic considerations will dictate consideration of more extensive repair capabilities.

11.1.1 Objective

The objectives of work in this activity are to develop the technology required for maintaining those portions of an MSBR which require remote or semiremote maintenance techniques, and to obtain improved estimates of the impacts of maintenance on the economic and nuclear performance of MSBRs. The work in this activity will interface strongly with that in Reactor Design and Analysis (Section 8).

11.1.2 Scope

The scope of work in this activity consists of the consideration of remote maintenance requirements during the preliminary and conceptual design of molten-salt reactors (including the 1000-MW(e) reference design MSBR, a demonstration reactor, and a test reactor), the development of the remote maintenance technology required by these reactors, and the development of equipment and techniques for remote inspection of welds. Consideration of in-service inspection of all types also falls within the scope of this activity.

11.2 PROGRAM BUDGET AND SCHEDULE

11.2.1 Schedule and key program milestones

A summary schedule for work on development of MSBR remote maintenance technology is shown in Table 11.2.1.1. The key milestones for work on MSBR maintenance are given in Table 11.2.1.2 and occur at the times shown in Table 11.2.1.1.

11.2.2 Funding

Operating fund requirements for work on MSBR maintenance are summarized in Table 11.2.2.1, and capital equipment fund requirements are summarized in Table 11.2.2.2.

11.3 REQUIREMENTS, BACKGROUND, AND STATUS OF DEVELOPMENT

11.3.1 Technological background

During the past 15 to 20 years, the nuclear industry has acquired a great deal of experience in the maintenance of radioactive systems. Some has come from having to make repairs under very difficult conditions. A few such jobs have necessitated undesirable exposure to personnel; others have required ingenious devices and very long times to accomplish. Although these feats have been instructive, they are not models to follow. The goal in designing a reactor is not only to make maintenance possible, but to make it as sure, as safe, and as economical as it can be. The experience that points the way to this objective is that acquired with those plants in which maintenance was planned, provided for, and uneventfully carried out despite high levels of radioactivity. There has been experience of this sort in various USAEC installations, both with reactors and with chemical processing plants, that provides a broad technological basis for developing the maintenance system for an MSBR.

At ORNL, four circulating-fuel reactors (ARE, HRE-1, HRE-2, and MSRE) have been operated, as well as processing facilities of various kinds. Although the level of radioactivity varied, they all contained complex systems for circulating, processing, and storing radioactive materials whose activity levels denied direct access. The need for maintenance was recognized in advance, and maintenance provisions were made in their design. Development programs also included maintenance planning and practice. The preparations for maintenance of the MSRE, the organization, and the conduct of the maintenance operations actually performed on the MSRE are described in reference 4 and the MSR Program semiannual progress reports from 1967 through 1971.

11.3.1.1 Preparations for MSRE maintenance

Preparations for maintaining the MSRE began with the involvement of maintenance specialists in the design, and continued through the construction and startup phases.⁴ The first scheme visualized for the MSRE featured a bridge-mounted manipulator, operated in an enclosed space above the reactor cell and controlled remotely with the aid of television. (A maintenance development facility including a manipulator, viewing devices, and equipment mockups had been used at ORNL to show the feasibility of this approach.) Smaller jobs in the MSRE were to be done by the semi-remote technique proved in the HRE-2, using simple, long-handled tools manipulated by hand through small penetrations in a portable shield set up over an opening in the cell's concrete roof. Design and planning soon showed that the maintenance work anticipated in the MSRE could be done in this simpler way, and the manipulator idea was set aside.

The MSRE portable maintenance shield was a set of tracks and several 12-in.-thick steel slabs, with holes for tools and viewing devices, that rolled on the tracks. Inserts for the holes included shielding windows, lights, and split bushings to fit around tool shafts. When very free tool movement was required, bags of steel shot around the shaft blocked the radiation. Lifting devices permitted the remotely controlled building crane to remove shield blocks or major equipment items. Each removable item had a bail at the center of gravity or other provisions to simplify lifting. Guides were provided where necessary to steer replacement parts into place. To ensure proper fit, jigs were built for all of the major replaceable components. The 5-in. salt lines were provided with flanges that used frozen salt as a barrier to keep molten salt away from the ring gasket. Machines were developed (and fixtures installed in the cell for them) that could cut the 1-1/2-in. lines to the drain tanks, prepare the ends, bring old and new pieces together, and join them by brazing. The only tools required for most operations were simple, long-handled hooks, wrenches, and clamps characterized by their reliability rather than by their versatility.

During the installation of the reactor equipment and the prepower testing, many of the maintenance provisions were tested. All of the primary loop was assembled on a large jig before going into the cell and optical

Table 11.2.1.1. Schedule for work on development of MSBR remote maintenance technology

	Fiscal year									
	1977	1978	1979	1980	1981	1982	1983	1984	1985	1986
10.1 Consideration of remote maintenance during preliminary and conceptual design			▽a	▽b	▽c	▽d				
10.2 Development of remote maintenance technology			▽e		▽f	▽g				
10.3 Development of technology for post weld inspection				▽h	▽i					

Table 11.2.1.2. Key milestones for development of MSBR remote maintenance technology

Milestone	Description
a	Complete survey of MSBR maintenance requirements.
b	Complete determination of maintenance requirements for MSBR components. Complete determination of maintenance requirements for demonstration reactor.
c	Determine maintenance-related design restrictions and complete evaluation of impacts on MSBR performance.
d	Complete determination of test reactor maintenance requirements and tabulate overall maintenance requirements for MSRs.
e	Complete survey and development plans for remote pipe cutting, remote seal weld cutting and welding, remote pipe spreading and alignment technology, and remote pipe welding techniques.
f	Complete survey and development plans for improved viewing devices.
g	Complete maintenance development related to design of test reactor.
h	Complete survey for adaptation of customary weld inspection techniques to MSBR maintenance.
i	Determine potential for application of advanced weld inspection methods to MSBR maintenance and complete development plans.

Table 11.2.2.1. Operating fund requirements for development of MSBR remote maintenance technology
(costs in 1000 dollars)

	Fiscal year									
	1977	1978	1979	1980	1981	1982	1983	1984	1985	1986
10.1 Consideration of remote maintenance during preliminary and conceptual design		50	100	50						
10.2 Development of remote maintenance technology			80	336	650	497	448	436	385	
10.3 Development of technology for post weld inspection			20	100	141	100	70	50	50	
Total operating funds for remote maintenance technology		50	200	486	791	597	518	486	435	

Table 11.2.2.2. Capital equipment fund requirements for development of MSBR
remote maintenance technology
(costs in 1000 dollars)

	Fiscal year							
	1977	1978	1979	1980	1981	1982	1983	1984
10.2 Development of equipment for remote maintenance		200	85	80	50	90	55	
10.3 Development of equipment and techniques for post-weld inspection			20	20	15	10	10	
Total capital equipment funds for maintenance technology		200	105	100	65	100	65	

tooling was used to locate reference points in the cell precisely. Maintenance items that were tested included the crane, lifting and viewing devices, and the various types of disconnects. Freeze flanges were opened and closed; a cell-space cooler, the control rods, rod drives and a core-sample array were removed and replaced; the primary heat exchanger and fuel pump bowl were installed using in part the remote maintenance provisions. After the nuclear startup experiments the fuel pump rotary element was removed, inspected and reinstalled. During this time personnel were trained and procedures were perfected.

11.3.1.2 Extent of MSRE experience

The semi-remote jobs that were accomplished in the reactor and drain tank cells during the 4-1/2 years of nuclear operation are summarized in Table 11.3.1.2. With the exception of those carried out in 1965 (before high-power operation), all of the jobs involved components that were located in radiation fields of several thousand R/hr. The radioactivity of the items that were removed varied widely; some, such as the specimens that were removed from the core 5 to 7 days after shutdown, read several hundred R/hr at several feet. All of the jobs involved use of the remote-maintenance control room, at least for setting up and removing the maintenance shield. The cell-top membrane was cut, welded, and inspected each time maintenance was done.

In addition to the maintenance in the reactor and drain-tank cells, there were several jobs involving highly radioactive components in other parts of the building. Valves and filters in the off-gas system were removed and replaced, and heaters were installed on the inlets of the off-gas charcoal beds. The fuel-sampler drive mechanism had to be repaired on several occasions, which required that a temporary wood-and-plastic containment enclosure be set up inside the reactor building.

The post-operation examinations carried out between November 1970 and February 1971 involved viewing in the core and in the fuel pump, cutting out several parts of the fuel salt system, and plugging some lines.⁵ The general technique was the same as was used in maintaining the reactor: long-handled tools through the maintenance shield. Some of the tools were quite different, however, to handle the special tasks.

The control rods and drives were removed, the 10-in. core-access plug with the rod thimbles was taken out, and a section of rod thimble was cut off with a grinding wheel. A grinding wheel, mounted on a special tool, was also used to cut through the pump tank around the sampler cage so that it could be removed. An 11-in. section of the heat exchanger shell was cut out with a plasma torch, then sections of six tubes were cut with an abrasive cutoff tool and removed for inspection. Examination showed that, as suspected, a small amount of salt (~ 2 in.³) had leaked near a freeze valve in a drain line. The freeze valve and adjacent piping was cut out and removed. The holes in the pump tank and the heat exchanger shell were patched, the latter by welding, and plugs were installed in the severed ends of the drain lines.

Table 11.3.1.2. Semi-remote work in MSRE reactor and drain cells after beginning of nuclear operation^a

Remove, inspect, replace fuel-pump rotary element (9/65)

Inspect core and reactor vessel, remove broken graphite (9/65)

Remove and/or replace core sample array (9/65, 9/66, 5/67, 4/68, 6/69, 12/69)

Remove flow restrictor in equalizer line in reactor cell (2/66)

Install thermocouple on off-gas line in reactor cell (3/66)

Install and remove temporary heater on gas lines at FP (8-9/66, 11/66)

Rod out off-gas line at fuel pump exit (11/66, 4/68, 12/68)

Replace fuel pump off-gas jumper line (9/66, 12/66, 4/68)

Replace overflow tank vent line (6/69)

Install permanent heater on off-gas line at fuel pump (6/69)

Remove and replace control-rod drive (9/66, 5/67, 4/68, 1/69, 6/69)

Replace control rod (9/66, 6/69)

Remove, inspect, reinstall control rod (1/69)

Remove, repair, reinstall heaters on primary HX (3-4/68)

Replace reactor cell space cooler motor (6/65)

Remove, repair leaks, replace reactor cell space cooler (8-9/66)

Replace reactor cell space cooler (5/67)

Replace air-line disconnects in reactor cell and drain cell (1/67, 7/69)

Remove, repair, replace air control valve in reactor cell (12/66)

Measure gamma spectra from components in reactor cell (5/67, 4/68, 6/69, 11/69)

Visually scan reactor cell (5-6/67, 2/68)

Visually scan drain cell (6/67)

Install and remove sampler-enricher on drain tank (8-9/68)

^aLow-power experiments began in June 1965; high-power operation in April 1966.

11.3.1.3 Significance of MSRE maintenance experience

Although the major components of the fuel system, whose replacement would have been more complicated than any job that was done, required no maintenance, the MSRE experience was sufficient to thoroughly test the general maintenance strategy and many of the specific design features.

The MSRE maintenance system was reliable: no job arose that could not be done. An important factor was the flexibility of the maintenance system which allowed obstacles to be circumvented and unforeseen jobs (such as those in the off-gas system) to be accomplished.

The experience with the MSRE emphasized that the payoff for preparation is tremendous in the case of radioactive maintenance. Jobs such as replacing the core specimens went very quickly compared to others that were basically less difficult, but for which no special provisions had been made.

Especially valuable information on fission-product contamination came from the MSRE experience. Noble gases behaved predictably and could be purged before systems were opened. Salt-seeking fission products were no problem — the salt drained cleanly and any that was trapped froze and retained the fission products. There was no corrosion film or scale to flake off and become airborne. At least part of the noble metals that deposited on surfaces in the off-gas system were fairly easily transferable, but particulate contamination was generally confined to the tools, which were swabbed and bagged as they were pulled from the shield. Iodine that was produced by the decay of tellurium on surfaces soon appeared in the air in the reactor cell. Ventilation air from the reactor building and from the containment cells was passed through particulate filters and up a stack. The greatest amount of activity discharged in any week was less than 0.2 Ci (mostly iodine) and occurred during work on the off-gas system.

Although radiation levels in the reactor cell were typically on the order of several thousand R/hr while maintenance work was going on, the general background to which workers were exposed while manipulating tools was only about 0.01 R/hr. Procedures were planned to minimize personnel exposure in locally higher radiation fields and the work was never seriously inconvenienced by having to rotate workers. No maintenance worker ever received more than the normal limit of 3 rem in any quarter.

11.3.2 MSBR maintenance requirements

In designing and planning for the maintenance of the MSBR, the experience with the MSRE and other radioactive systems has been evaluated and adapted to the extent possible. The maintenance system for the reference MSBR is discussed in some detail in ORNL-4541.⁶

11.3.2.1 Classes of maintenance

MSBR maintenance requirements fit into the following four general classes.

Class I - Permanent Equipment. This category contains all items which can reasonably be expected to require no maintenance during the design lifetime of the plant. Examples are the reactor vessel, the pump vessels, primary heat exchanger shells, the fuel-salt drain tank, thermal shielding, thermal insulation, the connecting process piping, etc. No special provisions are included for maintenance of these items. Emergency maintenance to some extent is possible, however, because of the access that is provided primarily for in-service inspection.

Class II - Equipment Allowing Direct Maintenance. This group includes the items which can normally be approached for direct maintenance within a reasonable period of time (typically after the secondary salt has been drained and flushed and the remaining activities allowed to decay for about ten days). The steam generators, reheaters, coolant-salt pumps, and the equipment in the heat rejection cell fall into this class. In the unlikely event that one of these components did become highly contaminated with fission products, its removal would be treated as a Class III or IV item, discussed below. Once the sources of activity were removed from the cell, cleanup and component replacement could proceed in the normal fashion using direct maintenance.

Class III - Equipment Requiring Semidirect Maintenance. Much of the equipment in the off-gas and chemical processing cells, such as pumps, blowers, valves, processing vessels, filters, etc., will become radioactive. In general, the sizes of these items are comparable to the MSRE equipment. MSBR radiation levels may be a factor of 10 higher than in the MSRE, however. The maintenance tools for this class of equipment could be similar to those for the MSRE, but the shielding and containment provisions would have to be more effective because of the more intense sources of radiation.

Class IV - Large Equipment Requiring Remote Maintenance. This group includes items which are clearly beyond present experience because of a combination of size, radiation level, afterheat removal, and disposal considerations. Examples are the pump rotary element, the primary heat exchanger tube bundle, and the core graphite.

The reactor primary system, because of the large size of the highly contaminated equipment, presents the greatest problems in containing the radioactivity and dealing with afterheat and is therefore used as the basis for the discussion which follows.

11.3.2.2 Containment considerations

Although the fuel salt and highly radioactive gases will be removed from any system before it is opened for maintenance, the reactor primary system will still contain large amounts of radioactivity, some of which will be transferable. The MSBR building and cells and the maintenance equipment and procedures must, therefore, be designed so as to limit the spread of radioactive material within the reactor building and to prevent more than trivial amounts from being released outside the building during maintenance.

The fission-product decay heating and the amounts of short-lived activity that must be dealt with decrease rapidly during the first few days after cessation of power operation. For this reason, it is unlikely that the primary system will be opened sooner than ten days after full-power operation is stopped.

Ten days after shutdown from sustained operation at 2250 MW(t), the noble-metal fission products on surfaces may total about 2.2×10^8 curies, or roughly 3×10^5 Ci per ft² of metal surface that had been exposed to the fuel salt. (This figure is based on the assumption that 75% of the noble metals deposit on metal surfaces in the loop.) The deposited tellurium will be generating iodine, some of which will go into the gas or air contacting the surface. At 10^6 sec (11.6 days) the calculated total rate at which 2.3-hr ¹³²I is generated from 78-hr Te on surfaces is 2×10^6 Ci/hr or about 30 Ci/hr per ft² of surface in the fuel circulating system. Eight-day ¹³¹I will be generated on surfaces at a total rate of about 5 Ci/hr or 7×10^{-5} Ci/hr per ft².

The noble gases in the graphite after 10 days could amount to as much as 1.2×10^6 Ci (almost all ¹³³Xe), assuming none diffused out during the cooling period. The radioactive daughters of noble gases in the graphite would likely range up to 1×10^7 Ci.

The inventories of the fission products that dominate at 10 days after shutdown may be as much as 170 times those in the MSRE. (This factor may be considerably lower if the MSBR gas-stripping system removes a substantial fraction of the noble metals.) The amounts per unit area should be less than 5 times as great as in the MSRE, however.* Thus the observed behavior of the deposited fission products in the MSRE should be rather similar to that to be expected in the MSBR.

* For the shortlived noble metals that are dominant a few days after shutdown, the intensity on fuel loop surfaces is nearly proportional to the ratio of power to loop surface area. For the reference MSBR, this is $2.25 \times 10^6 / 5.2 \times 10^4 = 43$ kW/ft²; for the MSRE the ratio was $7.4 \times 10^3 / 8.5 \times 10^2 = 9$ kW/ft².

Based on the MSRE experience, we expect that the noble metals on surfaces will be more or less adherent, depending on whether they are on surfaces in the salt loop or in the off-gas system, but that care must be used to avoid knocking or scraping them off. Although there was uncertainty in the fraction of the surface-generated iodine that was released into the gas in the MSRE, it is clear that in the MSBR measures must be provided that are adequate to deal with all of the iodine so generated. The noble-gas daughters in the graphite will not be readily transferable, and should cause no contamination problem.

The MSBR building and equipment layout are intended to permit safe containment of the radioactivity during maintenance. Before maintenance is started, the fuel salt will be secured in the drain tank. (Normally it will be circulated for several days to help remove afterheat before it is drained.) The system requiring maintenance will then be purged of radioactive gases and, if necessary, cooled down. The containment cell will then be unsealed and a maintenance shield set up. The cell will be maintained at a slight negative pressure by an air exhaust system. Tools and other items penetrating the maintenance shield will be sealed to the shield so as to minimize air leakage into the cell. (Boots or gas-buffered seals might be used.) Primary systems will not be left open to the cell longer than necessary; if an equipment item cannot be replaced immediately a temporary closure will be applied in order to minimize both the radioactive contamination of the cell and the ingress of oxygen and moisture into the system. When contaminated items are removed through the shield, they will be withdrawn into casks through openings equipped with valves or flanges that will close the reactor cell and the cask except during the transfer. Generally, the gas streams passing through the cell will be filtered, passed through absorbers and recirculated. Any excess gas will be stripped of radioactivity before it is discharged to the atmosphere. Items removed from the primary system will be repaired or prepared for disposal in a hot cell where similar precautions must be observed. All operations will be carried out inside the reactor building to assure complete containment.

The assurance of public protection during maintenance is comparable to that during operation, although the lines of defense are different. During operation, the fuel salt and highly radioactive gases are circulating within the vessels and piping, which are in turn doubly contained, being inside sealed cells inside the reactor building. During maintenance, the fuel salt with most of the fission products will be sealed in the drain tank, and the precautions that ensure that it will not be brought out during the maintenance operations constitute primary containment for it. Any system to be opened will be drained and purged so that when it is finally opened, the amount of radioactivity that could conceivably escape into the cell will be far less than that circulating (and liable to being spilled through a pipe rupture in the design-basis accident) during operation. The first line of defense ("primary containment") for this limited amount of radioactivity is the ventilation system that maintains the cells at a negative pressure and removes any radioactive contaminants from the exhaust stream before it is discharged into the reactor building. Secondary containment during maintenance is the same as during operation — the sealed reactor building.

11.3.2.3 Afterheat considerations

The fission products that will remain in the graphite and on surfaces in the fuel system will produce significant heating in the large equipment items while maintenance operations are going on. This must be taken into account in the provisions for the major operations: replacement of the core graphite, the tube bundle of a primary heat exchanger, and perhaps the rotary element of a primary pump.

It is estimated that 10^6 seconds (11.6 days) after shutdown from 2250 MW(t) the total heat generation rate in the primary system would be 770 kW, consisting of 210 kW in the graphite of the core, 125 kW in each of the four primary heat exchangers, and 60 kW distributed over the other surfaces. What the temperature in the primary system must be before it is opened has not been determined. With the cell cooling system that is envisioned, the fuel system temperature 10 days after a shutdown would likely be in the range of 500 to 1000°F. If further study of the maintenance procedures indicates that this would be unacceptable, additional heat removal must be provided, additional time allowed to reach a satisfactory temperature, or more likely, local cooling would be employed to lower the temperature at the point of critical operations to 200 to 400°F. Some cooling must be continued while the item is being removed, but the rate of temperature rise in the absence of cooling would be low - 30°F/hr for a heat exchanger bundle and 2.4°F/hr for the graphite core. The temperatures of the piping and rotary element of the pump would rise even more slowly.

11.3.2.4 Graphite replacement

Because of neutron irradiation damage, it will be necessary to replace the core graphite several times during the life of an MSBR plant. Consideration of the effects on breeding and possibly on power distribution leads to removal of the graphite while it is still structurally sound. Thus, although the removal procedure must be capable of dealing with broken graphite elements, the strength of the graphite should not hamper its removal.

In the ORNL reference MSBR,⁶ the upper head of the reactor vessel and the entire core (176 tons of graphite and 97 tons of metal) are replaced as a unit. This constitutes by far the largest maintenance task in this conceptual design, and explains some important features of the building layout and equipment. The major item of special maintenance equipment required for the core replacement is a 20-ft-diam × 40-ft-high shielded transport cask. The carbon steel walls of the cask are about 2 in. thick, which is sufficient to reduce the radiation level on contact with the outside of the cask to about 1000 R/hr and at the outside wall of the reactor containment vessel to less than 0.1 R/hr after a 10-day decay period for the core. Conservative estimates indicate that the 210 kW of heat being generated in the core can be safely dissipated through the cask wall so that no cooling system for the cask will be required. The reactor core assembly is prepared for removal in a

semidirect fashion through a work shield. The lifting of the core assembly into the transport cask and transport to the spent-core storage cell, the installation of the new core assembly, and the replacement of the shielding are accomplished from the remote maintenance control room in the same fashion as the removal and replacement of large items of MSRE equipment.

Ebasco Services and their associates in an industrial design study carried out under subcontract to ORNL questioned the desirability and practicality of replacing the core graphite as a unit. They investigated making the core of individually replaceable elements, and decided that 15-in. hexagonal elements were the optimum.⁷ Some of the graphite elements would be replaced at 4-year intervals, during major turbine-generator overhauls. Adoption of this scheme would obviously greatly alter the requirements for handling tools and casks for the exposed graphite; however, additional work is necessary for demonstrating the feasibility of this approach.

11.3.3 Status of development work

As stated earlier, the MSBR maintenance concept depends upon access from above, a system of replaceable units, appropriate disconnects and tools to operate them, and lines which can be cut and rewelded remotely. Thus, it is clearly essential that maintenance design and development be concurrent with plant design. This has been the case in the conceptual studies to date. The maintenance techniques for fluid-fuel reactors have evolved as the size, complexity, and radiation levels of the reactors have increased. Design studies have not indicated any insurmountable problem in maintaining a 1000-MW(e) MSBR, and no serious conflicts have arisen in imposing the maintenance requirements on the reactor system.

Most of the techniques and many of the tools have been developed. Several flexible maintenance shields have been built and used. Optical viewing equipment — window inserts, periscopes, adequate lighting — all are available. The use of a shielded maintenance control room with windows, remotely-operable TV, and remotely-controlled crane and tooling has been successfully demonstrated. Remotely-operable disconnects for electrical power, instrumentation, and service piping are at a satisfactory state of development. The remote fabrication of brazed joints in small system piping has been demonstrated in connection with the MSRE.²

Two important techniques that are requisites for maintaining large power reactors are not available, however. They are remote welding and post-maintenance inspection.

It is highly desirable from the standpoint of reliability that the MSBR fuel circulation system be of all-welded construction. Thus, remote cutting and rewelding of the system piping will be required in the replacement of major components. The status of remote welding as of 1969 and the required development program were presented in reference 8.

A portion of that program has been accomplished and the present generation of automatic welding machines are reliable and capable of making high-quality welds.⁹ These machines are not now capable of fully remote welding, but appear to be adaptable to this purpose.

The provisions in the MSBR for access to equipment for maintenance operations are equally applicable to in-service inspection. The state-of-the-art of remote inspection of welded joints is reviewed in reference 10. Dependable application of common methods for nondestructive inspection of welds is difficult or impossible in high-temperature, high-radiation fields. Some methods promise to be successful, however, and current AEC and industrial programs are developing equipment, manipulators, and interpretive methods for acoustic emission and ultrasonic holography monitoring and inspection. These programs are expected to culminate in remote inspection methods for reactor welds which should be adaptable to MSBR conditions and needs. The equipment and techniques for remote repair do not exist; however, much of that development as well as the inspection development is interchangeable with remote welding development.

11.4 TASK GROUP 10.1 CONSIDERATIONS OF REMOTE MAINTENANCE DURING PRELIMINARY AND CONCEPTUAL DESIGN

It is highly important that remote maintenance be given adequate consideration during the preliminary and conceptual design stages for molten-salt reactors in order that (1) the required maintenance technology can be identified, (2) provisions for remote maintenance requirements can be properly incorporated in the design of reactors and components, and (3) improved estimates of the cost of remote maintenance can be developed.

11.4.1 Objective

The objectives of work in this task group are to develop a maintenance approach that is consistent with the overall design objectives for the MSBR, and to identify the required maintenance technology which will allow reliable remote maintenance of MSBR's at an acceptable cost.

11.4.2 Schedule

The schedule for work in this task group is shown in Table 11.4.2.

11.4.3 Funding

The operating fund requirements for work in this task group are shown in Table 11.4.3.

Table 11.4.2. Schedule for work in Task Group 10.1 -- Consideration of remote maintenance during preliminary and conceptual design

	Fiscal year				
	1977	1978	1979	1980	1981
10.1.1 Remote maintenance for 1000-MW(e) reference design MSBR					
10.1.1.1 General survey of MSBR maintenance needs					
10.1.1.2 Maintenance requirements for individual components					
10.1.1.3 Determination of required maintenance functions					
10.1.1.4 Determination of design restrictions resulting from maintenance requirements					
10.1.1.5 Estimation of impacts on performance					
10.1.2 Remote maintenance for demonstration reactor					
10.1.3 Remote maintenance for test reactor					
10.1.3.1 Determination of MSTR maintenance requirements					
10.1.3.2 Determination of required maintenance functions					

Table 11.4.3. Operating fund requirements for Task Group 10.1 - Consideration of remote maintenance during preliminary and conceptual design (costs in 1000 dollars)

		Fiscal year				
		1977	1978	1979	1980	1981
10.1.1	Remote maintenance for 1000-MW(e) reference design MSBR					
10.1.1.1	General survey of MSBR maintenance needs		20			
10.1.1.2	Maintenance requirements for individual components		10	25		
10.1.1.3	Determination of required maintenance functions		10	10		
10.1.1.4	Determination of design restrictions resulting from maintenance requirements			10	10	
10.1.1.5	Estimation of impacts on performance			5	5	
	Subtotal 10.1.1		40	50	15	
10.1.2	Remote maintenance for demonstration reactor		10	10		
10.1.3	Remote maintenance for test reactor					
10.1.3.1	Determination of MSTR maintenance requirements			40	30	
10.1.3.2	Determination of required maintenance functions				5	
	Subtotal 10.1.3			40	35	
Total operating funds for Task Group 10.1			50	100	50	

11.4.4 Task 10.1.1 Remote maintenance for 1000-MW(e) reference design MSBR

Although many aspects of remote maintenance development for a 1000-MW(e) MSBR must be carried out during the final stages of design for a particular reactor, a number of important factors must be considered during the preliminary and conceptual design stages in order that a consistent approach can be adopted for demonstration and test reactors, and in order that the required maintenance technology can be identified and developed in a timely manner. Work in this task will consist of a general survey of MSBR maintenance needs during the preliminary conceptual design stage, identification of maintenance requirements for individual components as the conceptual design for the reference MSBR is defined sufficiently, determination of the required remote and semiremote maintenance functions, definition of restrictions on the reference design which result from maintenance requirements, and evaluation of the impacts of maintenance on the economic and nuclear performance of the reference design MSBR.

11.4.4.1 Subtask 10.1.1.1 General survey of MSBR maintenance needs

Work in this subtask will consist of a review of previous work on remote maintenance for MSBRs and an extension of previous work as necessary to provide a general description of maintenance requirements for MSBRs. Many aspects of current MSBR reference design are sufficiently complete for work in this subtask, and the remaining aspects will have been defined by the end of FY 1978 (see Section 8). The maximum temperatures and radiation intensities under which the various maintenance operations would be carried out will be identified. The work will also determine which components are to be replaced and which will be repaired in place. The extent of primary-circuit cell cooldown necessary for the various maintenance operations will be defined, and an overall maintenance philosophy will be developed. The work will also determine where interconnects and maintenance-related pipe cuts and welds will be made.

11.4.4.2 Subtask 10.1.1.2 Maintenance requirements for individual components

Work in this subtask will determine the probable maintenance requirements for individual components for the reference design MSBR. Remote maintenance techniques will be developed for each component including methods for in-service inspection, breaking of component disconnects and optimum location of pipe cuts, methods for component support and transport during maintenance, techniques for component inspection in order to determine whether repair or disposal of a component will be effected, methods for precise positioning of each replacement component, techniques for making up disconnects, and methods for remote pipe welding and weld inspection.

11.4.4.3 Subtask 10.1.1.3 Determination of required maintenance functions

Based on work described in Subtasks 10.1.1.1 and 10.1.1.2, a determination will be made of the probable maintenance functions which will be required for remotely maintaining an MSBR, and of the likely conditions, including temperature and radiation level, under which these functions must be carried out. The aim of this subtask will be to categorize maintenance functions in a manner which shows clearly not only the type of function but the range of variables which must be considered such as pipe diameter, wall thickness, allowable work space, degree of visibility, etc.

11.4.4.4 Subtask 10.1.1.4 Determination of design restrictions resulting from maintenance requirements

Work in this subtask will determine the design restrictions which are necessary for the reference design MSBR as a result of maintenance requirements and will identify any locations where maintenance considerations dictate modification of the reference design.

11.4.4.5 Subtask 10.1.1.5 Estimation of impacts of maintenance on economic and nuclear performance of 1000-MW(e) MSBR

Work in this subtask will be aimed at obtaining an improved estimate of the impacts of remote maintenance on the economic and nuclear performance of the reference design 1000-MW(e) MSBR. If maintenance operations are identified which result in unacceptable nuclear or economic impacts, alternate maintenance approaches and design changes will be evaluated.

11.4.5 Task 10.1.2 Remote maintenance for demonstration reactor

As discussed in Section 8 (Subtask 7.1.1.7), after the reference design for the 1000-MW(e) MSBR has been sufficiently well defined, a preliminary conceptual design will be prepared for a demonstration reactor which will ultimately provide the experience necessary for design of commercial reactors. Work will be carried out in this task during development of the preliminary conceptual design for the demonstration reactor to ensure that the additional maintenance technology, if any, required for the demonstration reactor is identified, and to ensure that the maintenance approach for the demonstration reactor will resemble as closely as is practical that for the reference design MSBR. The general approach to be followed in this task will be similar to that outlined in Subtasks 10.1.2.1 through 10.1.2.4. However, since the conceptual design for the demonstration reactor will not be investigated as fully as the 1000-MW(e) MSBR reference design, there will be a corresponding reduction in the extent to which remote maintenance considerations are developed for the demonstration reactor.

11.4.6 Task 10.1.3 Remote maintenance for test reactor

As discussed in Section 8 (Tasks 7.1.3 and 7.1.4), after the conceptual designs for the 1000-MW(e) reference design MSBR and a demonstration reactor have been defined sufficiently, a conceptual design will be developed for a test reactor which would provide the technology required for design of the demonstration reactor. Work in this task will consist of determining the maintenance requirements for the test reactor and for the individual components that will constitute the test reactor, determination of the required remote and semiremote maintenance functions, and definition of restrictions on the test reactor design which result from maintenance requirements. An important function of this task will be the identification of any critical maintenance technology required for design of the demonstration reactor which will not be provided by the test reactor.

11.4.6.1 Subtask 10.1.3.1 Determination of MSTR maintenance requirements

Work in this subtask will be aimed at determining the maintenance requirements for the test reactor, retaining to the extent practical the maintenance approach and techniques required for the demonstration reactor and the 1000-MW(e) reference design MSBR. The maximum temperatures and radiation intensities under which the maintenance operations will be carried out will be identified. The work will define the probable maintenance requirements for the individual components of the test reactor. Remote maintenance techniques will be developed for each component including methods for in-service inspection, breaking of component disconnects and optimum location of pipe cuts, methods for component support and transport during maintenance, methods for precise positioning of each replacement component, techniques for making up disconnects, and methods for remote pipe welding and weld inspection.

11.4.6.2 Subtask 10.1.3.2 Determination of required maintenance functions

The work discussed in Subtask 10.1.3.1 will serve as the basis for defining the probable maintenance functions for the test reactor, and the conditions under which the maintenance operations will be carried out. The maintenance functions will be categorized in order to show clearly the types of maintenance functions required, and the range of maintenance parameters which must be covered. The resulting requirements will be compared with those established for the demonstration reactor and the 1000-MW(e) reference design MSBR in order to identify those requirements, if any, which fall outside the previously established requirements. A composite list of maintenance functions including the required ranges of maintenance-related parameters will be developed which will serve as the basis for development of MSR maintenance technology.

11.5 TASK GROUP 10.2 DEVELOPMENT OF REMOTE MAINTENANCE TECHNOLOGY

In molten-salt reactor systems, maintenance of components of the primary circuit will be effected by using remotely operated tools and equipment. System components, such as pumps, heat exchangers, and valves will be replaced by remotely breaking disconnects and cutting pipe connections, replacing the component, remaking disconnects and making remote pipe welds, and inspecting the welds by remote techniques.

Remote maintenance requires suitable equipment for viewing and inspection of equipment and systems at temperatures in the range of 500 to 1000°F in the presence of radiation levels of about 10^5 R/hr. Local cooling can probably be employed to lower the temperature to 200 to 400°F. The main steps in remote replacement of components will be cutting pipe connections and breaking disconnects, spreading the pipe ends to provide clearance for component removal, and transporting the component from the cell. Installation of a new or repaired component will involve the steps of maintaining cleanliness control, transporting the replacement component to its in-cell location, aligning the component and pipe ends for welding, tack welding the pipe ends to maintain alignment during final closure welding, and remotely inspecting the weld to ensure that quality and reliability standards have been met.

Many maintenance operations will be undertaken as a consequence of incipient failure detection during operation or in-service inspection, and the detection of incipient failures is a part of this task group. In some situations, in situ repair may be preferred over component removal and replacement.

11.5.1 Objective

The objective of work in this task group is the development of technology required for remote maintenance of molten-salt reactors as identified by work in Subtask 10.1.3.2, and by subsequent experience on the design, fabrication, and operation of components and systems for molten-salt reactors.

11.5.2 Schedule

The schedule for work in this task group is shown in Table 11.5.2.

11.5.3 Funding

Operating fund requirements for this task group are shown in Table 11.5.3.1, and capital equipment fund requirements are shown in Table 11.5.3.2. Capital equipment funds in the amount of \$200,000 will be required in FY 1978 for the design and construction of a Maintenance Development Facility.

Table 11.5.2. Schedule for work in Task Group 10.2 - Development of equipment for remote maintenance

	Fiscal year								
	1978	1979	1980	1981	1982	1983	1984	1985	1986
10.2.1 Development of improved viewing devices									
10.2.2 Development of remote pipe cutting equipment									
10.2.3 Development of seal weld cutting and welding equipment									
10.2.4 Development of preweld cleaning techniques									
10.2.5 Development of pipe spreading and alignment technology									
10.2.6 Development of remote pipe welding techniques									

Table 11.5.3.1. Operating fund requirements for Task Group 10.2 - Development of equipment for remote maintenance (costs in 1000 dollars)

	Fiscal year								
	1978	1979	1980	1981	1982	1983	1984	1985	1986
10.2.1 Development of improved viewing devices			30						
10.2.2 Development of remote pipe cutting equipment		25	60	140	100	60	60	50	
10.2.3 Development of seal weld cutting and welding		20	60	100	60	60	60	50	
10.2.4 Development of preweld cleaning techniques			30	60	67	58	50	45	
10.2.5 Development of pipe spreading and alignment technology			60	150	120	120	116	110	
10.2.6 Development of remote pipe welding techniques		35	96	200	150	150	150	130	
Total operating funds for Task Group 10.2		80	336	650	497	448	436	385	

Table 11.5.3.2. Capital equipment fund requirements for Task Group 10.2 - Development of equipment for remote maintenance (costs in 1000 dollars)

	Fiscal year							
	1977	1978	1979	1980	1981	1982	1983	1984
10.2 Maintenance Development Facility		200						
10.2.1 Development of improved viewing devices				15				
10.2.2 Development of remote pipe cutting equipment			15	20	10	10	20	
10.2.3 Development of seal weld cutting and welding equipment			10	20	20	10	10	
10.2.4 Development of preweld cleaning techniques				5	10	5	5	
10.2.5 Development of pipe spreading and alignment technology			10	20	10	15	20	
10.2.6 Development of remote pipe welding techniques			50			50		
Total capital equipment funds for Task Group 10.2		200	85	80	50	90	55	

11.5.4 Facilities

Molten-salt breeder reactors and test reactors that precede them will require development of methods and equipment for remote maintenance of the highly radioactive reactor primary and auxiliary systems. A facility will be required in which the methods and equipment can be tested on mock-ups of reactor systems. No facility presently exists in which such tests could be made.

A Maintenance Development Facility will be constructed which will consist initially of a mock-up of parts of a reactor cell and an auxiliary equipment cell, mock-ups of parts of typical reactor and auxiliary equipment and piping systems, some automatic cutting, welding, and positioning equipment and equipment necessary for handling remote maintenance tools. This facility will be installed in an existing building. Initially, the work in the facility will be concerned with adapting the automatic cutting, welding, and positioning equipment for remote operation and demonstrating those operations on a simulated reactor system. As designs are evolved for reactor equipment, models of the equipment will be installed in the cells, and methods for maintaining the equipment will be tested and improved. It is anticipated that much of the reactor maintenance will have to be done at temperatures of 200 to 300°C and with special ventilation. Part of the facility will be equipped for conducting maintenance tests at elevated temperatures. This activity will require obligation of \$200,000 in capital equipment funds during FY 1978.

Subsequent development work on remote maintenance techniques for a molten-salt test reactor will be carried out in the molten-salt test reactor mockup (see Section 13).

11.5.5 Task 10.2.1 Development of improved viewing devices

Work in this task will be concerned with the development of improved viewing devices for remote maintenance applications. The use of mirrors has been beneficial in many applications, and commercially available periscopes, omniscopes, telescopes, and fiber optics equipment have been used for a variety of needs in nominal-radiation and high-temperature environments associated with reactor repair and hot cell work.

The application of fiber optics devices to observations in areas where access limitations or obstructions prevent the use of conventional viewing equipment is relatively new, and work in this task group will consist of a survey of fiber optics applications and availability in order to identify potential applications of such devices to remote maintenance operations, and to recommend additional work in areas of promise.

Work in this task group will also include a survey of radiation and high-temperature-resistant television equipment, and procurement and testing of equipment which appears suitable in order to evaluate the need for additional development work in this area.

11.5.6 Task 10.2.2 Development of remote pipe cutting equipment

Considerable experience has been developed at ORNL on the development and use of automated, orbital pipe cutting machinery as part of a feasibility study for the MSR maintenance program. Machining heads were shown to be capable of cutting pipe, trimming the ends square, and preparing end bevels on schedule 40 stainless steel pipe in sizes up to 6 in. with little difficulty. Problems arose in cutting Inconel because of its work-hardening tendencies, which are similar to those of Hastelloy N. Additional difficulties are anticipated for pipe sizes larger than 6 in. since the cutting operations are slow, cutter feed rates are minimal, and cutters dull rapidly and require frequent replacement. Observations indicated that the carriage drive is the limiting factor on cutting ability. Improvements are required to provide a stronger and more positive cutter depth control and more stable longitudinal adjustments. A split-bearing sleeve carriage was proposed for development which could be installed remotely and used for in-cell pipe cutting.

Commercially available pipe cutting equipment appears to be adaptable to remote pipe cutting; however, conventional equipment requires considerably greater clearance than equipment developed by ORNL. Currently, work is underway at the Hanford Engineering Development Laboratory for development of equipment for remotely cutting and welding of the open- and closed-loop reactor top closures for removal and reinstallation of experimental assemblies. The equipment, which is applicable to relatively small (6.72-in. mean diam) pipe, is being tested at temperatures as high as 500°F and is designed to withstand exposure to 10^5 R/hr gamma radiation. It is anticipated that work in this task will benefit greatly from this work as well as from advances in commercial pipe cutting equipment.

Work in this task will be directed toward further evaluation and development of improved carriages including the split-sleeve type. Particular attention will be given to the effect of pipe spring back during the cutting operation which may result in damage to the sleeve end bearings. Work will also be carried out for surveying commercially available equipment and adapting equipment having potential.

11.5.7 Task 10.2.3 Development of seal weld cutting and welding equipment

Work in this task will be directed to the development of techniques and equipment for the remote cutting and welding of seal welds. New types of carriages and weld-head propulsion schemes will be developed for seal weld applications.

11.5.8 Task 10.2.4 Development of preweld cleaning techniques

Final preweld pipe-end preparations include kerf and/or chip removal from the open ends of the pipe joint, removal of salt from the pipe wall, and the installation of a suitable purge block plug into the pipe near the open joint. Acceptable environmental, off-gas airlock, and ventilation conditions must be established within the cell. Cutting chips from mechanical sawing, kerf from plasma flame cutting, and salt residue on the pipe walls adjacent to the cut joint must be removed before the installation of purge blocks or the taking of a facsimile in preparation for final pipe welding.

Work in this task will be directed to the development of preweld cleaning techniques and equipment, and to development of methods for the proper introduction of replacement components. Existing tools and equipment will be modified when possible to provide the necessary cleaning action.

11.5.9 Task 10.2.5 Development of pipe spreading and alignment equipment

There is only limited experience with the use of remotely controlled equipment for spreading the ends of pipe after cutting, positioning replacement components in proper alignment, and holding them in position during welding. Most of the available reactor maintenance experience relates to underwater maintenance, whereas MSBR maintenance must be performed under dry conditions. The limited dry maintenance experience results from work with the MSRE mockup and with MSRE maintenance; however, work is currently underway on other reactor concepts which should be applicable in part to MSBR maintenance requirements. Techniques for pipe alignment were partially developed as part of the Westinghouse Pennsylvania Power and Light Company study for the Pennsylvania Advanced Reactor Program (PAR) during the late 1950's.

Work in this task would determine pipe flexibility requirements and define the extent to which pipe sizes, wall thickness, length, and method of attachment influence flexibility. In a tightly coupled system, such as the reference design 1000-MW(e) MSBR, flexibility is limited and it may be necessary to use tailored spool pieces for joining short sections of large diameter pipe. An analysis will be made of all in-cell pipe systems for anticipated pipe deflection shifts and movements when pipes are severed during maintenance operations. The equipment and pipe support devices required for maintaining alignment, the locations of the cut planes, and the space required for insertion of pressure cylinders for moving the pipe ends will be defined. The potential of split-bearing sleeves for realigning pipe for preweld and weld tacking assembly will be evaluated, and devices of this type will be developed if warranted.

11.5.10 Task 10.2.6 Development of remote pipe welding techniques

Work in this task will be directed toward the development of remote pipe welding techniques for MSBR maintenance. There are currently a number of commercially available automatic welding devices, as well as an ORNL-developed automatic welder which will automatically butt-weld pipes from 3 to 6 in. in diameter having wall thicknesses ranging from 3/16 to 1.5 in. The resulting welds have been shown to meet ASME codes and RDT standards for nuclear-quality gas--tungsten-arc welding of pipe. Presently, the commercial machines must be mounted on pipes manually, and operator judgment is necessary for achieving satisfactory operation.

Work in this task will consist of surveying the commercially available automatic welding devices, procuring one or more devices which show the greatest potential for adaptation to remote maintenance welding applications, and carrying out remote welding tests under simulated remote maintenance conditions. Particular attention will be given to modifications necessary for ensuring adequate resistance to temperatures in the range of 300 to 500°F and gamma radiation levels as high as 10^5 R/hr.

11.6 TASK GROUP 10.3 DEVELOPMENT OF EQUIPMENT AND TECHNIQUES FOR POST-WELD INSPECTION

11.6.1 Objective

The objective of work in this task group is the development of equipment and techniques for remote inspection of welds and welding operations during remote maintenance for MSBR's.

11.6.2 Schedule

The schedule for work in this task group is shown in Table 11.6.2.

11.6.3 Funding

Operating fund requirements for this task group are shown in Table 11.6.3.1, and capital equipment fund requirements are shown in Table 11.6.3.2.

11.6.4 Facilities

No additional facilities will be required for work in this task group. Part of the work will be carried out in facilities used for Task Group 10.2.

Table 11.6.2. Schedule for work in Task Group 10.3 – Development of equipment and techniques for post-weld inspection

	Fiscal year							
	1978	1979	1980	1981	1982	1983	1984	1985
10.3.1 Inspection of automatic welder records								
10.3.2 Adaptation of customary weld inspection methods								
10.3.2.1 Liquid penetrant examination								
10.3.2.2 Radiographic examination								
10.3.2.3 Ultrasonic examination								
10.3.3 Development of advanced methods for weld inspection								
10.3.3.1 Eddy current examination								
10.3.3.2 Acoustic emission techniques								

Table 11.6.3.1. Operating fund requirements for Task Group 10.3 — Development of equipment and techniques for post-weld inspection (costs in 1000 dollars)

	Fiscal year								
	1978	1979	1980	1981	1982	1983	1984	1985	1986
10.3.1 Interpretation of automatic welder records			10	15	10				
10.3.2 Adaptation of customary weld inspection methods									
10.3.2.1 Liquid penetrant examination		10	15	21	15	20	10	10	
10.3.2.2 Radiographic examination		5	20	30	20	25	20	20	
10.3.2.3 Ultrasonic examination		5	25	35	25	25	20	20	
Subtotal 10.3.2		20	60	86	60	70	50	50	
10.3.3 Development of advanced methods for weld inspection									
10.3.3.1 Eddy current examination			15	20	15				
10.3.3.2 Acoustic emission techniques			15	20	15				
Subtotal 10.3.3			30	40	30				
Total operating funds for Task Group 10.3		20	100	141	100	70	50	50	

Table 11.6.3.2. Capital equipment fund requirements for Task Group 10.3 – Development of equipment and techniques for post-weld inspection
(costs in 1000 dollars)

	Fiscal year						
	1978	1979	1980	1981	1982	1983	1984
10.3.2.2 Radiographic examination		5			5	5	
10.3.2.3 Ultrasonic examination		15		5	5	5	
10.3.3.1 Eddy current examination			10	5			
10.3.3.2 Acoustic emission techniques			10	5			
Total capital equipment funds for Task Group 10.3		20	20	15	10	10	

11.6.5 Task 10.3.1 Interpretation of automatic welder records

It appears possible to interpret the data that is recorded during the remote automatic welding of pipe in order to determine the likelihood of a flaw in each weld pass. It is known that excessive arc voltage and low current will cause lack of weld penetration; low arc voltage and high current, or low wire feed and high weld current will cause melt-through; and irregular carriage and weld speeds will result in uneven bead depth and contour.

Work in this task will be directed to determining the extent to which data recorded during remote welding can be interpreted and relied upon for determining the likelihood and location of a weld defect. The feasibility of incorporating this type of weld inspection technique in codes covering remote-pipe welding will be determined, and further work will be carried out if warranted.

11.6.6 Task 10.3.2 Adaptation of customary methods of nondestructive examination of welds

Maintenance and repair of MSBR components by remote welding will require techniques for nondestructive examination to ensure the integrity of welds. It is likely that the inspection techniques will have to be suitable for use at temperatures in the range of 500 to 700°F and in the presence of gamma radiation levels as high as 10^5 R/hr. If necessary, it is probable that the temperature at the point of weld inspection could be lowered to 200 to 400°F by local cooling. Work in this task group will be aimed at adapting customary methods of nondestructive examination of welds to use at the conditions outlined above in cases where this is feasible.

11.6.6.1 Subtask 10.3.2.1 Liquid penetrant examination

Liquid penetrants containing visible or fluorescent dyes are used routinely for detecting surface-connected flaws in welds. However, commonly used materials will not be applicable at the high temperatures anticipated for MSBR maintenance. Products currently under development show promise for use at temperatures as high as 600 to 900°F; however, little data is available on the sensitivity of such products to surface connected flaws.

Work in this subtask will be aimed at surveying commercially available penetrant examination materials that have potential for high temperature application, and for determining the sensitivity and suitability of the products for MSBR maintenance applications.

11.6.6.2 Subtask 10.3.2.2 Radiographic examination

Radiography is a primary means for examination and acceptance of welds. The high gamma radiation levels and high temperatures which will be associated with MSBR maintenance appear to rule out the use of conventional radiography because of the sensitivity of x-ray film to gamma radiation. A potential alternative radiography method uses neutrons as the penetrating radiation, and detection methods which are not sensitive to gamma radiation. It is possible that with improved neutron sources (e.g., ^{252}Cf), acceptable techniques can be developed for inspection of remotely welded joints.

Work in this subtask will be directed to evaluating the feasibility of using neutron radiography techniques for remote inspection of welds in MSBR systems, and to preparing a plan for effecting the required development work necessary for use of this technique if this is justified.

11.6.6.3 Subtask 10.3.2.3 Ultrasonic examination

Ultrasonic examination methods have been used increasingly during recent years for weld inspection because of the ability of this technique to detect discontinuities such as cracks and lack of fusion. The mechanical convenience of ultrasonic probes and their minimal sensitivity to high levels of radiation have led to their use in a number of reactor and hot-cell applications. While welds have been examined successfully with a number of materials, difficulty is encountered in the application of ultrasonic techniques to nickel-base alloys and stainless steels because of variable attenuation of sound and the presence of grain boundary reflections. Additional work is also needed on the development of improved methods for coupling ultrasound from the transducer into the weldment.

Work in this subtask will be directed toward determining the feasibility of and potential for using ultrasonic techniques for remote inspection of welds in MSBR systems, and toward developing plans for work required for use of this technique if this appears to be justified.

11.6.7 Task 10.3.3 Development of advanced methods for nondestructive examination of welds

Because of the difficulties foreseen in applying conventional methods for nondestructive remote inspection of welds, work will be carried out in this task for evaluating the potential of advanced examination methods including eddy current examination and acoustic emission techniques.

11.6.7.1 Subtask 10.3.3.1 Eddy current examination

Methods based on electromagnetic induction of eddy currents have been utilized for detecting flaws, measuring materials properties, and determining the space between adjacent components. Application of this technique to the inspection of welds has been quite limited because spurious signals result from variations in coil-to-specimen spacing such as might result from roughness of a weld bead. Recent advances in eddy current theory and modeling as well as instrumentation suggest that eddy current examination may have potential for remote inspection of welds and determination of pipe joint spacing prior to tack welding. The extent to which eddy currents penetrate a metal is limited; however, it is possible that eddy current techniques could be developed sufficiently for consideration as a replacement for liquid penetrant examination techniques.

Work in this subtask will be aimed toward determining the feasibility of eddy current examination techniques for remote maintenance inspection of welds in MSBR systems, and toward defining the development work required for application of eddy current techniques if this appears justified.

11.6.7.2 Subtask 10.3.3.2 Acoustic emission techniques

The previously discussed nondestructive examination techniques are used to determine the as-fabricated condition of a weld after the welding operation has been completed. Each is an active technique in that matter or energy is applied to the weld in order to determine its condition. The acoustic emission technique is a passive method in which detectors are used for monitoring the sonic energy released within the weld as it is completed produced by actions such as crack formation or propagation. Recent data indicate that acoustic emission techniques have promise for detection of flaws during remote welding operations. The transducer materials required for this technique would likely withstand short term exposure to high temperature and gamma radiation, and coupling of the transducers to the weldment would be simpler since the transducer would not be required to traverse the weld area. If acoustic emission signals were observed, supplementary examinations using other weld inspection techniques would be necessary for determining the location of a flaw.

REFERENCES FOR SECTION 11

1. R. Blumberg, *Maintenance Development for Molten-Salt Breeder Reactors*, ORNL-TM-1859 (June 1967).
2. R. Blumberg and E. C. Hise, *MSRE Design and Operations Report, Part X, Maintenance Equipment and Procedures*, ORNL-TM-910 (June 1968).
3. E. C. Hise and I. Spiewak, Repair of the HRE Core, *Nucleonics* 19: 100 - (March 1961).
4. P. N. Haubenreich, R. Blumberg, and M. Richardson, "Maintenance of the Molten-Salt Reactor Experiment," ANS Winter meeting, Washington, D.C., November 1970 (Complete paper available from authors).
5. *MSR Program Semiannu. Progr. Rept. Feb. 28, 1971*, ORNL-4676, pp. 1-16.
6. *Conceptual Design Study of a Single-Fluid Molten-Salt Breeder Reactor*, ORNL-4541 (1971).
7. *1000-MW(e) Molten-Salt Breeder Reactor Conceptual Design Study Final Report - Task I*, Ebasco Services, N.Y. (February 1972), p. 3-9.
8. P. P. Holz, *Feasibility Study of Remote Cutting and Welding for Nuclear Plant Maintenance*, ORNL-TM-2712 (November 1969).
9. P. P. Holz, *The ORNL Automatic Orbital Pipe Welding Systems*, ORNL-4830 (January 1973).
10. R. W. McClung, *Remote Inspection of Welded Joints*, ORNL-TM-3561 (September 1971).

12. INSTRUMENTATION AND CONTROLS DEVELOPMENT

12.1 INTRODUCTION

A significant effort in the development of MSR's will be devoted to the study of methods for controlling the reactor systems during startup, part load, full load, and under upset conditions to allow proper assessment of the operational and safety implications of various control approaches. While it appears that instrumentation and control systems for MSR's are relatively straightforward, a number of features inherent in this reactor type dictate further development of the technology associated with control methods and systems.

12.1.1 Objective

The general objective of this activity is the development of technology necessary for the design of instrumentation and control systems required for the safe and efficient operation of molten-salt reactors. Specifically, the objectives include (1) the development of computer programs required for transient representation of MSR systems operating under various control modes, (2) the analysis of control systems having promise for molten-salt reactors, (3) the characterization of power, pressure, and temperature transients and levels in MSR systems under normal and upset conditions for the more promising control methods, and (4) the identification and development of instrumentation required for control of MSR's.

12.1.2 Scope

The scope of this activity will be restricted initially to demonstrating that satisfactory control methods can be devised for the various operational modes necessary for molten-salt reactors, and the identification and development of instrumentation required for utilization of control methods having the greatest potential. The work will be concentrated primarily on the requirements for a 1000-MW(e) MSBR in order to identify technology areas requiring further development and demonstration before and during operation of molten-salt test and demonstration reactors. Studies will be carried out as necessary for characterizing transients which may occur during normal and accident conditions with the preferred control methods in order that these conditions can be considered properly during the development of components and materials for the various reactor systems.

As the designs progress for molten-salt test and demonstration reactors, more detailed attention will be given to the control requirements for these reactors.

12.1.2.1 Task Group 11.1 Control analyses

The work in this task group will be directed toward developing computer representations of MSR plant operation under a variety of conditions, developing and analyzing various control methods, determining the requirements for meaningful flux measurements in MSR's, characterizing pressure and temperature transients for various operating modes, specifying the requirements of special instrumentation and control devices such as a salt throttling valve for partially by-passing the secondary coolant around the primary heat exchangers, further evaluating the need for fast scram capability in MSR systems, and determining the need for instrumentation in MSBR processing systems. The modeling and analysis of plant transient behavior will be coordinated with similar efforts associated with safety studies (see Section 7) to ensure optimum utilization of analytical and computing capabilities.

12.1.2.2 Task Group 11.2 Instrumentation development

The work in this task group will be directed toward developing high temperature flux sensors capable of operation at 1000°F and higher with the high reliability required for reactor control systems; the development of improved instrumentation allowing direct measurements of pressure, flow, and level in molten-salt systems; and the assessment of the availability of instrumentation for MSR's and the need for additional development and adaption.

12.2 PROGRAM BUDGET AND SCHEDULE

12.2.1 Schedule and key program milestones

The schedule for work on instrumentation and controls development is shown in Table 12.2.1.1. The key program milestones for this activity are listed in Table 12.2.1.2 and occur at the times shown in Table 12.2.1.1.

12.2.2 Budget

The operating fund requirements for this activity are shown in Table 12.2.2. Capital equipment funds will be required during FY 1980 in the amount of \$170,000 for design and construction of the Instrumentation Test Facility.

12.3 REQUIREMENTS, BACKGROUND, AND STATUS OF DEVELOPMENT

The control system requirements of an MSBR are basically the same as those of other power reactors; however, a number of features which are peculiar to this reactor concept affect the instrumentation and control systems.

In the reference MSBR design, the entire primary salt system is located in a primary containment that is maintained at about 1000°F. This arrangement makes it unnecessary to insulate the pipes and vessels and removes from the reactor cell a multitude of electrical cables, thermocouples, disconnects, and containment penetrations that would be required for heaters located directly on the pipes and vessels. Some connectors and signal transmission lines must either be designed to operate properly in such an environment or must be located in penetrations that are cooled reliably.

The high freezing points of the MSBR fuel and coolant salts impose rather stringent control and protection system requirements. Care must be exercised to prevent freezing of the salt in auxiliary lines, as well as in main salt lines and heat exchangers.¹ The filling and startup procedures, although simplified by the oven concept, will be somewhat complex, as will be the procedure for admitting feedwater into the steam-generator system.¹ Reliable instrumentation must be provided for determining the condition of the salt when it is outside the reactor vessel as well as within.

The effects of fuel circulation on the effective delayed neutron fraction must be considered in designing for transient conditions involving primary system flow changes. These effects are well understood, and experience in the design and operation of circulating fuel reactors gives confidence that this feature will not cause any particular problem.

Fission products in the primary circulating loop present the usual problems of handling radioactive fluids. The presence of these highly radioactive loops also has a potential for increasing background signals in nuclear instrumentation. Replacement of instrument sensors and interconnecting signal lines will in some cases require remote maintenance techniques.

The reference MSBR is designed to have a core differential temperature of 250°F. As in other reactors operating with a large ΔT , means must be provided to limit thermal stresses during abnormal operational events.

The MSBR does not require that a large amount of excess reactivity be available. The ability to adjust fuel concentration during operation and the reduction of ^{135}Xe poisoning by gas stripping reduce two of the largest reactivity requirements of other types of plants. Total control reactivity required for operation will probably be on the order of 1% $\delta k/k$. This small amount of excess reactivity greatly reduces the potential for large reactivity excursions, thus easing requirements on safety

Table 12.2.1.1. Schedule and major milestone designations for instrumentation and controls development

	Fiscal year										
	1977	1978	1979	1980	1981	1982	1983	1984	1985	1986	
11.1 Control analyses				∇ ^a	∇ ^b		∇ ^c	∇ ^d	∇ ^e		∇ ^f
11.2 Instrumentation development				∇ ^g	∇ ^h				∇ ⁱ	∇ ^j	∇ ^k

12-4

Table 12.2.2. Operating fund requirements for instrumentation and controls development
(costs in 1000 dollars)

	Fiscal year									
	1977	1978	1979	1980	1981	1982	1983	1984	1985	1986
11.1 Control analyses		48	141	210	280	295	250	250	250	
11.2 Instrumentation development				60	90	250	300	350	350	
Total operating funds		48	141	270	370	545	550	600	600	

Table 12.2.1.2. Key milestones for instrumentation and controls development

Milestone	Description
a	Complete computer representation of primary, secondary, and steam circuits of MSBR. Complete assessment for need of fast scram capability of MSBR.
b	Complete development of interim control methods for MSBR.
c	Complete specifications for salt throttling valves for MSBR control.
d	Complete modification of computer representation of steam system for MSBR to reflect results from steam generator tube test stand.
e	Complete determination of method for reactivity accounting and inventory control in an MSBR. Complete studies on information achievable by flux measurement analyses in an MSBR.
f	Complete assessment of MSBR processing plant instrumentation needs and availability. Complete development and assessment of control methods for MSBR.
g	Complete development plan for improved pressure, flow, and level devices.
h	Complete development plan for high temperature flux sensors.
i	Complete assessment of availability of instrumentation for MSBR processing plant and development plan for providing instrumentation not available.
j	Complete development and testing of prototypic devices for improved pressure, flow, and level measurements.
k	Complete development and testing of prototypic high-temperature flux sensors.

rods. The ability to drain the fuel away from the moderator into a noncritical configuration is a very important feature of the molten salt reactor concept. The intent is not to use the fuel drain for fast shutdown but to assure long-term shutdown margin under unusual circumstances, hence fast-acting drain valves are not required.

12.3.1 Requirements and current concepts

12.3.1.1 Systems for normal operation

Normal operation of an MSBR includes all phases of startup from cold or hot standby conditions, production of electric power at demand loads between 20 and 100% of design capability, and scheduled shutdown. The control systems must allow for the different requirements for the various operating modes and establish and maintain safe and appropriate operating conditions. The systems must coordinate the operation of the reactor, the primary- and secondary-salt loops, the steam generators, and system auxiliaries. In general, load demand is the primary signal to which the control subsystems must respond. However, while matching the power generation with the load, the control system must also maintain system temperatures and their rates of change within acceptable limits. Specific areas of concern are the temperature in the salt loops, and the salt temperatures which must be maintained well above the freezing point throughout the circulating systems (with the possible exception of some areas in the steam generator).

The present concept is to control the nuclear power level by graphite rods which are used in an automatic control loop to maintain reactor temperature at a set point programmed according to the needs of the steam system. This arrangement is a variation of a scheme successfully demonstrated on the MSRE, where the temperature set point was defined by the operator. In such a control system, the reactor power is determined by the load, with a temperature base line independently determined to provide steam at the desired temperature.

Maneuvering from one power level to another requires control of steam temperature during the transient. The current concept involves automatic control of secondary salt flow rate through the steam generator in order to take advantage of the thermal capacity of the salt while the reactor power level is being readjusted to the new requirement.

In a multiloop plant, such as the reference MSBR, the control system must adequately respond to loop interactions. The most satisfactory approach appears to be one in which each loop is controlled as a unit to produce a specified amount of steam under well-defined conditions, with the balancing of the loops being controlled by a master programmer — perhaps a digital computer — that is responsive to the needs of the power grid. This programmer would adjust set points on appropriate closed-loop controllers associated with the coolant loops.

12.3.1.2 Emergency systems

In addition to providing normal control functions, the instrumentation and control system must provide protection against a variety of anomalous or accident conditions. Although the entire control system should contribute to safe and orderly operations, there will be a system dedicated entirely to protection of personnel and to the prevention of major equipment damage. This latter system, the plant protection system (PPS), includes monitoring instrumentation to detect off-normal conditions, logic subsystems to make decisions and initiate corrective actions, actuators to effect system control actions, and post-accident monitoring systems.

The plant protection system must be capable of shutting down the plant when necessary and carrying out other protective functions, such as ensuring that systems are in order for containing the radioactivity in the event of a major accident and the removal of afterheat following an emergency shutdown where normal cooling is impaired.

Whereas the control rods will be graphite partially inserted into the core so that positive and negative reactivity changes can be made, the safety rods will be neutron-absorbing poison rods of considerably more reactivity worth. Because of their effect on neutron economy and breeding, the safety rods would normally be withdrawn out of the active core region. However, continuous adjustment of their position should be possible to facilitate recovery from off-normal conditions.

It is not clear at this time that a fast "scram" capability will be required. The prompt negative temperature coefficient of the fuel plus the significant thermal capacity of the salt and graphite are factors which make the plant less sensitive to reactivity excursions. However, detailed analyses of a particular plant design will be necessary to establish the precise requirements of the PPS.

12.3.1.3 Instrumentation

The operational control systems and the plant protection system will require extensive instrumentation to provide input to the automatic decision-making process of control. Measurements of neutron flux levels, as well as of the nonnuclear variables such as flow rates, pressures, temperatures, etc., will be vital to effective control of the plant. Some instrument sensors and signal transmission lines, and possibly some containment penetrations will be required to operate reliably in hostile environments of high temperature, high radiation levels, or both. The high residual radioactivity in the reactor cell will make direct maintenance impossible in many locations, and accessibility of instrument components for remote disconnect and replacement will be necessary.

In general, conventional electronic or pneumatic signal conditioning equipment can meet the needs of the MSBR. However, the size and complexity of the plant will make it highly desirable to use digital computer techniques for multiplexing, data storage and retrieval, calculation, and other functions. Optimization of the plant output will require development of sophisticated control schemes. A high degree of automation and supervisory control will be necessary in the MSBR, as in any large multiloop plant, because of the large number of interacting processes. Use of automatic control loops for a large number of system control functions is commonplace; however, the integration of these into effective system control is often left to the operator. Significant improvements in operation can be achieved if overall system control is highly automated using well-established techniques.

12.3.2 Experience with the MSRE and other facilities

A large number of out-of-pile and in-pile loops and other facilities have been operated with molten salt at ORNL over the past 20 years which have had instrumentation and control systems of varying degrees of complexity. In addition, ORNL and others have operated high-temperature systems containing molten metals or gases, and a number of reactors of these types have been operated in the U.S. and abroad. Although these have provided experience in instrumentation that is applicable to MSR's, the most direct and useful information has come from the operation of the MSRE.²

Successful operation of hundreds of thermocouples attached to the salt system walls in the MSRE gives confidence that reliable temperature measurements can be made at the elevated temperatures of molten-salt reactor systems. Although there was considerable scatter in the readings of the couples under different heaters when the salt was actually isothermal, techniques of biasing the outputs were used to provide thoroughly acceptable measurements.³ The importance of careful selection and calibration, details of fabrication and installation, and strict quality control was evident, in that only 12 of the 330 thermocouples failed during five years of operation.

Pressure and differential pressure measurements in the coolant salt systems were made using NaK-filled transmitters. No direct measurement of salt pressure was made in the primary system, where gas pressure measurements were used to infer salt-system pressure. Direct measurements are desirable in an MSBR, and additional development may be required for such applications.

The measurement of salt flow rate in the secondary system was made by means of a venturi and a NaK-filled differential pressure transmitter. No direct measurement was made of flow in the primary system. Inasmuch as the reactor was operated with constant primary-salt flow rate, no particular problem existed in normal operation. As part of the plant protection system instrumentation, pump motor current was measured.

Though not a precise indication of flow, this measurement plus pump speed gave adequate assurance of flow. That is, the pump motor current would be less than normal even though the speed was normal if for some reason the salt flow was reduced. Direct measurement of the flow in the primary system would be desirable for a power reactor, especially if variable flow is used.

Level measurements were made with single-point probes as well as bubblers and float level systems. These operated very well over the life of the plant, but each has limitations which may necessitate additional development for application to MSBR service.

Containment penetration cable seals were difficult and costly to install, and their performance was marginal.² In the furnace concept of the MSBR it will be desirable to locate the seals in thermally insulated areas.

In addition to valuable experience in instrumenting molten-salt systems, the MSRE gave an opportunity to verify methods of analysis of the dynamics of circulating-fuel reactors. The operation with ^{233}U was particularly interesting because of the unusually small effective delayed neutron fraction ($\beta_{\text{eff}} = 0.0019$). Analyses and tests made prior to loading ^{233}U into the MSRE gave confidence that the system would be well behaved with regard to stability and controllability.^{4,5} Results of tests performed after loading were in good agreement with the predictions.⁶

The MSRE rod controller was designed to make the reactor operate in a load-following, or reactor-slave-to-load, mode in the power range. In this mode the operator selected the desired temperature of the salt leaving the reactor core, and the steady-state reactor power was determined by the rate at which heat was rejected by the air-cooled heat exchanger in the secondary salt system. From an experimental viewpoint this allowed easy automatic control of temperature and power level, with practically no interaction between them. For a power reactor this scheme has the potential for controlling steam temperature independently of power level. The control system used on the MSRE met the specific requirements of that reactor and encourages the use of such a controller as part of the overall MSBR plant control system.

The digital data collecting and computing system for the MSRE was used extensively with excellent results. The overall availability after an initial debugging period was over 95%.⁷ The system proved invaluable for the timely and economic collecting, logging, and analyzing of experimental data generated by the MSRE. In addition, it was used to provide operator guidance through the standard printout of signals in the form of routine periodic logs, alarm signal printout, routine calculations such as heat balance and reactivity balance, and operator-demanded functions and calculations. It was used extensively for the control and instrumentation of reactor dynamic tests, such as frequency response and temperature response experiments,⁸ for retrieving and processing data previously stored on magnetic tapes for analysis, and to provide information relative to the time, cause, and effect of abnormal operating

events. Programs were developed to aid in calibration of analog systems and in diagnosis of troubles. A program was developed for a fast Fourier transform which was programmed to run on line in background time and which was used routinely for on-line analysis of neutron fluctuation data. By use of this program it was possible to monitor the bubble fraction in the fuel salt.^{9,10}

The overall experience with the computer system was excellent and demonstrated the tremendous value of such a system in a complex plant. A comprehensive data collecting and computing system for an MSBR is considered to be indispensable.

The MSRE experience is valuable in demonstrating that most of the unique instrumentation and control problems associated with circulating fuel reactors are amenable to solution with familiar techniques. Those problems which were not solved or which were circumvented due to limited time or funds will be easier to resolve for MSBR applications by the insight gained from MSRE operation.

12.3.3 Status of control analyses

Preliminary studies of startup, standby, and shutdown procedures have been carried out for the reference design MSBR, although only to the point of determining feasibility. In making these analyses, several basic restraints on operation of the plant were recognized. The freezing temperatures of the primary and secondary salts are such that the salt systems must be filled and salt circulated isothermally at 1000°F before power withdrawal can be initiated by decreasing the coolant-salt temperature. To avoid freezing of the salt and to prevent excessive temperature gradients, the minimum feedwater or steam temperature to the steam generators for the reference design system must vary between 1000°F at zero load and 700°F in the 8 to 100% power range. In addition, the afterheat load in the reactor system, which decays slowly, may require that the feed water and heat rejection systems remain in operation following shutdown of the main steam system.

Most of the special systems and equipment needed to handle the startup and shutdown conditions in an MSBR station are associated with the steam-power system.¹¹ The requirements impose some departure from the equivalent systems used in conventional fossil-fired supercritical-pressure steam plants and will require further study. Different steam generator designs, for example reentrant or concentric-tube types, would not require heating the feedwater as hot as 700°F, and would alter the steam plant arrangement. An auxiliary boiler is necessary for startup from the cold condition.

12.3.3.1 Computer models

The dynamics and control studies of MSBR plants have been concentrated about the normal operating power range, and a series of studies has been made to examine these operating characteristics.^{12,13} The studies have been implemented with analog and hybrid computer simulations of the plant characteristics.^{14,15} All of the simulations have been patterned after the MSBR reference design,¹ but the nature of the models is such that they would have general applicability. For the purpose of these analyses the MSBR plant consisted of a simplified graphite-moderated, circulating-fuel reactor, a shell-and-tube heat exchanger for transferring the generated heat to a secondary coolant salt, a shell-and-tube supercritical steam generator, and several possible control systems.

Due to the very nonlinear nature of the once-through steam generator, it was necessary to develop a highly detailed model of this part of the system. In order to approximate overall plant performance, the earlier models used lumped-parameter, log-mean-differential-temperature analog simulation of the steam generator, although the accuracy was known to be severely limited. At the same time, a hybrid digital-analog model was developed and used initially to examine the stability of the steam generator.¹⁶ The hybrid model of the steam generator was combined with an analog representation of the other plant components, resulting in an overall simulation in which considerable confidence could be placed. Representative transient responses using this model are described in Reference 15.

The general validity of the all-analog models was confirmed, although, as expected, some disagreement in absolute values was observed. The trends indicated in the analog studies are correct, but the magnitude and rates of change of variables during transients should be used only as general guides.

The hybrid model was used to study control schemes and normal plant maneuvering. Some more severe transients were examined to determine system response to abnormal situations. The severity of the transients that could be run on the hybrid simulation model was, however, limited by the steam generator model, which used 0.5-second calculational time steps. Consequently, it will be necessary to improve the accuracy with which the steam generator can be represented (probably using a digital computer) in order to study more severe transients and complement the plant safety analysis.

12.3.3.2 Analysis of steady-state conditions

The first step in the formulation of a control system to enable the plant to undergo changes in load was to determine the steady part-load temperature and flow profiles for operation between 20 and 100% of full load. For initial considerations it was desirable to fix or predetermine the steady-state values of some variables for part-load operation. Turbine

limitations require that the turbine throttle temperature be held nearly constant (1000°F for the cases studied), and the feedwater temperature was held constant as well (700°F). The primary salt flow rate was assumed constant at design point for steady-state considerations. With these limitations imposed, it was found that the secondary-salt temperature at the steam generator outlet could not be held above the salt freezing point at part loads below about 50%. Thus methods must be developed which allow more effective decoupling of load effects on salt temperatures. Some possibilities are: (1) allowing the steam temperature to increase above the 1000°F design point as the load decreases, with subsequent attemperation of the steam with injected feedwater; (2) increasing the feedwater temperature above the 700°F design point as the load decreases; (3) reducing the number of steam generators in use as load decreases; and (4) using a salt throttling valve to bypass some of the secondary-salt flow around the primary heat exchanger to reduce the temperature of the salt entering the steam generator. Steam attemperation and secondary salt bypass were the subject of additional steady-state analysis of the plant concept. Either scheme or a combination of the two appears to permit the establishment of acceptable part-load operating conditions.

12.3.3.3 Analysis of transient behavior

The models described have been used for transient analysis of the plant and proposed control schemes. The power operating range for a typical plant is expected to range from approximately 20% to 100% of full design load. Throughout this load range the steam temperature to the turbine throttle must be held essentially constant, the primary- and secondary-salt temperatures and flow rates must be kept within acceptable limits, and the resulting stresses due to induced thermal gradients must remain within acceptable ranges.

A master load programmer may be needed to divide the required load demand among the multiple coolant loops and steam generators. It should be possible to operate the plant at partial loads by operating some loops at 100% capacity while other loops deliver no power. The control studies have shown that stable plant load control may be accomplished using two basic control loops: a steam temperature controller and a reactor outlet temperature controller. To achieve close control of steam temperature during load transients it is necessary to vary the secondary-salt flow rate in the steam generator. An additional control subsystem may be necessary if a salt bypass valve is used in order to maintain the desired coolant salt temperatures. The reactor outlet temperature controller examined was similar to that used successfully on the MSRE.¹⁷

A load demand signal determines the reactor outlet temperature set point. The measured reactor inlet temperature is subtracted from the reactor outlet temperature set point, and since the primary-salt flow rate is constant, a reactor power set point is generated by multiplying this ΔT by a proportionality constant. The measured value of reactor power (from neutron flux) is compared with the reactor power set point, and any error

is fed to the control rod servo for appropriate reactivity adjustment. The reactor power set point, generated from the outlet temperature, is a function of the reactor inlet temperature during a transient and thus a function of dynamic load.

There are certainly other possible control schemes for achieving satisfactory plant performance. Analog simulations have shown that an integrated control scheme is essential to good performance. If excessive thermal stresses are produced by the transients that accompany load changes, they can be reduced by varying the primary salt flow rate as a function of load.

The small isothermal temperature coefficient of reactivity implies that only modest amounts of control reactivity are needed to accomplish plant load maneuvering. For the reference design, a typical maneuver from 50% to 100% power at a rate of 5%/min required 0.05% $\delta k/k$ and a rate of 0.0001%/sec $\delta k/k$. The maximum system temperature rate of change for this transient was about 0.3°F/sec at the reactor outlet.

12.3.3.4 Accident analyses

The most likely abnormal power excursions would result from sudden changes in load demand or rapid changes in salt flow rate in either the primary or secondary system, as a result of pump or power failure. A few limited cases of this type have been examined on the hybrid simulation. Some less-likely reactivity anomalies were also briefly examined on the hybrid model. Conceivable reactivity changes may result from primary flow variation, fuel addition accidents, core geometry changes, or failure of one or more control rods.

A reactor shutdown or protection system must be coordinated with the salt circulation loops and the steam plant. If the load is suddenly lost, the reactor power generation must be reduced to avoid overheating. Similarly, if the reactor is shut down the steam load must be quickly reduced to avoid subcooling or freezing of the salt. Similar situations arise due to salt circulation pump failure. For example, if primary flow is lost, followed by an appropriate reduction in load demand and reactor power, the primary salt could still freeze in the heat exchangers because of the increased residence time unless secondary flow is also reduced.

The plant emergency procedures clearly will be somewhat complex because of the high salt freezing temperatures, and a careful analysis will be needed to derive satisfactory solutions.

12.3.3.5 Reactivity control

Long-term reactivity adjustments are expected to be accomplished by varying the fuel concentration. Normal regulating and shimming functions for load following and shutdown are within the calculated capabilities

of a system containing a few graphite rods, as proposed for the reference design.¹⁸

Some events may be anticipated that would require additional negative reactivity or reactivity rates beyond the capability of the graphite rods alone. Poison rods could be used to provide this additional reactivity control and to provide substantial shutdown margin. However, having poison rods in the core during normal operation is undesirable because of their adverse effect on breeding. The poison rods will probably be held outside of the core poised for rapid shutdown if needed. They may also be used for additional shimmiing during core loading or for other operations or abnormalities but the exposure at power will be short and the effect on breeding and rod life will be small. We do not presently anticipate that extremely fast insertion, or "scram" of the rods will be necessary, although reliable insertion must be assured.

12.3.4 Status of instrumentation development

12.3.4.1 High-temperature flux sensors

In the reference MSBR, the entire reactor cell will operate at about 1000°F. Thus any nuclear detectors which are located in this space must be capable of operating at such high temperature or else they must be cooled. If in-core detectors are required the service conditions will be even more severe. No detectors are presently available for operation above 900°F, and even for the higher temperatures only special developmental models exist. Similar problems exist in the liquid metal fast breeder reactor program, and development work is being done. It may be possible to locate ionization chambers in specially cooled wells or thimbles located outside the reactor vessel. For use in the reactor protection systems, such chamber wells would have to be designed with the same performance reliability as required of the protection system, since failure of the cooling systems would bring about failure of the detectors.

Neutron fluctuation analysis proved to be a valuable tool for monitoring anomalous behavior in the MSRE.^{9,10} Unfortunately, one of the requirements for obtaining good results with this technique is a high detection efficiency for core-coupled neutrons. While no detailed calculations have been made of neutron fluxes outside the reflector and vessel, it is possible that in the MSBR these fluxes will be too low to provide the desired signal-to-noise ratio for some types of fluctuation analysis.

All of the proposed nuclear detector locations are within the high-temperature primary containment oven and have in common the problem of containment penetration seals. Generally, the specifications for penetrations for nuclear detectors are more demanding than those for process sensors because of the typically very small signal currents delivered. The location and detailed requirements of these penetrations have not yet been determined, but the need for some development work in this area

is anticipated. The signal transmitting lines will require special design and some development because of the high-temperature environment.

12.3.4.2 Plant instrumentation

Although MSBR system instrumentation can reasonably be expected to require some designs beyond the present state of the art, no problems are foreseen that could not be resolved by further development of components and techniques.^{2,19} Many instrument components used successfully in the MSRE and others being developed for the LMFBR will be directly applicable to the MSBR. Similarly, experience being gained by the utilities industry with instrumentation of supercritical pressure steam systems will be applicable to the MSBR.

MSBR process instrumentation located outside the biologically shielded areas and not an integral part of the containment system can be conventional equipment. Some standard components, however, may require upgrading, and a strict quality control program will be required to ensure a level of reliability and performance commensurate with MSBR requirements.

All process instrumentation components located within the containment cells or as an integral part of the containment system probably should be considered developmental. These components are predominantly primary sensing elements for measurement of flow rates, pressures, levels, weights, and temperatures in the salt-containing pipes and vessels, in the associated purge and off-gas systems, and in the salt chemical processing facilities. Other such components are final control elements (such as off-gas control valves), lead-wire and piping connections to the sensing and final control elements, remotely operated disconnects, and containment penetration seals.

The electrical conductivity of the MSBR salts will be a factor in selecting the type of primary sensing elements than can be used. The conductivities of MSBR salts are estimated to be about 1 mho/cm — about the same as MSRE salts. This means, for example, that magnetic flowmeters probably cannot be used, and most of the devices will be similar to those used on the MSRE.

Some development will be required to adapt MSRE control components to the higher pressures and temperatures that will exist in portions of the MSBR. Development of other equipment and techniques, such as electrical penetrations into salt-containing pipes and vessels, would undoubtedly lead to improved instrumentation.

12.3.4.3 Salt throttling valves

One of the more promising plant control schemes depends upon throttling in a secondary salt bypass around the primary heat exchanger. (Tight shut-off is not required of the valve in this bypass.) The maximum and

minimum flow rates and the rate of change of flow rate necessary to achieve satisfactory plant control will need to be factored into the development of a valve for this service.

12.3.4.4 Digital computer application for control and data handling

The reference design includes the reactor, four primary loops, four secondary loops, each having four reheaters and four steam generators, and a multi-stage turbine. All of the loops interact or require responsive action from other loops when perturbed, and the correct action to take may not be simply perceived. Computer control and surveillance of the plant is desirable to relieve the operators of difficult tasks and can be expected to improve the safety and reliability of operation. Design planning should include from the beginning provisions for optimum utilization of computer techniques.

12.3.4.5 Chemical plant instrumentation and control

The instrumentation requirements of a full-scale chemical processing plant have received only minimal attention from instrument designers. The processes involved have been instrumented and controlled on laboratory or pilot plant scales, but not with the volumes and radiation levels expected in the full-scale plant. Early evaluation of potential problems is needed to enable initiation of required development on a timely basis.

12.4 TASK GROUP 11.1 CONTROL ANALYSES

The work in this task group is concerned with the analysis and development of control systems required for MSBR operation under startup, standby, part load, full load, shutdown, and accident conditions in a 1000-MW(e) MSBR; and the characterization of MSBR operation with control systems showing the greatest potential.

12.4.1 Objective

The objective of this task group is to develop the necessary technology required for design of control systems for a 1000-MW(e) MSBR, and to identify the operating characteristics of the reactor system in sufficient detail to guide Program activities in areas including the development and testing of materials, development of high temperature design methods and data, safety analyses, and component development.

12.4.2 Schedule

The schedule for work in this task group is given in Table 12.4.2.

Table 12.4.2. Schedule for Task Group 11.1 -- Control analyses

	Fiscal year									
	1977	1978	1979	1980	1981	1982	1983	1984	1985	1986
11.1.1 Computer representation of plant operation	0									
11.1.2 Development of control methods										
11.1.3 Flux measurement analyses										
11.1.4 Pressure and temperature transients										
11.1.5 Salt throttling valves										
11.1.6 Reactivity accounting and inventory control										
11.1.7 Fast scram capability										
11.1.8 Processing plant instrumentation										

12.4.3 Funding

The operating funds required by this task group are summarized in Table 12.4.3.

12.4.4 Task 11.1.1 Computer representation of plant operation

The work in this task will be directed toward the development of improved computer representations of the MSBR primary, secondary, and steam systems and the control systems which influence their operation. Analog and hybrid computer simulations along with digital computer representations will be extended or developed as necessary to allow dynamic and control studies required for characterizing the operation of an MSBR under a variety of operating conditions. It is believed that analog modeling can be used to advantage when determining general system behavior, however, digital representations will be required for the more complex and detailed calculations necessary for final evaluation and study of reactor plant operations. The computer representations thus developed will be sufficiently general to allow study of alternate control methods and systems, and will be sufficiently detailed that meaningful characterizations of reactor plant operation can be obtained for the purposes of specification of operating transients for component design studies, determination of materials requirements and probable service conditions, and some accident analysis work.

12.4.5 Task 11.1.2 Development of control methods

Studies will be carried out using the computer representations of MSBR systems developed in Task 11.1.1 to identify and investigate various control methods which adequately decouple load effects and temperature levels. Both steady state and transient conditions will be examined. The studies will be carried out initially in sufficient detail to demonstrate the feasibility of one or more control methods, and systems showing the greatest potential will be investigated in greater detail. Control methods which will be considered include: (1) allowing the steam temperature to increase above the 1000°F design point as the load decreases, with subsequent attemperation of the steam with injected feed water; (2) increasing the feed water temperature above its 700°F design point as the load decreases; (3) reducing the number of steam generators in operation as the load decreases; and (4) by-passing some of the secondary salt around the primary heat exchanger to reduce the temperature of the secondary salt entering the steam generators.

12.4.6 Task 11.1.3 Flux measurement analyses

The work in this task will be directed toward determining the accuracy with which core-coupled flux measurements can be made in an MSBR and to defining the extent and type of information which can be obtained through analysis of neutron fluctuation data. Particular attention will be given

Table 12.4.3. Operating fund requirements for Task Group 11.1 -- Control analyses
(costs in 1000 dollars)

	Fiscal year									
	1977	1978	1979	1980	1981	1982	1983	1984	1985	1986
11.1.1 Computer representation of plant operation		48	51	60	60	60	40	40	40	
11.1.2 Development of control methods			30	60	60	40	40	40	40	
11.1.3 Flux measurement analyses					30	30	30	30	30	
11.1.4 Pressure and temperature transients			30	50	50	50	50	50	50	
11.1.5 Salt throttling valves			10	10	10	5				
11.1.6 Reactivity accounting and inventory control					30	30	30	30	30	
11.1.7 Fast scram capability			20	30						
11.1.8 Processing plant instrumentation					40	60	60	60	60	
Total operating funds for Task Group 11.1		48	141	210	280	295	250	250	250	

to use of this approach for obtaining long-term reactivity measurements. Sufficient work will be carried out to determine whether out-of-core measurements will suffice, and to determine the characteristics of an acceptable measurement system.

12.4.7 Task 11.1.4 Calculation of pressure and temperature transients

The work in this task will be directed toward calculating the pressure and temperature transients at a number of critical locations in the vessels and piping during a full load, part load, changing load, and accident conditions for the more promising control methods in order to help guide the development of technology related to materials development and evaluation, development of high temperature design methods and data, component design and testing, and safety analyses.

12.4.8 Task 11.1.5 Determination of requirements for salt throttling valves

The work in this task will be directed toward characterizing the requirements for salt throttling valves which are employed in one of the more promising plant control schemes. The maximum and minimum flow rates and the rate of change of flow rate necessary to achieve plant control will be determined, and other characteristics of the valves determined as necessary.

12.4.9 Task 11.1.6 Development of methods for inventory accounting and control

The work in this task will be directed toward developing methods for maintaining a long-term reactivity balance in an MSBR system. The established technique of accounting for all significant reactivity additions and withdrawals from the reactor system, including the calculation of buildup and burnout of poisons, will be complicated in an MSBR because many factors that can affect reactivity may not be determinable in a system utilizing continuous fuel processing. Methods based on subcriticality measurements will be considered. The accuracy with which a long term reactivity balance can be established will be defined in order to provide Program guidance in the areas of technology development related to control systems and equipment and to safety analyses.

12.4.10 Task 11.1.7 Evaluation of need for fast scram capability

The work in this task will be directed to evaluating the need for fast scram capability in MSBR systems, and to defining the consequences of fast scram in terms of system transients and the effects on control systems, components, and system temperatures and pressures.

12.4.11 Task 11.1.8 Determination of processing plant instrumentation needs

The work in this task will be directed to determining the instrumentation required for safe and efficient operation of the fuel processing system.

This task interfaces closely with Task 2.1.6 (Processing System Control) in which the primary control variables for the processing system will be identified and their relation to the desired control action specified. The work in this task will be concerned with developing the control systems necessary for maintaining important process variables within desired limits.

12.5 TASK GROUP 11.2 INSTRUMENTATION DEVELOPMENT

12.5.1 Objective

The objective of this task group is to develop the technology required for design and specification of instrumentation for a 1000-MW(e) MSBR.

12.5.2 Schedule

The schedule for this task group is shown in Table 12.5.2.

12.5.3 Funding

The operating funds required by this task group are shown in Table 12.5.3. Capital equipment funds in the amount of \$170,000 will be required during FY 1980 for design and construction of the Instrumentation Test Facility.

12.5.4 Facilities

Molten-salt breeder reactors will need instrumentation for sensing flows, temperatures, pressures, liquid levels, and other parameters in molten salts at temperatures as high as 750°C. Such instrumentation, satisfactory for use in an MSBR, does not presently exist. Much of the testing of instrumentation that is developed will be done in facilities provided for testing of major components. A separate small facility is needed for making preliminary tests on models or prototypes of new sensors as they are developed. No facility presently exists in which such tests could be made.

An instrument test facility will be constructed which will consist of a small salt circulation loop, a set of tanks containing salt for static tests, essential auxiliaries, test stands on which the equipment will be mounted, housings, and a ventilation system. The facility will include the instrumentation and controls necessary for operation of the equipment.

Table 12.5.2. Schedule for Task Group 11.2 - Instrumentation development

	Fiscal year							
	1979	1980	1981	1982	1983	1984	1985	1986
11.2.1 High temperature flux sensors								
11.2.2 Improved pressure, flow, and level devices								
11.2.2.1 Direct pressure transmitters								
11.2.2.2 Direct flow measurements								
11.2.2.3 Improved level devices								
11.2.3 Assessment of instrumentation availability								

Table 12.5.3. Operating fund requirements for Task Group 11.2 — Instrumentation development
(costs in 1000 dollars)

	Fiscal year							
	1979	1980	1981	1982	1983	1984	1985	1986
11.2.1 High temperature flux sensors			30	70	100	100	100	
11.2.2 Improved pressure, flow, and level devices								
11.2.2.1 Direct pressure transmitters		20	20	50	50	60	60	
11.2.2.2 Direct flow measurements		20	20	50	50	60	60	
11.2.2.3 Improved level devices		20	20	50	50	80	80	
Subtotal for 11.2.2.2		60	60	150	150	200	200	
11.2.3 Assessment of instrumentation availability				30	50	50	50	
Total operating funds for Task Group 11.2		60	90	250	300	350	350	

Cover gas will be obtained from a system used by several facilities. Off-gas will be discharged to a common off-gas system. The facility will provide for simple static and dynamic tests of models and prototypes of reactor instruments as they are developed. Simple thermal transient and thermal cycling tests can be made prior to more elaborate and extensive tests in other facilities. Electrical heating and air cooling will be provided so that testing can be done at temperatures from the liquidus temperature of the salt in use (as low as 350°C) to 750°C. This activity will require obligation of \$170,000 in FY 1980.

12.5.5 Task 11.2.1 Development of high temperature flux sensors

The work in this task will be directed to the development of devices for measurement of neutron flux level at temperatures of 1000°F, or higher if necessary, which will meet the high standards of reliability required for use in MSBR control and protection systems. Attention will also be given to the requirement that the flux sensors and associated signal transmitting lines must operate in a high-temperature, high-radiation-level environment. Prototypic flux sensors will be fabricated and tested under representative conditions for MSBR application.

12.5.6 Task 11.2.2 Development of improved pressure, flow, and level devices

The work in this task will be directed to the development of improved devices which will allow direct measurement of pressure, flow, and level in the primary and secondary salt circuits of an MSBR.

12.5.6.1 Subtask 11.2.2.1 Direct differential and absolute pressure transducers

The work in this subtask will be directed to the development of devices and techniques allowing the direct measurement of differential and absolute pressure in MSBR primary and secondary salt circuits, and which are capable of operation at 1000-1300°F. Potential approaches for these transducers will be identified, and the more promising approaches will be considered in detail. Prototypic transducers will be constructed for long-term testing under service conditions anticipated in MSR systems.

12.5.6.2 Subtask 11.2.2.2 Direct primary circuit flow measurements

Several of the more promising methods for MSBR control utilize variable flow of fuel salt through portions of the primary circuit. Utilization of these methods will be dependent upon the availability of highly reliable instrumentation allowing the direct measurement of salt flow rate at one or more points in the reactor primary circuit; such instrumentation does not now exist. The work in this subtask will be directed initially to the identification of potential methods for direct flow measurement

in the primary circuit, and to the selection of those approaches which offer the greatest potential. Development work will be carried out as necessary leading to the fabrication and testing of prototypic devices under service conditions anticipated in MSBR systems.

12.5.6.3 Subtask 11.2.2.3 Improved level devices

The level-measurement devices employed in the MSRE were based largely on the indirect measurement of level via measurement of gas pressure in bubbler devices. While satisfactory for many applications, it is highly desirable that level devices be developed which measure directly the salt level at critical points in an MSBR system. The work in this sub-task will be directed to identifying potential level devices capable of direct measurement, and to the necessary development of the more promising devices. The work will culminate in the fabrication and testing of prototypic level devices which are capable of direct level measurements and of operation at 1000 to 1300°F.

12.5.7 Task 11.2.3 Assessment of instrumentation availability

The work in this task will be directed to assessing the availability of instrumentation required for MSBR operation and to identifying areas where additional development work will be required.

REFERENCES FOR SECTION 12

1. *Conceptual Design Study of a Single-Fluid Molten-Salt Breeder Reactor*, ORNL-4541 (1971), pp. 122-123.
2. R. L. Moore, *Further Discussion of Instrumentation and Controls Development Needed for the Molten Salt Breeder Reactor*, ORNL-TM-3303 (Aug. 5, 1971).
3. *MSR Program Semiann. Progr. Rept. Aug. 31, 1967*, ORNL-4191, pp. 22-24.
4. R. C. Steffy, Jr. and P. J. Wood, "Theoretical Dynamic Analysis of the MSRE with ^{233}U Fuel," ORNL-TM-2571, July 1969.
5. *MSR Program Semiann. Progr. Rept. Feb. 28, 1968*, ORNL 4254, pp. 32-35.
6. R. C. Steffy, Jr., "Experimental Dynamic Analysis of the MSRE with ^{233}U Fuel," ORNL-TM-2997, April 1970.
7. C. D. Martin, Jr., *Instrumentation and Controls Div. Ann. Progr. Rept. Sept. 1, 1970*, ORNL-4620, p. 55.
8. R. C. Steffy, Jr., *Frequency Response Testing of the Molten-Salt Reactor Experiment*, ORNL-TM-2823 (March 1970).
9. D. N. Fry, et al., *Measurement of Helium Void Fraction in the MSRE Fuel Salt Using Neutron Noise Analysis*, ORNL-TM-2318 (Aug. 27, 1968).
10. J. C. Robinson, D. N. Fry, *Determination of the Void Fraction in the MSRE Using Small Induced Pressure Perturbation*, ORNL-TM-2318 (Feb. 6, 1969).
11. *Conceptual Design Study of a Single-Fluid Molten-Salt Breeder Reactor*, ORNL-4541 (1971), pp. 74-83.
12. W. H. Sides, Jr., *MSBR Control Studies*, ORNL-TM-2489 (June 2, 1969).
13. W. H. Sides, Jr., *Control Studies of a 1000-MW(e) MSBR*, ORNL-TM-2927 (May 18, 1970).
14. W. H. Sides, Jr., *MSBR Control Studies: Analog Simulation Program*, ORNL-TM-3102 (May 1971).
15. O. W. Burke, *Hybrid Computer Simulation of the MSBR*, ORNL-TM-3767 (May 5, 1972).

16. C. K. Sanathan and A. A. Sandberg, University of Illinois, Chicago, Illinois, and F. H. Clark, O. W. Burke, and R. S. Stone, ORNL, "Transient Analysis and Design Evaluation of a Once-Through Steam Generator with the Aid of a Hybrid Computer," submitted for publication in *Nuclear Engineering and Design*.
17. J. R. Tallackson, *MSRE Design and Operations Report, Part II, Nuclear and Process Instrumentation*, ORNL-TM-729 (February 1968), p. 228.
18. *MSR Program Semiann. Progr. Rept. Feb. 28, 1970*, ORNL-4548, p. 64.
19. J. R. Tallackson, R. L. Moore, and S. J. Ditto, *Instrumentation and Controls Development of Molten-Salt Breeder Reactors*, ORNL-TM-1856 (May 22, 1971).

13. MOLTEN-SALT TEST REACTOR MOCKUP

13.1 INCENTIVE FOR CONSTRUCTION AND OPERATION OF REACTOR MOCKUP

The development work outlined in the earlier sections of this program plan is aimed at providing the technology required for design of components for a molten-salt test reactor. However, a number of important aspects related to test-reactor design and operation cannot be fully demonstrated by the outlined work. For this reason, it appears desirable to design, construct, and operate a mockup consisting of important portions of the test reactor. The systems to be mocked up would consist largely of the primary and secondary circuits for the reactor plus portions of the steam-raising equipment. The mockup would be designed for operation in principally an isothermal manner and would be used for testing of full-scale prototypic components for the test reactor. It is intended that the test reactor mockup would be operated in a parallel manner to other component development facilities, such as the Steam Generator Model Test Installation, in which scaled-down versions of test reactor components would be tested over the full range of anticipated operating conditions.

Other benefits which would accrue from work associated with the test reactor mockup include obtaining experience during the design and construction phases which would be directly applicable to the test reactor, providing an opportunity for testing of remote maintenance equipment and techniques prior to test reactor operation, and allowing an opportunity for operator training in support of the test reactor.

13.2 SCHEDULE AND REQUIRED FUNDING

Conceptual design of the test reactor mockup will be completed during FY 1979, and FY 1981 authorization for final design and construction will be requested. Detailed design of the MSTR mockup will be completed by the end of FY 1983, and operation will begin during FY 1984. The estimated cost of the facility is \$50 million. Operating fund requirements for the test reactor mockup through FY 1985 are shown in Table 13.2.

Table 13.2. Operating fund requirements for molten-salt test reactor mockup
(costs in 1000 dollars)

	Fiscal year								
	1978	1979	1980	1981	1982	1983	1984	1985	1986
Conceptual design		630							
Program assistance during design and construction			700	850	1500				
Operation						2500	3000	3000	
Total operating funds		630	700	850	1500	2500	3000	3000	

14. MOLTEN-SALT TEST REACTOR

A number of important questions related to the design of molten-salt breeder reactors can be answered only through the construction and operation of a test reactor. These include the need for additional reactor operating and maintenance experience under conditions more closely resembling molten-salt power reactors in order to obtain improved estimates for the availability and maintenance costs of molten-salt breeder reactors, the need for operation of a continuous processing system in which representative quantities of protactinium and fission products are present, and the need for an improved definition of the behavior and distribution of noble-metal fission products in a reactor system. Finally, there is the need for the ultimate demonstration that a satisfactory material of construction for the reactor primary circuit has been developed and the need for obtaining experience with design, fabrication, and operation of larger reactor components.

Neither the optimum size nor complexity of the test reactor has been determined at this time. If at all possible, the test reactor should be sufficiently large that experience can be obtained with components that are full-scale for a demonstration reactor. It is anticipated that the preliminary conceptual design studies outlined in Section 8 of this program plan will lead to a clear definition of the design and operational requirements for the test reactor. Final design of the system will be completed by the end of FY 1985, and operation should begin early in FY 1989. The estimated cost for design and construction of the test reactor is \$450 million. This estimate should be considered to be very preliminary, since it is not supported by detailed design or cost estimation. Operating fund requirements associated with the test reactor through FY 1985 are shown in Table 14.1.

Table 14.1. Operating fund requirements for molten-salt test reactor
(costs in 1000 dollars)

	Fiscal year									
	1978	1979	1980	1981	1982	1983	1984	1985	1986	
Conceptual design	2000	4750								
Program assistance during design and construction			2500	2650	2500	3000	3500	4000		
Total operating funds	2000	4750	2500	2650	2500	3000	3500	4000		

15. MOLTEN-SALT DEMONSTRATION REACTOR

Conceptual design of a molten-salt demonstration reactor would be initiated during FY 1982 in support of a request for obtaining FY 1985 authorization for the design and construction of a demonstration reactor.